

EN  
£



# KING TONY

*Enjoy your work*



# BEST OF

# 2026



# Sponsor & Partnership

Racing pilots, passionate about mechanics, have chosen the KING TONY® brand to help them on a daily basis and make their repairs a real pleasure.



**Charlie Herbst  
HC RACING 86**



**Kevin Rohrscheidt - KEEPONRACING**



KING TONY® is developing its international brand image. To strengthen our position in the market, we are increasing the visibility of the brand through motorsport.



**Matteo Chatillon - Maxence Cornuau  
MLC Racing**

**TATI Team  
Beringer Racing**



**Bonduel Racing ASBL**



**Romain Dumas  
RD Limited**



# Brand vision

Since 1984, KING TONY® has been committed to providing professional tools. We have always focused on a quality offer, ensuring that this quality meets the work requirements of our customers. Completing a mission in a professional manner is the goal of every mechanic, but completing it easily and perfectly offers the feeling of an even greater personal accomplishment. Thus, every mechanic can really enjoy his work. As a result, we aim to let every mechanic know that when he uses KING TONY® professional tools, he can quickly, easily and perfectly finish his work. He can feel confident and appreciate what he is doing. To achieve this goal, we will continue to provide easy-to-use, manageable, time-saving tools. Our vision for the future is to tell every mechanic who uses KING TONY® tools: «Enjoy your work». It's the very meaning of using good tools to do a good job and feel a real pleasure when working. Why not fully find your pleasure in your doing your job? Use the professional KING TONY® tools and start living the experience.

• Quality • Innovation • Health • Enjoyment

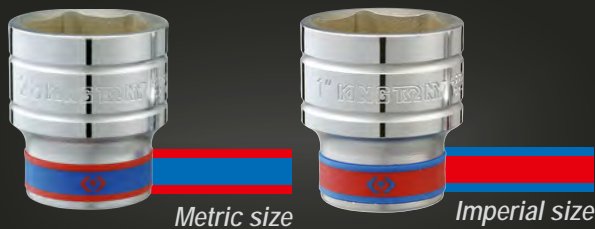

## Patented design

Our patented color identification system is a clever innovation in the history of tooling. To facilitate tool recognition, KING TONY® has created two colors: BLUE for metric units, RED for imperials.

## Precise dimensions

Aware of the importance of having a precise dimension for a professional, KING TONY® uses all its know-how to minimize the tolerance of each tool.



**1062**  
SERIES I-BEAM  
technology

## Innovations

Every year sees the release of many improved tools. KING TONY® selects the most useful ideas and ingenious functions to develop new products in the respect of an exceptional quality and a controlled cost. Every innovation is designed, above all, for the comfort of users.

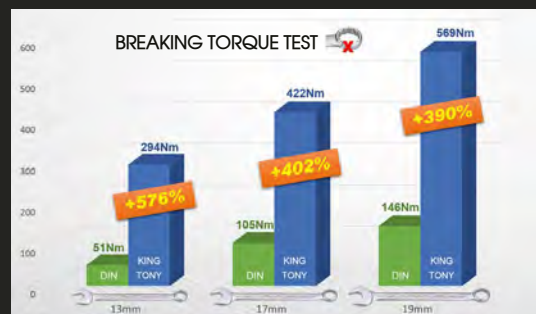

Test of the breaking torque of KING TONY®'s 13, 17 and 19 mm combination wrenches, compared to DIN 3113. Produced by CETIM (independent certification organization).

## The required quality

Only the best tools come out of our factories. Indeed, KING TONY® imposes its own standard: at least 30% above the DIN standard for hand tools, and 50% minimum for impact tools.

# SUMMARY

Hand sockets .....	6
Impact sockets .....	18
Pneumatic Impact Wrenches .....	20
Wrenches .....	24
Pliers .....	31
Screwdrivers, L-wrenches and bits .....	36
Hammers and striking tools .....	44
Pipe tools .....	48
Tools for electronics and electricity .....	50
1000 V insulated tools .....	57
 <b>PENTA</b> Electrical safety equipment .....	62
Workshop tools .....	66
Lighting .....	72
Storage and tool sets .....	76
Torque control .....	118
Pullers .....	122
Automotive tools .....	130
Hydraulic - Lifting .....	150

## *Branding to Target Users*

The KING TONY® brand has specialized in professional tools and has become «the expert in tools with the best service». In addition to that, our marketing strategy is very effective. It is based on always keeping in mind the concept of «customer priority» .



# RATCHETS AND ARTICULATED HANDLES

## RATCHETS

- Materials:  
- body in Cr-V  
- square drive in Cr-Mo

- Finishes:  
- polished and chrome body  
- black phosphate square drive

30% above the DIN standards



2 PC.



Protection against dust and condensation

### I-beam

**7773GS** £49.84<sup>B</sup>

1/4" & 1/2" DR I-BEAM DUST-PROOF RATCHET SET



Quick release of the socket



Steel retainer ball



Reversible



I-beam design



Non-slip PP+TPR handle

**277355GS** 140 mm £26.70<sup>B</sup>



**477310GS** 250 mm £30.26<sup>B</sup>



MINI RATCHET

2 PC.

**276B0225** 87.6 mm £28.48<sup>B</sup>

1/4" MINI BIT HOLDER & SOCKET HOLDER RATCHET SET



12 points bit holder

Contents

276B35

770225



Quick release of the socket

123

**275245G** 114 mm £27.59<sup>B</sup>

MINI SWIVEL HEAD RATCHET WITH ARTICULATED HANDLE



Articulated handle can be used in a T shape.

### REVERSIBLE RATCHET



**275955G** 140 mm

£27.59<sup>B</sup> 114

**375908G** 200 mm

£24.92<sup>B</sup> 387

**475910G** 262 mm

£27.59<sup>B</sup> 540

### REVERSIBLE RATCHET



Quick release of the socket



**277155G** 130 mm

£21.36<sup>B</sup> 122



**477110G** 250 mm

£28.48<sup>B</sup> 623

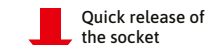

Quick release of the socket

**677820FS** 500 mm £86.33<sup>B</sup>

REVERSIBLE RATCHET



2.61



**877932F** 800 mm £177.11<sup>B</sup>

REVERSIBLE RATCHET



4.40

**New**



5.19

**677802MR** 500 ~ 1168 mm £132.61<sup>B</sup>

3/4" REVERSIBLE RATCHET + INTERCHANGEABLE EXTENSION HANDLE 668MM



Heavy duty



Telescopic



Quick release of the socket



Steel retainer ball



Reversible



Non-slip PP+TPR handle

477322GS

£79.21<sup>B</sup>

1/2" TELESCOPIC RATCHET

Higher torque, less effort. Extra long lever for increased power: max 550 mm. 700 Nm torque value, which far exceeds the standard.



1.28



IP51 Protection against dust and condensation

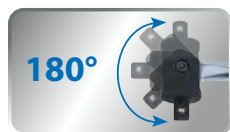

446124G

450 ~ 600 mm



£40.94<sup>B</sup>

ARTICULATED AND EXTENDABLE HANDLE

1.18



646240P

1020 mm



£105.91<sup>B</sup>

ARTICULATED HANDLE

3.90

846240P

1020 mm



£119.26<sup>B</sup>

ARTICULATED HANDLE

3.95

445318F



445315F

I-beam

445315F

375 mm



£25.81<sup>B</sup>

630

445318F

450 mm



£29.37<sup>B</sup>

708

ARTICULATED HANDLE



Reinforced U shape head



180° swivelling square drive



Steel retainer ball



I-beam design

3 PC.

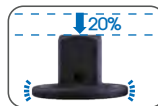

9403PP

£31.68<sup>B</sup>

MAGNETIC EXTRA-THIN MULTIPLIER ADAPTER SET

0.15

Best suited for limited space or when regular adapter does not meet requirements. Magnetic adapter holds sockets perfectly. Extra-thin design (20% thinner than a standard model).



Contents

		L mm
	2883	1/4" F x 3/8" M 14.5
	3884	3/8" F x 1/2" M 19
	4886	1/2" F x 3/4" M 28

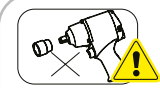
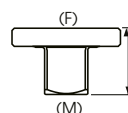

Do not use these sockets with an impact wrench.



6 PC.  
1.31

78106	£25.81 <sup>B</sup>
<b>1/4" + 3/8" + 1/2" + 3/4" DR. ADAPTER SET</b>	
Contents	F M
2813	1/4" → 3/8"
4813	1/2" → 3/8"
3812	3/8" → 1/4"
4816	1/2" → 3/4"
3814	3/8" → 1/2"
6814	3/4" → 1/2"



**2793** 1/4" 31 mm £8.90<sup>B</sup>  
1/4" UNIVERSAL JOINT 18

**4793** 1/2" 59 mm £8.90<sup>B</sup>  
1/2" UNIVERSAL JOINT 125

20° recess angle  
Short model for better access in narrow areas.  
Chromed polished finish  
Ball point type universal joint & with hex locking design.

## EXTENSIONS

easy access swivel angle 6°

**229304** 100 mm 1/4" £5.79<sup>B</sup> 45

**229306** 150 mm 1/4" £6.85<sup>B</sup> 140

**625104** 100 mm 3/4" £13.17<sup>B</sup> 400

**625108** 200 mm 3/4" £18.60<sup>B</sup> 730

**625116** 400 mm 3/4" £26.43<sup>B</sup> 1.36

**422118** 450 mm 1/2" £16.47<sup>B</sup> 550

**422124** 600 mm 1/2" £19.58<sup>B</sup> 680

**422130** 750 mm 1/2" £28.48<sup>B</sup> 860

**422136** 900 mm 1/2" £30.26<sup>B</sup> 1.03

**3893EW** 340 mm 1/4" 3/8" £79.21<sup>B</sup>

3 PC.

**1/4" AND 3/8" RATCHET EXTENSION**

Comes with two interchangeable 1/4" and 3/8" square drives.  
The chain-driven mechanism improves durability and smoothness of operation.  
Designed to move away from the work area to facilitate tightening and loosening.  
Maximum authorized torque: 130 Nm (96 ft lb).

410

## SOCKETS & SOCKET RAILS

LIFETIME GUARANTEE

**CHROME VANADIUM**

Rubber ring on all the 1/2", 3/4" and 1" sockets

**METRIC SIZE**  
At least **30%** above the DIN standards

**IMPERIAL SIZE**  
At least **30%** above the ANSI standards

### THINK ABOUT IT!



11 PC.

**91000M** £15.58<sup>B</sup>

**MAGNETIC HEXAGONAL INSERT SET FOR METRIC SOCKETS** 42

For 6-point or 12-point metric sockets.

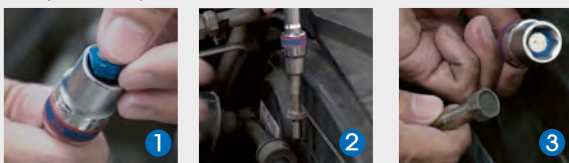

22 PC.

**P91000M** 1/2" £48.06<sup>B</sup>

- 4335M : 8, 10, 11, 12, 13, 14, 15, 16, 17, 18, 19
- 91000M : 8, 10, 11, 12, 13, 14, 15, 16, 17, 18, 19

 2330S : 5/32", 3/16", 7/32", 1/4", 9/32", 5/16", 11/32", 3/8", 7/16", 15/32", 1/2"	<b>2011SR</b>   <b>11 PC.</b> £16.91 <sup>B</sup>  620
 2033 : T8, T9, T10, T15, T20, T25, T27, T30, T40	<b>2109PR</b>   <b>9 PC.</b> £16.02 <sup>B</sup>  170
 2033 : T8, T9, T10, T15, T20, T25, T27, T30, T40 - 2275M : E4, E5, E6, E7, E8	<b>2114TR</b>    <b>14 PC.</b> £23.14 <sup>B</sup>  300
 2035 : H3, H4, H5, H6, H7, H8, H10	<b>2127PR</b>   <b>7 PC.</b> £12.46 <sup>B</sup>  150
 2035S : H1/8, H5/32, H3/16, H7/32, H1/4, H5/16, H3/8	<b>2127SR</b>   <b>7 PC.</b> £14.24 <sup>B</sup>  150
 2335M : 4, 5, 6, 7, 8, 9, 10, 11, 13	<b>2509MR</b>   <b>9 PC.</b> £10.32 <sup>B</sup>  200
 3023 : T15, T20, T25, T27, T30, T40, T45, T50	<b>3118PR</b>   <b>8 PC.</b> £32.04 <sup>B</sup>  340
 3375M : E4, E5, E6, E7, E8, E11 - 4375M : E10, E12, E14, E16, E18, E20	<b>7113PR</b>    <b>12 PC.</b> £35.60 <sup>B</sup>  350
 4330S : 3/8", 7/16", 1/2", 9/16", 11/16", 3/4", 13/16", 7/8"	<b>4010SR</b>   <b>8 PC.</b> £23.14 <sup>B</sup>  640
 402B : M16 - 4026 : M8, M10, M12, M14	<b>4105PR</b>    <b>5 PC.</b> £32.93 <sup>B</sup>  570
 4025 : H6, H7, H8, H10, H12, H14, H17, H19	<b>4108PR10</b>   <b>8 PC.</b> £36.49 <sup>B</sup>  960
 4335M : 10, 12, 13, 14, 17, 19, 21, 22	<b>4510MR</b>   <b>8 PC.</b> £22.25 <sup>B</sup>  640
 4049 : M9, M10, M12, M13, M14, M16	<b>4116PR</b>   <b>6 PC.</b> £59.63 <sup>B</sup>  380

**New**

  
 6025 : H14, H17, H19, H22  
**6104PRD1**    
**4 PC.** £44.50<sup>B</sup>  
 1.35

**New**

  
 6023 : T60, T70, T80, T90, T100  
**6105PRD1**    
**5 PC.** £87.22<sup>B</sup>  
 1.68

**New** **10 PC.**

  
 330 mm

Quick and easy socket removal thanks to a lever system.

 173

**87413B10**   £20.47<sup>B</sup>

**MAGNETIC FLIP LOCK SOCKET RAIL 1/2"**

Securely holds 10 1/2" sockets thanks to secure clips.  
 Magnetic base with soft coating to protect surfaces.  
 Finish : anodised aluminium



Versatile mounting options - hang or attach magnetically for maximum convenience



# SOCKET SETS



Rubber ring on all the 1/2", 3/4" and 1" sockets



METRIC SIZE  
At least **30%** above the DIN standards



IMPERIAL SIZE  
At least **30%** above the ANSI standards



25 PC.

**2525MRE** <sup>1/4"</sup> £ 34 <sup>B</sup>

203 x 93 x 43 mm

Contents 0.55

	2335M	4, 4.5, 5, 5.5, 6, 7, 8, 9, 10, 11, 12, 13
	1025P	PH2, PH2
	1025H	H5, H6
	1025T	T10, T15, T20, T25, T30, T40
	2142	222104
	277155G	



26 PC.

**2526SR02** <sup>1/4"</sup> £ 64.08 <sup>B</sup>

244 x 118 x 37 mm

Contents 1.38

	2335S	5/32", 3/16", 7/32", 1/4", 9/32", 5/16", 11/32", 3/8", 7/16", 15/32", 1/2"
	2235S	5/32", 3/16", 7/32", 1/4", 9/32", 5/16", 11/32", 3/8", 7/16", 1/2"
	222102, 222104	
	275955G	2792 2813



31 PC.

**2531MR03** <sup>1/4"</sup> £ 77.43 <sup>B</sup>

280 x 130 x 41 mm

Contents 1.60

	2335M	4, 4.5, 5, 6, 7, 8, 9, 10, 11, 12, 13
	2033	T8, T9, T10, T15, T20, T25, T27, T30
	2035	H3, H4, H5, H6, H8, H10
	275955G	257145
	2792	2179DF
		222103, 222106



39 PC.

**2539MRV04** <sup>1/4"</sup> £ 61.41 <sup>B</sup>

199 x 161 x 56 mm

Contents 1.25

	2335M	5, 6, 7, 8, 9, 10, 11, 12, 13, 14
	1025S	4.0 x 0.5, 5.5 x 0.8, 6.5 x 1.2
	1025P	PH1, PH2
	1025Z	PZ2
	1025U	T7H, T8H, T9H, T10H, T15H, T20H, T25H, T27H, T30H, T40H
	1025H	H1.5, H2, H2.5, H3, H4, H5, H6
	1317012PN	PH1 PH2
	1317046SN	4.0 6.0
	1317057SN	5.0 7.0
	770225	215506
	2155DF	



39 PC.

ATOM Series



**2539MR01AM** <sup>1/4"</sup> £ 69.42 <sup>B</sup>

175 x 98.5 x 55 mm

Contents 0.86

	2335M	5, 5.5, 6, 7, 8, 9, 10, 11, 12, 13, 14
	1025P	PH1, PH2, PH3
	102512P	PH2
	1025Z	PZ1, PZ2, PZ3
	1025T	T10, T15, T20, T25, T27, T30, T40
	1025S	4.0, 5.0, 6.0
	1025H	H2.5, H3, H4, H5, H6
	(I-beam) 277355GS	
	2176DF	
	2141	2793 222102, 222104



44 PC.

**2044SRE** <sup>1/4"</sup> £ 97.01 <sup>B</sup>

Case 820002K (389 x 185 x 66 mm)  
EVA #10 (375 x 140 mm)

Contents 1.62

	2330S	5/32", 3/16", 7/32", 1/4", 9/32", 5/16", 11/32", 3/8", 7/16", 15/32", 1/2"
	2235S	5/32", 3/16", 7/32", 1/4", 9/32", 5/16", 11/32", 3/8", 7/16", 1/2"
	5025H	H3/64", H1/16", H5/64", H3/32", H7/64", H1/8", H9/64", H5/32"
	1025S	3.0, 4.5, 5, 6.5, 8
	1025P	PH0, PH1, PH2, PH3
		222302, 222304
	275206G	2792 2142
	2178DF	

\* The guarantee is unlimited in time, excluding 1/4" screw bits.

275955G + 2176DF



2551MR03

1/4"

£74.76<sup>B</sup>

47 PC.

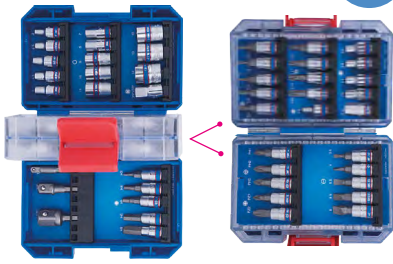

244 x 118 x 37 mm

51 PC.

Contents

1.43

2335M	4, 4.5, 5, 5.5, 6, 7, 8, 9, 10, 11, 12, 13, 14
1025S	3.0, 4.0, 5.0, 6.0
1025P	PH1, PH2, PH2, PH3
1025Z	PZ1, PZ2, PZ2, PZ3
1025T	T10, T15, T20, T25, T27, T30, T40
1025U	T10H, T15H, T20H, T25H, T27H, T30H, T40H
1025H	H3, H4, H5, H6
222302, 222304	
275955G	2176DF
2792	770225 75363 2813

2547MREB

1/4"

£72.98<sup>B</sup>

150 x 106 x 83 mm

Contents

1.0

2335M	4, 4.5, 5, 5.5, 6, 7, 8, 9, 10, 11, 12, 13, 14
2375M	E4, E5, E6, E7, E8, E10
2031	PH1, PH2, PH3
2032	3.5, 4, 5.5, 6.5, 8
2033	T8, T9, T10, T15, T20, T25, T27, T30, T40
2035	H3, H4, H5, H6, H8
2038	PZ1, PZ2
2813	1/4" F x 3/8" M
770250	1/4"
770350	3/8"
770450	1/2"

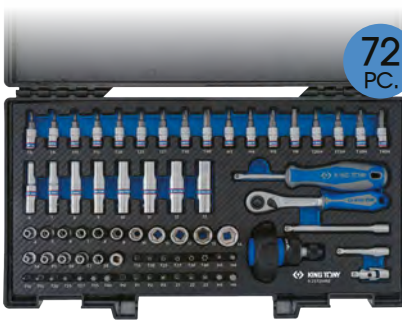

72 PC.

2572MRE

1/4"

£145.96<sup>B</sup>

Case 820003K (389 x 230 x 66 mm)  
EVA #8 (375 x 187 mm)

Contents

2.06

2335M	4, 5, 6, 7, 8, 9, 10, 11, 12, 13, 14
2235M	6, 7, 8, 9, 10, 11, 12, 13
2375M	E4, E5, E6, E7, E8
2033	T8, T9, T10, T15, T20, T25, T27, T30, T40
2035	H3, H4, H5, H6
2037	T20, T25, T30, T40
1025P	PH0, PH1, PH2, PH3
1025Z	PZ1, PZ2, PZ3
1025H	H3, H4, H5, H6
1025T	T10, T15, T20, T25, T27, T35, T40
1025U	T15H, T20H, T25H, T27H, T30H, T40H
222302, 222304	
277355GS	2746
2178DF	2792 2142



91 PC.

5092CR

1/4" 3/8"

£177.11<sup>B</sup>

445 x 187 x 50 mm

Contents

4.4

2335M	4, 4.5, 5, 5.5, 6, 7, 8, 9, 10, 11, 12, 13
2335S	5/32", 3/16", 7/32", 1/4", 9/32", 5/16", 11/32", 3/8", 7/16", 1/2"
2235M	4, 4.5, 5, 5.5, 6, 7, 8, 9, 10, 11, 12, 13
2235S	5/32", 3/16", 7/32", 1/4", 9/32", 5/16", 11/32", 3/8", 7/16", 1/2"
3330M	8, 9, 10, 11, 12, 13, 14, 15, 16, 17, 18, 19, 20, 21, 22
2015SX	1/8, 3/16, 7/32, 1/4, 5/16, 3/8
2015MX	H3, H4, H5, H6, H8, H10
2011X	PH1, PH2, PH3, PH4
1115	H1.5, H2, H2.5 2561
376908F	257145 245205F 2179DF 3792
3812	363516 222102, 222104 322103, 322106 3840

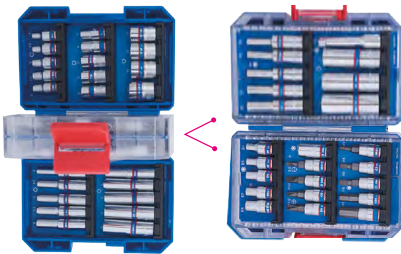

48 PC.

2549MREB

1/4"

£83.66<sup>B</sup>

150 x 106 x 83 mm

Contents

1.28

2335M	4, 4.5, 5, 5.5, 6, 7, 8, 9, 10 (x2), 11, 12, 13, 14
2235M	4, 4.5, 5, 5.5, 6, 7, 8, 9, 10, 11, 12, 13, 14
2275M	E4, E5, E6, E7, E8
2375M	E4, E5, E6, E7, E8, E10
2031	PH1, PH2
2032	4, 5.5
2035	H3, H4, H5, H6, H8
222102	



36 PC.

3534MR01

3/8"

£102.35<sup>B</sup>

372 x 153 x 40 mm

Contents

3.1

3335M	6, 7, 8, 9, 10, 11, 13, 14, 17, 19
3375M	E4, E5, E6, E7, E8, E10, E12, E14, E16, E18
3023	T8, T9, T10, T15, T20, T25, T27, T30, T40, T45
375908G	345208F 3792
357108	322103, 322106



23 PC.

3523MRE09

3/8"

£88.11<sup>B</sup>

Case 820002K (389 x 185 x 66 mm)  
EVA #10 (375 x 140 mm)

Contents

2.43

3335M	6, 7, 8, 9, 10, 11, 12, 13, 14, 15, 16, 17, 19, 21, 22, 23, 24
375908G	
329303, 329306	3792
357108	345208G

\* The guarantee is unlimited in time, excluding 1/4" screw bits.





20 PC.

**7120PR** 3/8" 1/2" £56.07<sup>B</sup>

296 x 130 x 41 mm

Contents		1.79
	3375M E6, E7, E8, E10	
	4375M E12, E14, E16, E18, E20	
	3023 T10, T15, T20, T25, T27	
	4023 T30, T40, T45, T50, T55	
	4813	



60 PC.

**7560MRE** 1/4" 1/2" £234.07<sup>B</sup>

**7560MRE01** 1/4" 1/2" £234.07<sup>B</sup>

Case 820011K (422 x 372 x 92mm)  
EVA #9 (375 x 280 mm)

Contents		6.24
	2335M 4, 5, 5.5, 6, 7, 8, 9, 10, 11, 12, 13, 14	
	4335M 10, 11, 13, 14, 15, 16, 17, 18, 19, 20, 21, 22, 24, 27, 30, 32	
	1025S 3, 4.5, 5, 6.5, 8	
	1025P PH0, PH1, PH2, PH3	
	1025Z PZ1, PZ2, PZ3	
	1025U T10, T15, T20, T25, T27, T30, T40	
	222302, 222304	
	425105, 425106	2745
<b>7560MRE</b>	475910G	
<b>7560MRE01</b>	477110G	
	276A04G	213312DF
	445215F	457212
	2813	2792 4791 2142



62 PC.

**9564MR01** 1/4" 3/8" 1/2" £238.52<sup>B</sup>

476 x 282 x 57 mm

Contents		7.45
	4335M 12, 13, 14, 15, 16, 17, 18, 19, 20, 21, 22, 23, 24, 27, 30, 32	
	3335M 8, 9, 10, 11, 12, 13, 14, 15, 17, 19	
	2335M 4, 4.5, 5, 6, 7, 8, 9, 10, 11, 12	
	3235M 10, 13, 17, 19	
	3375M E10, E12, E14, E16, E18	
	3023 T20, T25, T27, T30, T40	
	3665 16, 20.8	
	425106	222104
	475910G	375908G 275955G 457212
	2792	3792 4791



\* The guarantee is unlimited in time, excluding 1/4" screw bits.





55 PC.

**7555MRE10** 1/4" 1/2" £149.52<sup>B</sup>

Case 820003K (389 x 230 x 66 mm)  
EVA #8 (375 x 187 mm)

Contents		3.80
2335M	5.5, 6, 7, 8, 9, 10, 11, 12, 13, 14	
4335M	10, 11, 12, 13, 14, 15, 16, 17, 18, 19, 21, 22, 24, 27, 30, 32	
1025S	4.5, 6.5, 8	
1025P	PH1, PH2, PH3	
1025Z	PZ1, PZ2, PZ3	
1025U	T10, T15, T20, T25, T27, T30, T40	
1025H	H3, H4, H5, H6, H7	
275955G	475910G	
2178DF	2792 2142	
222102, 222104	422305	



Evawave tray suitable for tool trolley drawers



81 PC.

**7581MRO1** 1/4" 1/2" £281.24<sup>B</sup>

422 x 360 x 110 mm

Contents		7.14
2335M	4, 4.5, 5, 5.5, 6, 7, 8, 9, 10, 11, 12, 13	
4335M	10, 11, 12, 13, 14, 15, 17, 19, 22, 24	
4635	16, 20, 8	
1025H	H3, H4, H5, H6, H7, H8	
1025T	T20, T25, T30, T40	
1060	6, 7, 8, 10, 12, 13, 14, 15, 17, 19	
1120MR	H1.5, H2, H2.5, H3, H4, H5, H6, H8, H10	
1147R	T10H, T15H, T20H, T25H, T27H, T30H, T40H	
1421	PH1 x 80, PH2 x 100	
1422	4 x 100, 5.5 x 125, 6.5 x 150	
276A04G	475910G	
222104	425105	
2792	4791 75060	
631106	611106	
651610C		
7610405	7621505 7640406	
782150OS	79831	
9DC22		



110 PC.

**7511MR** 1/4" 1/2" £217.16<sup>B</sup>

422 x 275 x 85 mm

Contents		6.9
2335M	4, 4.5, 5, 5.5, 6, 7, 8, 9, 10, 11, 12, 13, 14	
2235M	6, 7, 8, 9, 10, 11, 12, 13	
2375M	E4, E5, E6, E7, E8	
4235M	14, 15, 17, 19, 22	
4335M	10, 11, 12, 13, 14, 15, 16, 17, 18, 19, 20, 21, 22, 24, 27, 30, 32	
4375M	E10, E11, E12, E14, E16, E18, E20, E24	
4635	16, 20, 8	
2031	PH1, PH2	2038 PZ1, PZ2
2032	4, 5.5, 6.5	
2033	T8, T10, T15, T20, T25, T27, T30	
2035	H3, H4, H5, H6	
1836P	PH3, PH4	1836H H14
1836S	8x1.2, 10x1.6, 12x2.0	
1832T	T40, T45, T50, T55, T60	
1832H	H7, H8, H10, H12	
1836Z	PZ3, PZ4	
1115*	H1.5, H2, H2.5	
277155G	477110G	
2745	2178DF 2792 4791	
222102, 222104	425105	
422210	257145	
770225	414810S 3824	



103 PC.

**7503MRO1** 1/4" 1/2" £318.62<sup>B</sup>

422 x 360 x 110 mm

Contents		9.24
2335M	4, 4.5, 5, 5.5, 6, 7, 8, 9, 10	
4335M	8, 9, 10, 11, 12, 13, 14, 15, 16, 17, 18, 19, 20, 21, 22, 23, 24, 27, 30, 32	
4635	16, 20, 8	
2375M	E4, E5, E6, E7, E8, E10	
4375M	E11, E12, E14, E16, E18	
1025T	T15, T20, T25, T27, T30, T40, T45, T50	
1025H	H2, H2.5, H3, H4, H5, H6, H7, H8, H10	
1025M	M4, M5, M6, M8, M10	
2221	75, 150	
4251	125, 250	
4223	55	
1062	8, 10, 11, 12, 13, 14, 15, 16, 17, 18, 19, 21, 22, 24	
1930	8x10, 11x13, 12x14, 17x19	
1421	PH1 x 80, PH2 x 100	
1422	5.5 x 125, 6.5 x 150	
277155G	477110G	
257145	457210	
2178DF		
2792	4791 2142	
361108R	611107	
212826		

\* The guarantee is unlimited in time, excluding 1/4" screw bits.





**9 PC.**  
198 x 105 x 32 mm  
Contents: T20, T25, T27, T30, T40, T45, T50, T55, T60  
4023

**4109PR** 1/2" £48.95<sup>B</sup>



**9 PC.**  
198 x 105 x 32 mm  
Contents: T20, T25, T27, T30, T40, T45, T50, T55, T60  
4033

**4119PR** 1/2" £53.40<sup>B</sup>



**9 PC.**  
198 x 105 x 32 mm  
Contents: H3, H4, H5, H6, H7, H8, H10, H12, H14  
4025

**4110PR** 1/2" £48.95<sup>B</sup>



**9 PC.**  
198 x 105 x 32 mm  
Contents: H4, H5, H6, H7, H8, H10, H12, H14, H17  
4035

**4120PR** 1/2" £53.40<sup>B</sup>



**20 PC.**  
198 x 105 x 32 mm  
Contents: T20, T25, T27, T30, T40, T45, T50, T55, T60  
4033

**4220MR** 1/2" £110.36<sup>B</sup>

445 x 135 x 50 mm  
Contents: 4330MR (8, 9, 10, 11, 12, 13, 14, 15, 16, 17, 18, 19, 21, 22, 24, 27), 475910G, 4791, 425105, 425110



**21 PC.**  
Case 820003K (389 x 230 x 66 mm)  
EVA #8 (375 x 187 mm)  
Contents: 4335M (10, 11, 12, 13, 14, 15, 16, 17, 18, 19, 21, 22, 24, 27, 30, 32), 477910B, 412111G, 458312, 425110, 4791

**4321MRE** 1/2" £123.71<sup>B</sup>



**23 PC.**  
Case 820003K (389 x 230 x 66 mm)  
EVA #8 (375 x 187 mm)  
Contents: 4335M (8, 9, 10, 11, 12, 13, 14, 15, 16, 17, 18, 19, 21, 22, 24, 27, 30, 32), 425105, 425110, 4791, 477110G, 457210

**4523MRE01** 1/2" £114.81<sup>B</sup>



**25 PC.**  
422 x 372 x 92 mm  
Contents: 4235M (8, 9, 10, 11, 12, 13, 14, 15, 16, 17, 18, 19, 20, 21, 22, 23, 24, 25, 26, 27, 28, 29, 30, 32, 36)

**4335MR01** 1/2" £200.25<sup>B</sup>

Case 820003K (389 x 230 x 66 mm)  
EVA #8 (375 x 187 mm)  
Contents: 4335M (10, 11, 12, 13, 14, 15, 16, 17, 18, 19, 21, 22, 24, 27, 30, 32), 477910B, 412111G, 458312, 425110, 4791

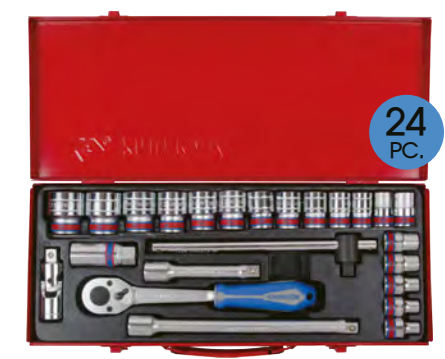

**24 PC.**  
445 x 187 x 50 mm  
Contents: 4335S (3/8", 7/16", 15/32", 1/2", 9/16", 19/32", 5/8", 11/16", 3/4", 25/32", 13/16", 7/8", 15/16", 1", 1-1/16", 1-1/8", 1-3/16", 1-1/4"), 4635 (20.8), 425105, 425110, 4791, 477910G, 457210

**4528SR** 1/2" £141.51<sup>B</sup>



**24 PC.**  
445 x 187 x 50 mm  
Contents: 4335S (5/16", 3/8", 7/16", 15/32", 1/2", 9/16", 19/32", 5/8", 11/16", 3/4", 25/32", 13/16", 7/8", 15/16", 1", 1-1/16", 1-3/16", 1-1/4"), 4635 (20.8), 422302, 477910B, 412111G, 457310, 458312

**4533SR** 1/2" £150.41<sup>B</sup>



**24 PC.**  
445 x 187 x 50 mm  
Contents: 4335M (8, 10, 11, 13, 14, 15, 16, 17, 18, 19, 20, 21, 22, 23, 24, 27, 30, 32), 425105, 425110, 4526MR03 (477910G), 4526MR04 (475910G), 445215F, 457212, 4791

**4526MR03** 1/2" £150.41<sup>B</sup>

**4526MR04** 1/2" £150.41<sup>B</sup>

Contents: 4335S (3/8", 7/16", 15/32", 1/2", 9/16", 19/32", 5/8", 11/16", 3/4", 25/32", 13/16", 7/8", 15/16", 1", 1-1/16", 1-1/8", 1-3/16", 1-1/4"), 4635 (20.8), 425105, 425110, 4791, 477910G, 457210

Contents: 4335S (5/16", 3/8", 7/16", 15/32", 1/2", 9/16", 19/32", 5/8", 11/16", 3/4", 25/32", 13/16", 7/8", 15/16", 1", 1-1/16", 1-3/16", 1-1/4"), 4635 (20.8), 422302, 477910B, 412111G, 457310, 458312

Contents: 4335M (8, 10, 11, 13, 14, 15, 16, 17, 18, 19, 20, 21, 22, 23, 24, 27, 30, 32), 425105, 425110, 4526MR03 (477910G), 4526MR04 (475910G), 445215F, 457212, 4791





24 PC.



LIMITED QUANTITY



**4524MRV04K**

1/2"

£194.91<sup>B</sup>

Case 820003K (389 x 230 x 66 mm). EVA #8 (375 x 187 mm).

Contents

5.08

	4335M	8, 10, 11, 12, 13, 14, 15, 16, 17, 18, 19, 21, 22, 23, 24, 27, 28, 30, 32
	425105, 425110	477322GS, 4793, 457212



24 PC.

**4026MR03**

1/2"

£150.41<sup>B</sup>

**4026MR04**

1/2"

£139.73<sup>B</sup>

**4026SR03**

1/2"

£150.41<sup>B</sup>

445 x 187 x 50 mm

Contents

5.95

**4026MR03 / 4026MR04**

	4330M	8, 10, 11, 13, 14, 15, 16, 17, 18, 19, 20, 21, 22, 23, 24, 27, 30, 32
--	-------	---

**4026SR03**

	4330S	5/16", 3/8", 7/16", 15/32", 1/2", 9/16", 19/32", 5/8", 11/16", 3/4", 25/32", 13/16", 7/8", 15/16", 1", 1-1/16", 1-3/16", 1-1/4"
--	-------	---

	425105, 425110
--	----------------

	4026MR03	477910G
--	----------	---------

	4026SR03	475910G
--	----------	---------

	445215F		457212		4791
--	---------	--	--------	--	------



27 PC.

**4557MR**

1/2"

£105.91<sup>B</sup>

294 x 221 x 66 mm

Contents

3.69

	4335M	8, 9, 10, 11, 12, 13, 14, 15, 16, 17, 18, 19, 20, 21, 22, 23, 24, 25, 26, 27, 28, 29, 30, 32, 33, 34, 36
--	-------	--



32 PC.

**4532MRE10**

1/2"

£203.81<sup>B</sup>

Case 820011K (422 x 372 x 92 mm)  
EVA #9 (375 x 280 mm)

Contents

6.34

	4335M	8, 9, 10, 11, 12, 13, 14, 15, 16, 17, 18, 19, 20, 21, 22, 23, 24
	4235M	10, 13, 16, 17, 18, 19, 21, 22, 24
	425105, 425110	
	477310GS	4-beam
	445315F	4-beam
	457212	4791

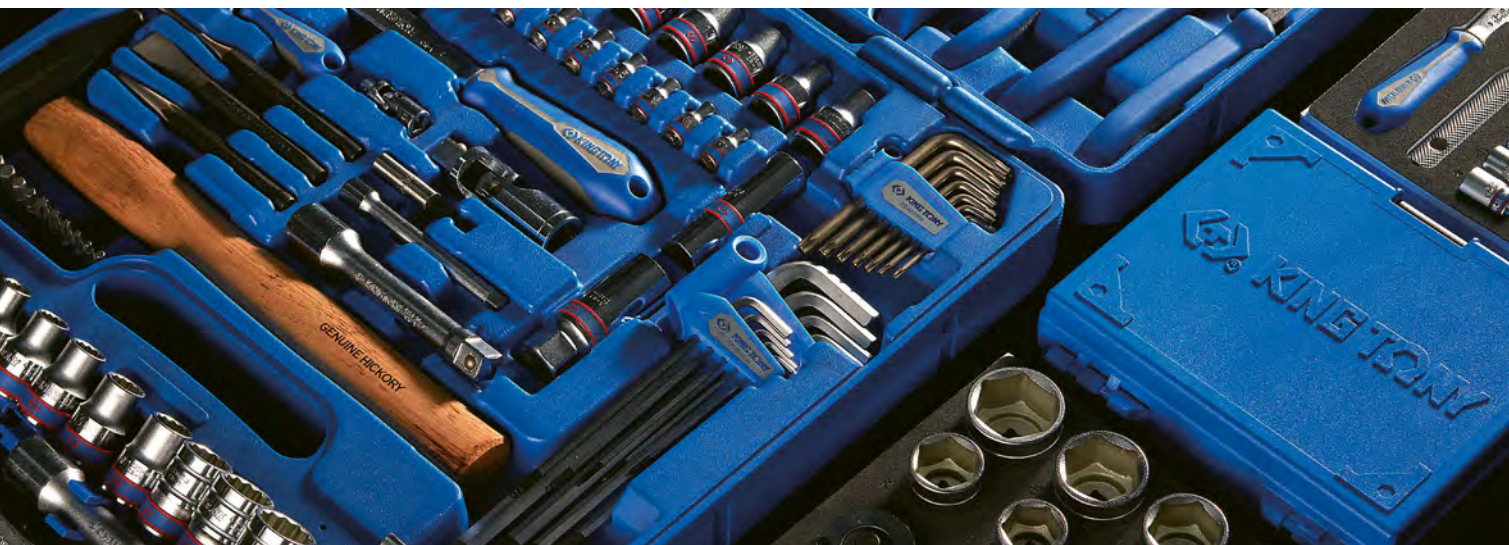



476 x 282 x 57 mm

4034MR03

1/2"

£202.92<sup>B</sup>

Contents

4034MR03	
4330M	8, 9, 10, 11, 12, 13, 14, 15, 16, 17, 18, 19, 20, 21, 22, 23, 24, 25, 26, 27, 28, 29, 30, 32
4635	16
4630	20.8
425103, 425105, 425110	
475910G	4791
445218F	457212

4534MR03

1/2"

£203.81<sup>B</sup>

4534MR03	
4335M	8, 9, 10, 11, 12, 13, 14, 15, 16, 17, 18, 19, 20, 21, 22, 23, 24, 25, 26, 27, 28, 29, 30, 32
4635	16, 20.8

8.2



4042CR02

1/2"

£208.26<sup>B</sup>

476 x 282 x 57 mm

Contents

8.5

4330M	10, 11, 12, 13, 14, 15, 16, 17, 18, 19, 20, 21, 22, 23, 24, 27, 30, 32
4330S	5/16", 3/8", 7/16", 1/2", 9/16", 19/32", 5/8", 11/16", 3/4", 25/32", 13/16", 7/8", 15/16", 1", 1-1/16", 1-1/8", 1-3/16", 1-1/4"
425105, 425110	
477910G	457212  445218F  4791



6318MR10

3/4"

£266.11<sup>B</sup>

422 x 372 x 92 mm

Contents

11

6335M	22, 24, 27, 29, 30, 32, 33, 35, 36, 38, 41, 46, 50
625104, 625108	
677920F	657220



46 PC.

4546MRE02

1/2"

£257.21<sup>B</sup>

Case 820011K (422 x 372 x 92 mm)  
EVA #9 (375 x 280 mm)

Contents

7.14

4335M	8, 9, 10, 11, 12, 13, 14, 15, 16, 17, 18, 19, 20, 21, 22, 23, 24
4023	T20, T25, T27, T30, T40, T45, T50, T55, T60
4025	H4, H5, H6, H7, H8, H10, H12, H14, H17, H19
4026	M8, M10, M12, M14
425105, 425110	
477310GS	445315F
457212	4791





16 PC.

**6316MR**

3/4"

£283.91<sup>B</sup>

537 x 177 x 78 mm

Contents

14.0

6335M 21, 22, 23, 24, 27, 30, 32, 36, 38, 41, 46, 50

625108, 625116

677920F 657220



17 PC.

**6317MR**

3/4"

£301.71<sup>B</sup>

537 x 177 x 78 mm

Contents

14.9

6335M 17, 19, 21, 22, 24, 27, 30, 32, 34, 36, 41, 46, 50, 55

625108, 625116

677920F



23 PC.

**6023MR**

£355.11<sup>B</sup>

**6023SR**

£372.91<sup>B</sup>

537 x 177 x 78 mm

Contents

17.1

**6023MR**

6330M 21, 22, 23, 24, 26, 27, 28, 29, 30, 32, 34, 35, 36, 38, 41, 46, 50

625104, 625108, 625116

677920F

**6023SR**

6330S 7/8", 15/16", 1", 1-1/16", 1-1/8", 1-3/16", 1-1/4", 1-5/16", 1-3/8", 1-7/16", 1-1/2", 1-9/16", 1-5/8", 1-3/4", 1-13/16", 1-7/8", 2"

657220 6791



24 PC.

**6224CR**

3/4"

£355.11<sup>B</sup>

537 x 177 x 78 mm

Contents

18.7

6330M 22, 24, 27, 30, 32, 36, 38, 41, 46, 50

6330S 1", 1-1/8", 1-1/4", 1-5/16", 1-3/8", 1-7/16", 1-1/2", 1-5/8", 1-3/4", 2"

625108, 625116

677920F 657220



25 PC.

**6325MR01**

3/4"

£381.81<sup>B</sup>

537 x 177 x 78 mm

Contents

18.7

6335M 19, 21, 22, 23, 24, 26, 27, 28, 29, 30, 32, 34, 35, 36, 38, 41, 46, 50, 55

625104, 625108, 625116

677820FS 657220 6791



14 PC.

**8015MR**

1"

£577.61<sup>B</sup>

660 x 205 x 108 mm

Contents

26.7

8330M 36, 41, 46, 50, 55, 60, 65, 70, 75, 80

825108, 825116

877932F 857225

# IMPACT SOCKETS

**CHROME MOLYBDENUM**



METRIC SIZE

At least **50%** above the DIN standards



IMPERIAL SIZE

At least **50%** above the ANSI standards

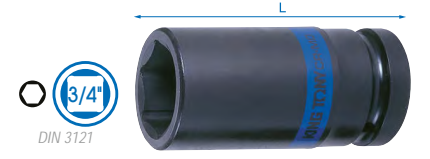

## 6435M

	mm	L mm	g	£
643524M	24	90	626	£18.69 <sup>B</sup>
643527M	27	90	623	£18.69 <sup>B</sup>
643529M	29	90	670	£18.69 <sup>B</sup>
643530M	30	90	691	£19.58 <sup>B</sup>
643532M	32	90	728	£19.58 <sup>B</sup>
643550M	50	95	1317	£37.38 <sup>B</sup>
643555M	55	100	1799	£37.38 <sup>B</sup>
643560M	60	100	2010	£34.71 <sup>B</sup>
643565M	65	100	1990	£37.38 <sup>B</sup>

Check out the full 6435M series

19 65 mm



## 6575M

Adapted to SCANIA crankshaft bearings.

	mm	L mm	g	£
657524M	E24	50	340	£24.92 <sup>B</sup>
657526M	E26	60	410	£24.03 <sup>B</sup>
657528M	E28	60	410	£24.03 <sup>B</sup>
657530M	E30	65	435	£28.48 <sup>B</sup>
657532M	E32	65	450	£28.48 <sup>B</sup>

Check out the full 8835M series

E24 E32



## 8015M

	mm	L mm	g	£
801521M	H21	80	710	£21.89 <sup>B</sup>
801522M	H22	80	720	£21.89 <sup>B</sup>
801524M	H24	80	741	£21.89 <sup>B</sup>
801527M	H27	80	776	£21.89 <sup>B</sup>
801530M	H30	80	820	£21.89 <sup>B</sup>
801532M	H32	80	851	£21.89 <sup>B</sup>
801536M	H36	80	921	£22.43 <sup>B</sup>

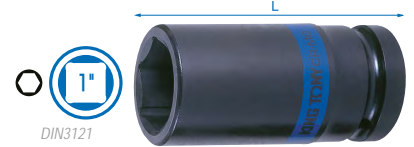

## 8835M

	mm	L mm	g	£
883532M	32	80	714	£21.36 <sup>B</sup>
883533M	33	80	748	£21.36 <sup>B</sup>

# EXTENSIONS

Security ball



**626010P** 250 mm  $\frac{3}{4}$ " £34.71<sup>B</sup>

**626013P** 330 mm  $\frac{3}{4}$ " £46.28<sup>B</sup>



## 4269 1/2" TORSION EXTENSION BAR

	Nm	L mm	g	£
42690890	90	195	192	£8.90 <sup>B</sup>
426908A0	100	195	201	£8.90 <sup>B</sup>
426908B0	110	195	217	£8.90 <sup>B</sup>
426908C0	120	195	224	£8.90 <sup>B</sup>
426908D5	135	195	238	£8.90 <sup>B</sup>
426908F0	150	195	263	£8.90 <sup>B</sup>
426908G0	160	195	304	£8.90 <sup>B</sup>
426908H5	175	195	284	£8.90 <sup>B</sup>
426908J0	190	195	331	£8.90 <sup>B</sup>
426908K0	200	195	334	£8.90 <sup>B</sup>

Also available by set!



**4269MS**  $\frac{1}{2}$ " £80.10<sup>B</sup>

Contents  $\frac{1}{2}$ " 2.8

42690890	(90 Nm)
426908A0	(100 Nm)
426908B0	(110 Nm)
426908C0	(120 Nm)
426908D5	(135 Nm)
426908F0	(150 Nm)
426908G0	(160 Nm)
426908H5	(175 Nm)
426908J0	(190 Nm)
426908K0	(200 Nm)

**10 PC.**

Torque wrench control still required.



## 9535M

	mm	L mm	g	£
953546M	46	85	2233	£83.66 <sup>B</sup>
953550M	50	85	2300	£91.67 <sup>B</sup>
953555M	55	93	2660	£94.34 <sup>B</sup>
953560M	60	95	2840	£109.47 <sup>B</sup>
953565M	65	100	3150	£124.60 <sup>B</sup>
953570M	70	103	3460	£142.40 <sup>B</sup>
953575M	75	105	3700	£142.40 <sup>B</sup>
953580M	80	105	3900	£184.23 <sup>B</sup>
953585M	85	105	4175	£186.90 <sup>B</sup>
953590M	90	110	4600	£198.47 <sup>B</sup>
953595M	95	110	7570	£291.03 <sup>B</sup>
9535A5M	105	115	8340	£372.02 <sup>B</sup>
9535A0M	100	115	8104	£311.50 <sup>B</sup>
9535B5M	115	125	9766	£548.24 <sup>B</sup>
9535B7M	117	125	9954	£488.61 <sup>B</sup>
9535B0M	110	125	9400	£431.65 <sup>B</sup>
9535C5M	125	135	11148	£645.25 <sup>B</sup>
9535COM	120	130	13090	£647.92 <sup>B</sup>
9535D5M	135	140	12423	£720.01 <sup>B</sup>
9535DOM	130	140	12423	£675.51 <sup>B</sup>
9535E0M	140	150	13570	£765.40 <sup>B</sup>
9535F0M	150	155	14270	£809.90 <sup>B</sup>

## ALLOY WHEELS SOCKETS



ANTI-MARKING  
ROTATING  
PLASTIC

HYUNDAI i30,  
HYUNDAI  
Tucson and KIA

MERCEDES BENZ  
Category C type 204, 204X,  
Category E type 211, 212,  
207, Type SLK 172,  
Category M type 164, 166,  
Category S type 221, 222,  
Category CL type 216



4  
PC.

1.06

**44904MP** 1/2" £51.62<sup>B</sup>

Contents	Ø	L mm
494515M	15	85
9BW4501	17	85.5
9BW4502	21	85.5
494522M	22	85



ANTI-MARKING  
ROTATING  
PLASTIC



3  
PC.

0.850

**44905MP** 1/2" £24.92<sup>B</sup>

Contents	Ø	L mm
494517M	17	86
494519M	19	86
494521M	21	86



3  
PC.

1.20

**4405MXL** 1/2" £70.31<sup>B</sup>

Contents	Ø	L mm
495517MX	17	150
495519MX	19	150
495521MX	21	150



EXTRA  
THIN  
WALL

3  
PC.

**4403MP** 1/2" £37.38<sup>B</sup>

Contents	Ø	L mm
4415M	17, 19, 21	

0.75

## IMPACT SOCKET RAILS



**New**



4525M : 13, 14, 17, 19, 21, 22, 24

**4401MP10** 1/2"

7  
PC.

£23.14<sup>B</sup>

0.57



4535M : 10, 11, 13, 17, 19, 22, 24, 27, 29, 30, 32

**4421MP** 1/2"

11  
PC.

£54.29<sup>B</sup>

1.60



4863 - 4575M : E10, E12, E14, E16, E18, E20 - 3575M : E5, E6, E7, E8

**7411PP** 1/2"

11  
PC.

£72.98<sup>B</sup>

0.75



4530M : 10, 11, 12, 13, 14, 15, 16, 17, 18, 19, 21, 22, 23, 24, 27, 30, 32

**4497MP** 1/2"

17  
PC.

£105.91<sup>D</sup>

2.10

**New**



6575M : E24, E26, E28, E30, E32

**6405PPD1** 3/4"

5  
PC.

£120.15<sup>B</sup>

2.19

# IMPACT SOCKET SETS

CHROME MOLYBDENUM



METRIC SIZE

At least **50%** above the DIN standards



IMPERIAL SIZE

At least **50%** above the ANSI standards



**4417MP**  $\frac{1}{2}$ " £91.67<sup>B</sup>  
198 x 108 x 32 mm  
Contents 4053 T25, T30, T40, T45, T50, T55, T60



**4457MP**  $\frac{1}{2}$ " £113.03<sup>B</sup>  
244 x 118 x 37 mm  
Contents 4065 H4, H5, H6, H8, H10, H12, H14



**4410MP**  $\frac{1}{2}$ " £55.18<sup>B</sup>  
246 x 103 x 38 mm  
Contents 4435M 12, 13, 14, 17, 19, 21, 22, 23



**4408MP**  $\frac{1}{2}$ " £36.49<sup>B</sup>  
270 x 73 x 46 mm  
Contents 4535M 10, 12, 13, 14, 17, 19, 21, 24



**4418MP**  $\frac{1}{2}$ " £92.56<sup>B</sup>  
198 x 105 x 32 mm  
Contents 4055 5, 6, 8, 10, 12, 14, 17, 19



**4414MP**  $\frac{1}{2}$ " £55.18<sup>B</sup>  
270 x 100 x 49 mm  
**4414SP**  $\frac{1}{2}$ " £58.74<sup>B</sup>

Contents 4535M 10, 11, 12, 13, 14, 15, 16, 17, 18, 19, 21, 22, 24, 27  
4535S 3/8", 7/16", 1/2", 9/16", 5/8", 11/16", 3/4", 13/16", 7/8", 15/16", 1", 1-1/16", 1-1/8", 1-1/4"



**4415MP02**  $\frac{1}{2}$ " £109.47<sup>B</sup>  
445 x 135 x 50 mm  
**4415MP03**  $\frac{1}{2}$ " £107.69<sup>B</sup>

Contents 4435M 10, 11, 12, 13, 14, 15, 16, 17, 18, 19, 21, 24, 27, 30, 32  
4435M 10, 11, 12, 13, 14, 15, 16, 17, 19, 21, 22, 24, 27, 30, 32



**4422MP01**  $\frac{1}{2}$ " £132.61<sup>B</sup>  
440 x 160 x 145 mm  
Contents 4535M 8, 9, 10, 11, 12, 13, 14, 16, 17, 18, 19, 21, 22, 23, 24, 27, 30, 32  
4797 426010 4866P 414710



**4427MP**  $\frac{1}{2}$ " £150.41<sup>B</sup>  
Contents 4535M 8, 9, 10, 11, 12, 13, 14, 15, 16, 17, 18, 19, 20, 21, 22, 23, 24, 25, 26, 27, 28, 29, 30, 32, 33, 34, 36

**4827MP**  $\frac{1}{2}$ " £168.21<sup>B</sup>  
Contents 4530M 8, 9, 10, 11, 12, 13, 14, 15, 16, 17, 18, 19, 20, 21, 22, 23, 24, 25, 26, 27, 28, 29, 30, 32, 33, 34, 36



INTERNAL **7K09MP**  $\frac{1}{2}$ " +  $\frac{3}{4}$ " £372.91<sup>B</sup>

**1/2" & 3/4" IMPACT SOCKET SET**  
Thin wall. For loosening and tightening KM nuts of DIN 981 ball bearings. To be used with extensions, ratchets etc. Application: Removal and installation of bearings, gear wheels, cone roll bearings, ball bearings etc. Trucks, landscaping, forestry and construction machines, etc.



EXTERNAL **7K09MP01**  $\frac{1}{2}$ " +  $\frac{3}{4}$ " £310.61<sup>B</sup>

Contents  
7K09MP 1/2" 44K8 TMFS 4, TMFS 5, TMFS 6, TMFS 7, TMFS 8  
3/4" 64K8 TMFS 9, TMFS 10, TMFS 11, TMFS 12  
7K09MP01 1/2" 44K7 TMFS 4, TMFS 5, TMFS 6, TMFS 7, TMFS 8  
3/4" 64K7 TMFS 9, TMFS 10, TMFS 11, TMFS 12



THINK ABOUT IT!

**786P06**

£35.60 <sup>B</sup>

**1/4" + 3/8" + 1/2" + 3/4" DR. IMPACT ADAPTER SET**

Contents

1/4" → → 3/8"  
2863P

3/8" → → 1/2"  
3864P

3/8" → → 1/4"  
3862P  
62 Nm max torque

1/2" → → 3/8"  
4863P  
202 Nm max torque

1/2" → → 3/4"  
4866P

3/4" → → 1/2"  
6864P  
512 Nm max torque



6 PC.

1.31



8 PC.

90 mm

**6458MP**

3/4"

£137.95 <sup>B</sup>

241 x 124 x 68 mm

Contents

3.9

6435M 24, 27, 29, 30, 32, 33, 36, 38



8 PC.

241 x 124 x 68 mm

**6408MP10**

3/4"

£92.56 <sup>B</sup>

**6408SP10**

3/4"

£105.02 <sup>B</sup>

Contents

3.5

**6408MP10**

6515M 19, 22, 24, 27, 30

6535M 32, 36, 38

**6408SP10**

6535S 3/4", 7/8", 15/16", 1-1/16", 1-3/16", 1-1/4", 1-7/16", 1-1/2"



8 PC.

445 x 100 x 65 mm

**6409MP03**

3/4"

£123.71 <sup>B</sup>

**6409SP**

3/4"

£118.37 <sup>B</sup>

Contents

4.6

**6409MP03**

6535M 21, 22, 24, 27, 30, 32, 36, 41

**6409SP**

6535S 1", 1-1/16", 1-1/8", 1-1/4", 1-5/16", 1-3/8", 1-7/16", 1-1/2"



14 PC.

422 x 372 x 92 mm

**6414MP**

3/4"

£267 <sup>B</sup>

Contents

11.94

6435M 19, 21, 22, 24, 26, 27, 29, 30, 32, 33, 35, 36, 38, 41

90 mm



14 PC.

422 x 372 x 92 mm

**6424MP**

3/4"

£310.61 <sup>B</sup>

Contents

11.58

6535M 24, 27, 30, 32, 33, 34, 36, 38, 41, 46, 50, 55, 60, 65



8 PC.

**8410MP**

1"

£141.51 <sup>B</sup>

280 x 130 x 74 mm

Contents

6.4

8535M 24, 27, 30, 32, 33, 36, 38, 41



8 PC.

80 mm

**8408MP10**

1"

£137.95 <sup>B</sup>

445 x 120 x 68 mm

Contents

6.9

8835M 24, 27, 30, 32, 33, 36, 38, 41



19 PC.

**6420MP01**

3/4"

£262.55 <sup>B</sup>

440 x 160 x 145 mm

Contents

12.8

6535M 19, 21, 22, 23, 24, 26, 27, 28, 29, 30, 32, 33, 34, 35, 36, 38, 41

6797 626010

# PNEUMATIC TOOLS

2 YEARS WARRANTY



108 Nm

37423080



£168.21<sup>B</sup>



881 Nm

33411050



£221.61<sup>B</sup>



1 2 3  
speed regulator

Forward / Reverse



678 Nm

33431050



£186.01<sup>B</sup>



1288 Nm

33481095



£283.91<sup>B</sup>



1491 Nm

33681100



£346.21<sup>B</sup>



2712 Nm

33862200



£841.05<sup>B</sup>



	Square drive	Anvil	Bolt size	Free speed	Max torque	Total length	Air inlet	Air hose	Air pressure	Air consumption	Noise	Vibrations	Weight
	Inch	Std. / Long	mm	R.P.M	Nm	mm	Inch	ID	bar	L/min	DBA	M/S <sup>2</sup>	kg
37423080	1/2"	Std.	M10	280	108	280	1/4"	3/8"	6.2	113	93	2.07	1.25
33411050	1/2"	Std.	M19	8000	881	194	1/4"	3/8"	6.2	125	96.5	8.13	2.80
33431050	1/2"	Std.	M16	9000	678	109	1/4"	3/8"	6.2	142	101.02	8.70	1.35
33461100	1/2"	Std.	M24	9500	1356	190	1/4"	3/8"	6.3	207	99.2	13.32	2.30
33481095	1/2"	Std.	M24	8000	1288	197	1/4"	3/8"	6.2	190	96	8.10	2.25
33681100	3/4"	Std.	M30	8000	1491	211	1/4"	3/8"	6.2	190	96	8.98	2.35
33862200	1"	Long	M36	5000	2712	487	1/2"	3/4"	6.2	255	104	14.5	8.10



CHROME MOLYBDENUM

At least 50% above the DIN and ANSI standards

15 PC.



1356 Nm

44803AMP01 1/2" £273.23<sup>B</sup>

Contents		5.7	
	4535M	17, 18, 19, 21, 22, 24, 27	 33461100 (1356 Nm)
	4435M	17, 19, 21	
	SY251M (1/4" BSPT)		
	426005P		
	4799P		
			LUBE15



7 PC.

7990A0 £51.62<sup>B</sup>

**INTERCHANGEABLE AIR BLOW GUN SET**

6 pcs quick release nozzle tip.  
 Plastic case dimensions : 207 x 170 x 55 mm.  
 6-angle adjustable airflow direction.  
 Quick release.  
 Airflow adjusting knob.  
 Brass inlet.  
 Air Pressure (bar) : 6.2 ~ 8.2  
 Air Pressure (PSI) : 90-120  
 Temperature range (°C) : -20°C ~ 85°C

Contents		0.5	
	7990AP02	 7990A0P01	
	7990AP03		
	7990AP04		
	7990AP05		
	7990AP06		
	7990AP07		

**CLEANING**

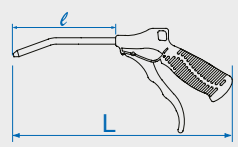
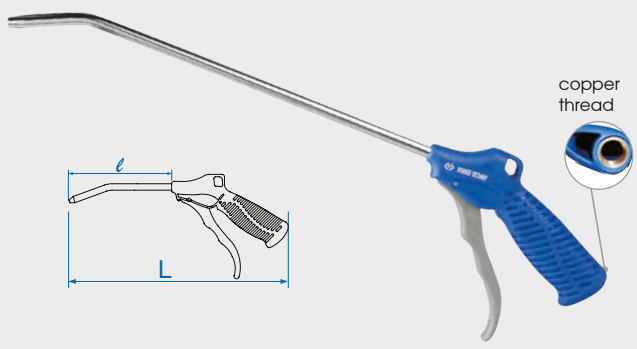

copper thread



7998206  
 Steel tank  
 Aluminum lance  
 Brass nozzle  
 Steel trigger  
 Aluminum alloy handle



7998210  
 Aluminum alloy tank  
 Steel lance  
 Aluminum alloy nozzle  
 Nylon trigger  
 Aluminum alloy handle

7990

**PNEUMATIC BLOW GUNS**

Steel nozzle. Nylon fiber handle.

	Nozzle length mm	Total length mm	Air inlet Inch	Air pressure bar	Air consumption L/min	Noise DBA	Weight g	
7990004	100	245	1/4"	6.2	350	85	200	£6.76 <sup>B</sup>
7990010	250	420	1/4"	6.2	350	85	240	£8.90 <sup>B</sup>
7990013	330	475	1/4"	6.2	350	85	260	£9.79 <sup>B</sup>
7990020	500	650	1/4"	6.2	350	85	300	£11.57 <sup>B</sup>

7998

**PNEUMATIC SPRAY GUNS**

Suitable for spraying a wide range of oils, cleaners and anti-rust liquids. Equipped with a fluid / air regulating valve.

	Capacity cc.	Working pressure bar	Working pressure psi	Air inlet Inch	Weight g	
7998206	600	6.2 - 10.3	90 - 150	1/4"	600	£22.25 <sup>B</sup>
7998210	1000	6.2 - 10.3	90 - 150	1/4"	800	£33.82 <sup>B</sup>

# COMBINATION WRENCHES

## WITHOUT RATCHET



### 1062 I-beam

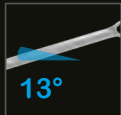
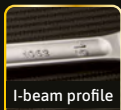

<p><b>12D12MRS</b> £56.96<sup>B</sup></p> <p>Contents: 8, 9, 10, 11, 12, 13, 14, 16, 17, 18, 19, 22</p> <p>Weight: 1.41</p>	<p><b>12D06MRS01</b> £30.26<sup>B</sup></p> <p>Contents: 10, 11, 13, 14, 17, 19</p> <p>Weight: 0.82</p>	<p><b>12D21MRN</b> £154.86<sup>B</sup></p> <p>Contents: 6, 7, 8, 9, 10, 11, 12, 13, 14, 15, 16, 17, 18, 19, 20, 21, 22, 24, 27, 30, 32</p> <p>Weight: 4.1</p>
<p><b>12D09MRN</b> £40.05<sup>B</sup></p> <p>Contents: 8, 9, 10, 11, 12, 13, 14, 17, 19</p> <p>Weight: 0.80</p>	<p><b>12D15MRN01</b> £78.32<sup>B</sup></p> <p>Contents: 8, 10, 11, 12, 13, 14, 15, 16, 17, 18, 19, 21, 22, 24</p> <p>Weight: 1.96</p>	<p><b>12D15MRN</b> £110.36<sup>B</sup></p> <p>Contents: 10, 11, 12, 13, 14, 15, 16, 17, 19, 21, 22, 24, 27, 30, 32</p> <p>Weight: 3.32</p>
<p><b>12D26MRN</b> £190.46<sup>B</sup></p> <p>Contents: 6, 7, 8, 9, 10, 11, 12, 13, 14, 15, 16, 17, 18, 19, 20, 21, 22, 23, 24, 25, 26, 27, 28, 29, 30, 32</p> <p>Weight: 5.6</p>		

**1061 I-beam**  
+10%  
13 PC.  
13°

**12A3MRN**  
£95.23<sup>B</sup>

Contents: 8, 10, 11, 12, 13, 14, 15, 16, 17, 18, 19, 22, 24

Weight: 2.16

13 PC.

**12B4MRN**  
£242.08<sup>B</sup>

Contents: 6, 8, 10, 11, 12, 13, 14, 15, 16, 17, 18, 19, 20, 21, 22, 23, 24, 25, 26, 27, 28, 29, 30, 32

Weight: 7

24 PC.

**1296MRN**  
£203.81<sup>B</sup>

Contents: 1071, 34, 36, 38, 41, 46, 50

Weight: 8.4

HEAVY DUTY RANGE.

15°

WITH REVERSIBLE RATCHET



15 PC.

**1275MRN** £119.26<sup>B</sup>

Contents  3.18

1067 6, 7, 8, 10, 11, 12, 13, 14, 17, 19, 22, 24, 27, 30, 32



14 PC.

**1214SRN01** £107.69<sup>B</sup>

Contents  3.54

5060 3/8", 7/16", 1/2", 9/16", 5/8", 11/16", 3/4", 13/16", 7/8", 15/16", 1", 1-1/16", 1-1/8", 1-1/4"



11 PC.

**1211SR** £55.18<sup>B</sup>

Contents  1.4

5060 1/4", 5/16", 3/8", 7/16", 1/2", 9/16", 11/16", 3/4", 13/16", 7/8", 15/16"

CHECK OUT THE COMPLETE COMBINATION WRENCHES RANGE!



**373AM** 

**Anti-slip ring**

- ✓ With its anti-slip ring, it will not slip off the fastener head.
- ✓ You'll work faster, and increase productivity and safety

Reversible  13°  15°



**122A07MRN01** £114.81<sup>B</sup>

Contents  0.91

373AM 8, 10, 11, 12, 13, 17, 19

**122A12MRN** £221.61<sup>B</sup>

Contents  2.06

373AM 8, 9, 10, 11, 12, 13, 14, 15, 17, 19, 22, 24

**122A14MRN** £248.31<sup>B</sup>

Contents  2.50

373AM 8, 9, 10, 11, 12, 13, 14, 15, 16, 17, 18, 19, 22, 24

**New** 

**24 → 32**

**122A04MRN** £200.25<sup>B</sup>

Contents  3.29

373AM 24, 27, 30, 32

4 PC.



10 PC.

**12210SR** £132.61<sup>B</sup>

Contents  1.8

3732S 5/16", 3/8", 7/16", 1/2", 9/16", 5/8", 11/16", 3/4", 7/8", 15/16"

Reversible  15°



12 PC.



Easy to recognize



Quick storage

**122A12MRS03** £186.01<sup>B</sup>

Contents  1.73

373AM 8, 9, 10, 11, 12, 13, 14, 16, 17, 18, 19, 22







13 PC.

**132A13MR** £175.33<sup>B</sup>

Contents  1.64

373AM 8, 10, 12, 13, 14, 16, 17, 18, 19

 1/4"  3/8"  1/2"  1/4"



NON-REVERSIBLE RATCHET



**12112MRS02** £146.85<sup>B</sup>

Non-reversible ratchet.

Contents 1.6

3731M 8, 10, 11, 12, 13, 14, 15, 16, 17, 18, 19, 22



**12107MRN01** £81.88<sup>B</sup>

Non-reversible ratchet.

Contents 910

3731M 8, 10, 11, 12, 13, 17, 19



**12112MRN** £161.09<sup>B</sup>

Non-reversible ratchet.

Contents 1.95

3731M 8, 9, 10, 11, 12, 13, 14, 15, 17, 19, 22, 24

**12114MRN** £196.69<sup>B</sup>

Non-reversible ratchet.

Contents 2.50

3731M 8, 9, 10, 11, 12, 13, 14, 15, 16, 17, 18, 19, 22, 24

NON-REVERSIBLE RATCHET & FLEXIBLE HEAD



**12007MRN** £111.25<sup>B</sup>

Flexible head. Non-reversible ratchet.

Contents 930

3730M 8, 10, 12, 13, 14, 17, 19



**13013MRE** £181.56<sup>B</sup>

Flexible head. Non-reversible ratchet.

Contents 2.12

3730M 8, 10, 12, 13, 14, 16, 17, 18, 19

1/4" 3/8" 1/2" 1/4"



**13012MRS01** £193.13<sup>B</sup>

Easy to recognize Quick storage

Contents 1.73

3730M 8, 9, 10, 11, 12, 13, 14, 16, 17, 18, 19, 22

SPEED WRENCH IN THE OPEN-END

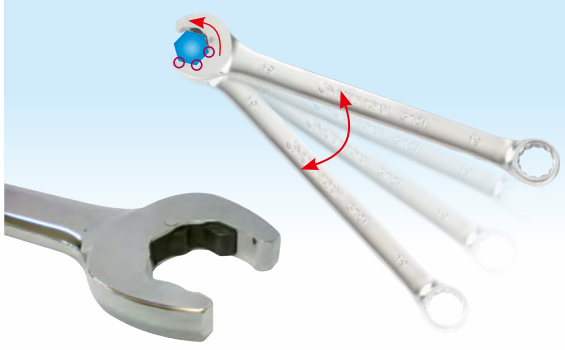

OPEN-SIDE SPEED

**14108SR** £90.78<sup>B</sup>

Contents 1.5

3721S 5/16", 3/8", 7/16", 1/2", 9/16", 5/8", 11/16", 3/4"

# RING WRENCHES

## WITH RATCHET



**14902MR01** £46.28<sup>B</sup>

Contents 0.37  
 8 x 10 x 12 x 13, 3739NM 16 x 17 x 18 x 19

2 PC.

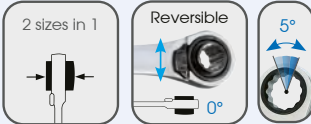

**14903MR01** £72.98<sup>B</sup>

Contents 0.51  
 8 x 9 x 10 x 11, 12 x 13 x 14 x 15, 16 x 17 x 18 x 19

3 PC.



16 PC.

Non-reversible 0.34

**1014CQ** £24.92<sup>B</sup>

Contents

3736M	10x13	
1025Z	1, 2, 3	1/4"
1025H	3, 4, 5, 6	5/16"
1025U	T10, T15, T20, T25, T30, T40	



**3737M**

Check out the full 3737M serie

6 24 mm

	mm	L mm	g	£
37370809M	8x9	128	45	£22.25 <sup>B</sup>
37371415M	14x15	190	130	£24.92 <sup>B</sup>
37372123M	21x23	260	408	£43.61 <sup>B</sup>



**3737MS** £239.41<sup>B</sup>

Contents 1.63  
 3737M 6x7, 8x9, 10x11, 12x13, 14x15, 16x18, 17x19, 21x23, 22x24

## WITHOUT RATCHET



**1C08MR** £59.63<sup>B</sup>

Contents 0.88  
 19C0 6x7, 8x9, 10x11, 12x13, 14x15, 16x17, 18x19, 20x22

8 PC.

**1C12MR** £126.38<sup>B</sup>

Contents 2.4  
 19C0 6x7, 8x9, 10x11, 12x13, 14x15, 16x17, 18x19, 20x22, 21x23, 24x26, 25x28, 30x32

12 PC.



**10C0**

HEAVY DUTY RANGE.

To be used with extension tubes 11 series

24 65 mm

	mm	L mm	Applied tube	g	£
10C065	65	356	113086	3200	£86.33 <sup>B</sup>



**1708MR** £58.74<sup>B</sup>

Contents 1.43  
 1970 6 x 7, 8 x 9, 10 x 11, 12 x 13, 14 x 15, 16 x 17, 18 x 19, 21 x 23

8 PC.

75°



**1950**

	mm	L mm	g	£
19500810	8x10	137	40	£8.99 <sup>B</sup>
19501012	10x12	141	55	£9.61 <sup>B</sup>
19501113	11x13	166	93	£11.84 <sup>B</sup>
19501214	12x14	166	94	£11.84 <sup>B</sup>
19501315	13x15	190	126	£13.53 <sup>B</sup>
19501417	14x17	190	126	£14.95 <sup>B</sup>
19501618	16x18	220	156	£17.44 <sup>B</sup>
19501719	17x19	220	174	£17.53 <sup>B</sup>
19501922	19x22	256	255	£18.60 <sup>B</sup>



**1F06MRN** £104.13<sup>B</sup>

Contents 1.69  
 19B0 10 x 11, 12 x 14, 13 x 15, 16 x 18, 17 x 19, 22 x 24

6 PC.

75°



**1712MRN** £121.93<sup>B</sup>

Contents 3.32  
 1970 6 x 7, 8 x 9, 10 x 11, 12 x 13, 14 x 15, 16 x 17, 18 x 19, 20 x 22, 21 x 23, 24 x 26, 25 x 28, 30 x 32

12 PC.

75°



**1406PR** £57.85<sup>B</sup>

Contents 1.25  
 1920 E6xE8 - E7xE11 - E10xE12 - E14xE18 - E16xE22 - E20xE24

6 PC.

\* The guarantee is unlimited in time, excluding 1/4" screw bits.

Non-contractual photographs. Offer valid from 01/01/2026 to 31/12/2026. Recommended retail prices in pounds excl. taxes.



# OPEN-END WRENCHES



## 10FO

### SINGLE OPEN END WRENCH

Features: The open end is thicker for very high tightening torques. Chrome vanadium alloy steel. Finished with phosphate sunk. DIN 894.

	Size mm	L mm		
10F017P	17	178	107	£3.83 <sup>B</sup>
10F019P	19	178	107	£4.63 <sup>B</sup>
10F021P	21	203	161	£5.34 <sup>B</sup>
10F022P	22	203	161	£5.34 <sup>B</sup>
10F023P	23	220	203	£7.30 <sup>B</sup>
10F024P	24	220	203	£7.30 <sup>B</sup>
10F026P	26	240	290	£8.90 <sup>B</sup>
10F027P	27	240	290	£8.90 <sup>B</sup>
10F029P	29	267	341	£10.24 <sup>B</sup>
10F030P	30	272	335	£10.24 <sup>B</sup>
10F032P	32	285	410	£11.57 <sup>B</sup>
10F036P	36	317	556	£16.02 <sup>B</sup>
10F038P	38	320	740	£17.80 <sup>B</sup>
10F041P	41	340	875	£20.47 <sup>B</sup>
10F046P	46	395	1060	£26.70 <sup>B</sup>
10F050P	50	425	1402	£32.93 <sup>B</sup>
10F055P	55	425	1403	£37.38 <sup>B</sup>
10F060P	60	470	2544	£48.95 <sup>B</sup>
10F065P	65	470	2441	£56.07 <sup>B</sup>
10F070P	70	500	3457	£70.31 <sup>B</sup>
10F075P	75	500	3333	£77.43 <sup>B</sup>



## 1108MR £33.82<sup>B</sup>

Contents 0.91  
 1900 6 x 7, 8 x 9, 10 x 11, 12 x 13, 14 x 15, 16 x 17, 18 x 19, 20 x 22

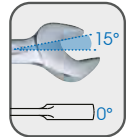

8 PC.



## 1112MRN £81.88<sup>B</sup>

Contents 2.35  
 1900 6 x 7, 8 x 9, 10 x 11, 12 x 13, 14 x 15, 16 x 17, 18 x 19, 20 x 22, 21 x 23, 24 x 27, 25 x 28, 30 x 32

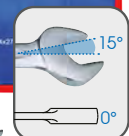

12 PC.

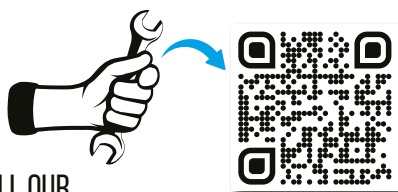

## ALL OUR OPEN-END WRENCHES



## 12DA06MRN £105.02<sup>B</sup>

**OPEN END WRENCH SLIGHT SET**  
 • Compact European model.  
 • Polished chrome finish.  
 • Short handle design (only 10 cm), ideal to work in restricted spaces, allowing a better handling and control.

Contents 1.44  
 1900 1062DA 22, 24, 27, 29, 30, 32



6 PC.

# FLARE NUT WRENCHES



## 1306MRN £54.29<sup>B</sup>

Contents 0.90  
 1930 8 x 10, 10 x 12, 11 x 13, 12 x 14, 17 x 19, 19 x 22

6 PC.

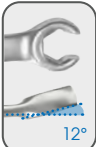

# ARTICULATED SOCKET WRENCHES



## 1A06MR £72.98<sup>B</sup>

Contents 1.32  
 1910 8 x 9, 10 x 11, 12 x 13, 14 x 15, 16 x 17, 18 x 19

6 PC.

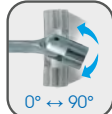

# ANGLED SOCKET WRENCHES



## 1826MR £335.53<sup>B</sup>

Contents 15  
 1080 6, 7, 8, 9, 10, 11, 12, 13, 14, 15, 16, 17, 18, 19, 20, 21, 22, 23, 24, 25, 26, 27, 28, 29, 30, 32

26 PC.



## 1812MR £103.24<sup>B</sup>

Contents 4.75  
 1080 8, 10, 11, 12, 13, 14, 16, 17, 18, 19, 22, 24

12 PC.

## 1916MR £129.05<sup>B</sup>

Contents 5.10  
 1081 8, 9, 10, 11, 12, 13, 14, 15, 16, 17, 18, 19, 21, 22, 23, 24

16 PC.

## 1926MR £325.74<sup>B</sup>

Contents 15  
 1081 6, 7, 8, 9, 10, 11, 12, 13, 14, 15, 16, 17, 18, 19, 20, 21, 22, 23, 24, 25, 26, 27, 28, 29, 30, 32

26 PC.

## 1912MR1 £105.91<sup>B</sup>

Contents   
 1081 8, 10, 11, 12, 13, 14, 16, 17, 18, 19, 22, 24

# ADJUSTABLE WRENCHES



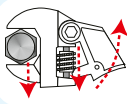

Speed take-up Jaw



One-millimetre graduation head



Comfortable handle

363110R

£43.61<sup>B</sup>

**METRIC ADJUSTABLE WRENCH**

470

361408R

2 IN 1

£36.49<sup>B</sup>

**REVERSIBLE JAW ADJUSTABLE WRENCH**

High depth capacity, thanks to its 30 % longer jaws than traditional adjustable wrenches. Super wide jaw opening, 50 % wider than regular adjustable wrenches. TPR handle with end hole.



Reversible jaw



Adjustable wrench function



Pipe wrench function



38 mm



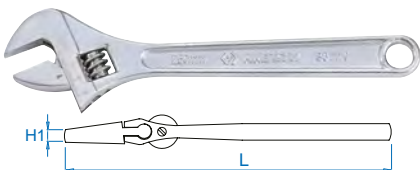



**36\_1\_R**

**ADJUSTABLE WRENCHES**

Millimeter graduation on the head. Chrome plated finish.

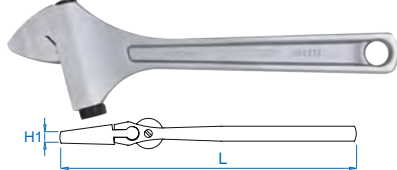

		H1 mm	L mm		
361106R	20	7	150	125	£10.68 <sup>B</sup>
361108R	25	8	200	226	£13.80 <sup>B</sup>
361110R	30	11	250	430	£17.80 <sup>B</sup>
362112HR	34	10	300	640	£15.84 <sup>B</sup>
362115HR	43	13	375	1485	£32.93 <sup>B</sup>
362118HR	52	18	460	1750	£56.07 <sup>B</sup>
362124HR	60	18.50	610	3140	£93.45 <sup>B</sup>



**3622R**

**ADJUSTABLE WRENCHES WITH LATERAL NUT**

No risk of jaws opening during use. Chrome plated finish.

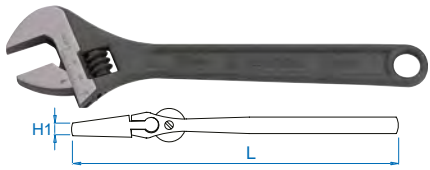

		H1 mm	L mm		
362210R	32.8	8.3	258.5	483	£32.93 <sup>B</sup>
362212R	38.1	9.6	308.5	786	£41.83 <sup>B</sup>
362216R	50	12.8	406.5	1677	£56.96 <sup>B</sup>
362220R	62	14.2	505.5	2634	£101.46 <sup>B</sup>



**3611P**

**ADJUSTABLE WRENCHES**

Millimeter graduation on the head. Phosphate finish.



		H1 mm	L mm		
361106P	20	7	150	125	£9.79 <sup>B</sup>
361108P	25	8	200	226	£12.91 <sup>B</sup>
361110P	30	11	250	430	£16.91 <sup>B</sup>
361112P	35	13	300	680	£21.36 <sup>B</sup>
361115HP	43	13	375	1485	£47.17 <sup>B</sup>
361118HP	53	18	450	1750	£72.98 <sup>B</sup>
361124HP	65	23	600	3343	£141.51 <sup>B</sup>

## SLOGGING WRENCHES



**RING SLOGGING WRENCH**

Chrome vanadium alloy steel. Finished with phosphate sunk. DIN 7444.

		L mm	D mm	H mm		
10B085	85	345	130	36	3710	£140.62 <sup>B</sup>
10B090	90	380	152	40	5850	£166.43 <sup>B</sup>
10B095	95	380	152	40	5350	£171.77 <sup>B</sup>
10B0A0	100	410	155	43	6445	£206.48 <sup>B</sup>
10B0A5	105	415	172	45	6500	£248.31 <sup>B</sup>
10B0B0	110	440	172	47	8000	£283.91 <sup>B</sup>
10B0B5	115	440	172	47	7500	£291.92 <sup>B</sup>
10B0C0	120	480	194	53	9000	£337.31 <sup>B</sup>



**OPEN END SLOGGING WRENCH**

Chrome vanadium alloy steel. Finished with phosphate sunk. DIN 133.

	Size mm	L mm	D mm	H mm		
10A080	80	395	175	33	6820	£179.78 <sup>B</sup>
10A085	85	395	175	33	6300	£183.34 <sup>B</sup>
10A090	90	440	197	38	9270	£229.62 <sup>B</sup>
10A095	95	440	197	38	8700	£249.20 <sup>B</sup>
10A0A0	100	480	230	45	10500	£297.26 <sup>B</sup>
10A0A5	105	480	230	45	10300	£305.27 <sup>B</sup>
10A0B0	110	505	238	47	14420	£337.31 <sup>B</sup>
10A0B5	115	505	250	53	14420	£399.61 <sup>B</sup>
10A0C0	120	530	258	53	15450	£425.42 <sup>B</sup>
10A0C5	125	530	258	56	15015	£437.88 <sup>B</sup>



# SELF-ADJUSTING WRENCH



466

361610

£36.49<sup>B</sup>

## SELF-LOCKING SPEED WRENCH

Self-locking function grip. Ideal for : 6 points, XZN®, square, Torx®, and even damaged screw heads. Capacity: 8-32 mm. Length: 265 mm.



3616S

## SELF-LOCKING SPEED WRENCH

Versatile, it adapts to all shapes of bolts and pipes. Non-slip teeth, effective on worn screws. Solid and durable: made of chrome-molybdenum (CrMo).



L  
mm



3616S08P

12 ~ 28

213

350

£44.50<sup>B</sup>

3616S14P

20 ~ 48

347

850

£63.19<sup>B</sup>



# HOOK WRENCHES



## HOOK WRENCHES

Articulated hook wrench for locknuts. 1 wrench replaces several sizes of wrenches. Can cover several capacities.



L  
mm



364135

13~35

174

96

£19.58<sup>B</sup>

364150

35~60

212

166

£24.03<sup>B</sup>

364180

50~80

285

352

£32.93<sup>B</sup>

3641C0

80~120

348

652

£45.39<sup>B</sup>

364110

120~180

480

1260

£61.41<sup>B</sup>

# WHEEL NUT WRENCHES



6 PC.

4506MR01

1/2"

£41.83<sup>B</sup>

## WHEEL NUT WRENCH SET WITH HANDLE AND 1/2" SOCKETS

Removable and ergonomic 1/2" handle. Quick use of the handle with the removable bar. Allows deep access.

Contents

1.56



265 mm



300 mm



17, 19, 21, 23

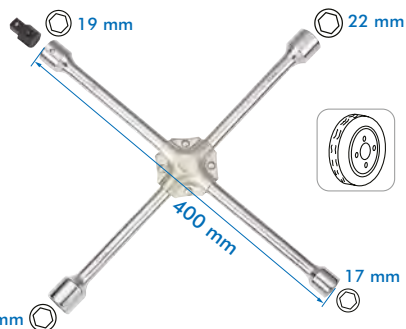

1.7

19911722

£28.48<sup>B</sup>

## 1/2" WHEEL NUT WRENCHES

For dismantling wheels. Chrome plated finish.

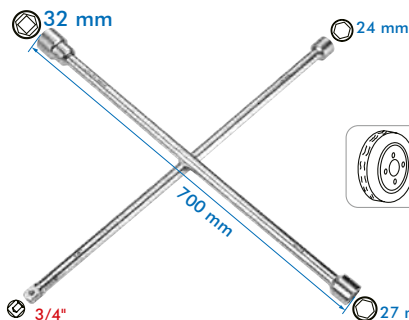

4.33

19932427

£69.42<sup>B</sup>

## 3/4" WHEEL NUT WRENCHES

For dismantling wheels. Chrome plated finish.

# PLIERS



Coarse serrated

**65117C**

£39.16<sup>B</sup>

## GROOVE JOINT PLIERS

DIN ISO 8976.

1.15

L mm	A mm	B mm	mm	Number of positions
425	58	55	100	7



Coarse serrated

**6517C**

## LOCKABLE TWIN GROOVE JOINT PLIERS

DIN ISO 8976. Serrated jaws lock on to pipes. Perfect grip on nuts.

L mm	A mm	B mm	mm	Number of positions	g	£	
651708C	200	54	44	40	16	190	£25.81 <sup>B</sup>
651710C	250	68	56	60	22	360	£28.48 <sup>B</sup>
651712C	310	89	73	70	26	540	£33.82 <sup>B</sup>



Smooth jaws

**651810C**

£42.72<sup>B</sup>

## PLIERS WRENCH

Smooth jaws to assemble plated fittings without damaging them. Suitable for gripping, holding, pressing and bending workpieces. Strong gripping power with 8x manual force transmission.

509



Ratchet function allowing to tighten or release bolts quickly and easily.



L mm	A mm	B mm	mm	Number of positions
266	35.5	57	42	17



**42124GP04**

£80.10<sup>B</sup>

Contents

1.5

623208	611108
631108	651710C



Cutting edges with bevel

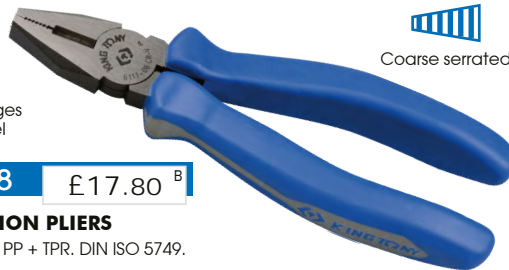

Coarse serrated

**611108**

£17.80<sup>B</sup>

## COMBINATION PLIERS

Grip material: PP + TPR. DIN ISO 5749.

L mm	Cutting Capacities (∅ mm)	g
213	<ul style="list-style-type: none"> <li>● 4.0 Soft wire</li> <li>● 3.0 Semi-soft wire</li> <li>● 2.0 Hard wire</li> <li>● 1.6 Piano wire</li> </ul>	340



Cutting edges with bevel



Heavy duty type

**611209**

£25.63<sup>B</sup>

## COMBINATION PLIERS

Pipe-grip. Grip material: PP + TPR. DIN ISO 5746.

L mm	Cutting Capacities (∅ mm)	g
225	<ul style="list-style-type: none"> <li>● 4.0 Soft wire</li> <li>● 3.0 Semi-soft wire</li> <li>● 2.2 Hard wire</li> <li>● 2.0 Piano wire</li> </ul>	389



Cutting edges with bevel



**621106** £14.24<sup>B</sup>

**DIAGONAL CUTTING PLIERS**

Grip material: PP + TPR. DIN ISO 5749.

L mm	Cutting Capacities (Ø mm)	kg
163	4.0 Soft wire	180
	2.8 Semi-soft wire	
	2.0 Hard wire	
	1.6 Plano wire	



Cutting edges with bevel



Heavy duty type

**623208** £16.91<sup>B</sup>

**DIAGONAL CUTTING PLIERS - HEAVY DUTY TYPE**

Grip material: PP + TPR. DIN ISO 5749.

L mm	Cutting Capacities (Ø mm)	kg
200	5.0 Soft wire	280
	3.5 Semi-soft wire	
	2.2 Hard wire	
	2.0 Plano wire	



Cutting edges with bevel

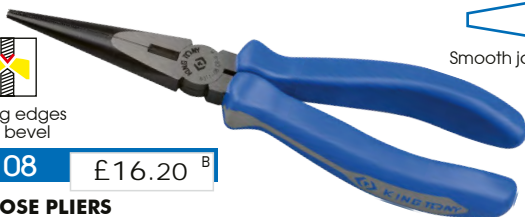

Smooth jaws

**631108** £16.20<sup>B</sup>

**LONG-NOSE PLIERS**

Grip material: PP + TPR. DIN ISO 5749.

L mm	Cutting Capacities (Ø mm)	kg
200	4.0 Soft wire	227
	3.0 Semi-soft wire	
	2.0 Hard wire	
	1.6 Plano wire	



Cutting edges with bevel

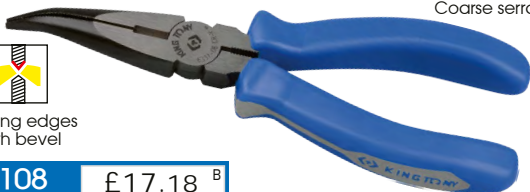

Coarse serrated

**633108** £17.18<sup>B</sup>

**BENT NOSE PLIERS**

Grip material: PP + TPR. DIN ISO 5745.

L mm	Cutting Capacities (Ø mm)	kg
200	4.0 Soft wire	218
	3.0 Semi-soft wire	
	2.0 Hard wire	
	1.6 Plano wire	



280 mm

**631911C** £16.91<sup>B</sup>

kg 317

**EXTRA LONG NOSE PLIERS**

Slim jaws design for gripping components in recessed areas.

Smooth jaws



**632913** £24.03<sup>B</sup>

**EXTRA LONG DOUBLE JOINTED LONG-NOSE PLIERS**

A mm	B mm	L mm	kg
50	110	340	365

Smooth jaws



**633913C** £23.32<sup>B</sup>

**ANGLED, EXTRA-LONG, DOUBLE-JOINT HALF-ROUND NOSE PLIERS**

A mm	B mm	L mm	kg
50	110	335	369

Smooth jaws

LIMITED QUANTITY



Reversible version



**6122X**

**REVERSIBLE AUTOMATIC TWISTING PLIERS**

Simple pull action twists wires into a tight uniform fastener. Ideal for twisting wires to secure assemblies subjected to vibration and other force.

L mm	Ø max wire to twist mm	kg
285	Ø 1.5	0.45

**612209X** £67.64<sup>B</sup>



Cutting edges with bevel

**641106** £15.13<sup>B</sup>

### END CUTTING PLIERS

Grip material: PP + TPR. DIN ISO 5748.

L mm	Cutting Capacities (Ø mm)			kg
163	4.0	Soft wire		240
	3.0	Semi-soft wire		
	1.6	Hard wire		
	1.6	Plano wire		



Cutting edges with bevel

**6431**

### HEAVY-DUTY END NIPPERS

Cutting edges with bevel. Grip material - PVC. DIN ISO 5748.

L mm	Cutting Capacities Ø mm			kg	Price	
	Soft wire	Semi-soft wire	Hard wire			
643110	254	3.0	2.0	1.6	445	£14.24 <sup>B</sup>
643111	278	3.0	2.2	1.8	510	£15.13 <sup>B</sup>

## RIVETING PLIERS



for  
Ø 3.2, 4, 4.8, 6.4 mm

**79711** £51.62<sup>B</sup>

### 2-ARM MANUAL RIVETING PLIERS

For Ø 3.2, 4, 4.8, 6.4 mm rivets.  
Cast aluminium body.  
Length: 460 mm.

kg 1.49



for  
M5, M6, M8, M10  
**6** PC.

**79731** £82.77<sup>B</sup>

### 2 ARM RIVETING PLIERS

4 stainless steel riveting nozzles.  
For stainless steel or aluminum rivets: M5, M6, M8 and M10.  
Cast aluminium body.  
Length: 472 mm.

kg 1.86



Center cut.

**613308** £43.61<sup>B</sup>

### COMPACT BOLT CUTTER

High frequency induction hardening.  
Grip material: PP + TPR. DIN ISO 5749.

L mm	Cutting Capacities (Ø mm)		kg
200	6.0	Soft wire	399
	5.0	Semi-soft wire	
	4.0	Hard wire	
	3.5	Plano wire	



Center cut.

**6131**

### BOLT CUTTERS

GS and TUV compliant.



L mm	Cutting Capacities Ø mm		kg	Price	
	HRC 15	HRC 35			
613112	300	5	4	0.76	£29.37 <sup>B</sup>
613114	350	7	5	1	£34.71 <sup>B</sup>
613118	450	8	6	1.51	£42.72 <sup>B</sup>
613124	600	10	8	2.35	£52.51 <sup>B</sup>
613130	750	13	10	3.75	£72.09 <sup>B</sup>
613136	900	16	11	5.50	£97.01 <sup>B</sup>
613142	1050	18	13	8.56	£128.16 <sup>B</sup>



for  
Ø 2.4, 3.2, 4, 4.8 mm

**2120101** £22.25<sup>B</sup>

### MANUAL RIVETING PLIERS

For rivets Ø 2.4, 3.2, 4, 4.8 mm.  
Cast aluminium body. 4 Nosepieces.  
Length: 260 mm.

kg 539



for  
M4, M5, M6, M8  
**85** PC.

**213010MR** £64.97<sup>B</sup>

### THREADED INSERT RIVET TOOL SET

Designed for fastening objects to thin metal.  
4 interchangeable mandrels (M4, M5, M6, M8). Iron nut rivet selection 80 pcs.  
Length: 270 mm.  
Dimensions of the thermoformed: 186 x 375 mm.

kg 1.3

# CIRCLIPS PLIERS



Available in February

**New**

**6 PC.**

**KING TONY**  
INTERNAL & EXTERNAL CIRCLIP PLIERS SET  
Ensemble pinces circlip  
Dispositivo para alicates de anillo interno e externo  
Juego de alicates para anillos internos y externos  
6 PIECES / PIECES / STÜCKE / PEÇAS / PIEZAS  
NO. 42156GP

**42156GP** £93.45<sup>B</sup>

Contents		Weight
66HS07	L 188 mm, Ø 19~60 mm	1.83
66HS10	L 247 mm, Ø 40~100 mm	
66HB07	L 175 mm, Ø 19~60 mm	
66SS07	L 188 mm, Ø 19~60 mm	
66SS10	L 247 mm, Ø 40~100 mm	
66SB07	L 175 mm, Ø 19~60 mm	

**4 PC.**

**KING TONY**  
INTERNAL & EXTERNAL CIRCLIP PLIERS SET  
Ensemble pinces circlip  
Dispositivo para alicates de anillo interno e externo  
Juego de alicates para anillos internos y externos  
4 PIECES / PIECES / STÜCKE / PEÇAS / PIEZAS  
NO. 42114GP

**42114GP** £59.63<sup>B</sup>

Contents		Weight
68HS07	L 180 mm, Ø 18~60 mm	0.62
68HB07	L 170 mm, Ø 18~60 mm	
68SS07	L 180 mm, Ø 18~60 mm	
68SB07	L 170 mm, Ø 18~60 mm	

**4 PC.**

**KING TONY**  
INTERNAL & EXTERNAL CIRCLIP PLIERS SET  
Ensemble pinces circlip  
Dispositivo para alicates de anillo interno e externo  
Juego de alicates para anillos internos y externos  
4 PIECES / PIECES / STÜCKE / PEÇAS / PIEZAS  
NO. 42154GP

**42154GP** £53.40<sup>B</sup>

Contents		Weight
66HS07	L 188 mm, Ø 19~60 mm	0.62
66HB07	L 175 mm, Ø 19~60 mm	
66SS07	L 188 mm, Ø 19~60 mm	
66SB07	L 175 mm, Ø 19~60 mm	



**11 PC.**

**KING TONY**  
INTERNAL & EXTERNAL CIRCLIP PLIERS SET  
Ensemble pinces circlip  
Dispositivo para alicates de anillo interno e externo  
Juego de alicates para anillos internos y externos  
11 PIECES / PIECES / STÜCKE / PEÇAS / PIEZAS  
NO. 45211PP

**45211PP** £177.11<sup>B</sup>

Interchangeable tips. Ratcheting locking action handles.

Contents		Weight
406 mm, Ø 82~175 mm		3.32
45° Ø 82~175 mm		
90° Ø 82~175 mm		
406 mm, Ø 82~165 mm		
45° Ø 82~165 mm		
90° Ø 82~165 mm		

**15 PC.**

**KING TONY**  
INTERNAL & EXTERNAL CIRCLIP PLIERS SET  
Ensemble pinces circlip  
Dispositivo para alicates de anillo interno e externo  
Juego de alicates para anillos internos y externos  
15 PIECES / PIECES / STÜCKE / PEÇAS / PIEZAS  
NO. 45115PP

**45115PP** £79.21<sup>B</sup>

Interchangeable tips. Ratcheting locking action handles.

Contents		Weight
L 267 mm, Ø 65~140 mm		1.3
15° Ø 65~140 mm		
45° Ø 65~140 mm		
90° Ø 65~140 mm		
L 267 mm, Ø 65~120 mm		
15° Ø 65~120 mm		
45° Ø 65~120 mm		
90° Ø 65~120 mm		

# LOCK-GRIP PLIERS

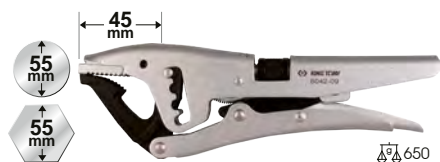

**604209** £51.62<sup>B</sup>

### LOCK GRIP PLIERS

620 daN max tightening.  
Length: 220 mm.  
Jaw width: 16 mm.  
Easy clamping and release with a single hand.  
4 positions.  
Chromed protection.  
Adjust clamping force with the wheel.

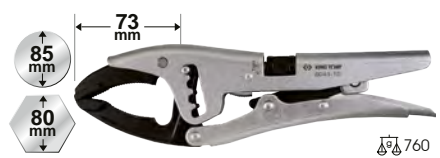

**604310** £45.39<sup>B</sup>

### LOCK GRIP PLIERS

310 daN max tightening.  
Length: 250 mm.  
Jaw width: 16 mm.  
Easy clamping and release with a single hand.  
4 positions.  
Chromed protection.  
Adjust clamping force with the wheel.



**604410** £57.85<sup>B</sup>

### LOCK GRIP PLIERS

320 daN max tightening.  
Length: 250 mm.  
Jaw width: 16 mm.  
Easy clamping and release with a single hand. 4 positions.  
Chromed protection.  
Adjust clamping force with the wheel.

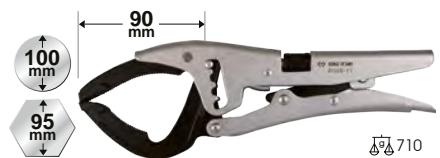

**604511** £65.86<sup>B</sup>

### LOCK GRIP PLIERS

290 daN max tightening.  
Length: 270 mm.  
Jaw width: 16 mm.  
Easy clamping and release with a single hand.  
4 positions. Chromed protection.  
Adjust clamping force with the wheel.

## 6011

### SINGLE-POINT LOCK GRIP PLIERS

Chrome molybdenum (CR-MO) steel handle.



	L mm	mm	mm		
601107	185	38	352	Nickel finish.	£14.06 <sup>B</sup>
601110	254	48	542	Nickel finish.	£16.91 <sup>B</sup>



**631509** £17.62<sup>B</sup>

### LONG NOSE PLIERS SINGLE-POINT

Thin and long jaw. Adjustable back screw. Integrated wire cutter. Ideal tool for hard-to-reach areas.

L mm	mm	mm
221	70	393



**665509** £27.59<sup>B</sup>

### CHAIN LOCK GRIP PLIERS

Adjustable back screw. Easy and fast to lock irregular forms.

L mm	mm	mm
225	Ø60 - 140	733



**40114GP** £74.76<sup>B</sup>

### LOCK GRIP PLIERS SET

Contents					
	60110R	Opening max 48		603110	Opening max 45
	631506	Opening max 51		661511	Opening max 100

# SCREWDRIVERS

## SCREWDRIVERS



Hanging hole



Round shank



7 PC.

SNCM + V

**30317PR** £28.48<sup>B</sup>

Contents 780

- ⊕ 1423 T10x75, T15x75, T20x100, T25x100, T27x100, T30x125, T40x150



9 PC.

SNCM + V

**30319PR** £34.71<sup>B</sup>

Contents 880

- ⊕ 1423 T8x75, T9x75, T10x75, T15x75, T20x100, T25x100, T27x100, T30x125, T40x150



7 PC.

SNCM + V

**30117MR** £27.59<sup>B</sup>

Contents 720

- ⊕ 1421 PH1x80, PH2x100
- ⊖ 1422 3x75, 4x100, 5.5x125, 6.5x150, 8x175



6 PC.

SNCM + V

**31116MR** £22.25<sup>B</sup>

Contents 560

- ⊕ 1421 PH0x60, PH1x80, PH2x100
- ⊖ 1422 3x75, 5.5x100, 6.5x150



### Ergonomic handle

- ★ Made of PP + TPR
- ★ Non-slip
- ★ Chemical and oil resistant

## GO-THROUGH SCREWDRIVERS



Go-through blade



Steel tipped handle for allowing light strikes



Hex-shank



6 PC.

SNCM + V

**30206MR** £41.83<sup>B</sup>

Contents 1.2

- ⊕ 1461 PH1x75, PH2x100, PH3x150
- ⊖ 1462 5.5x100, 6.5x150, 8x175

## ZOOM IN...

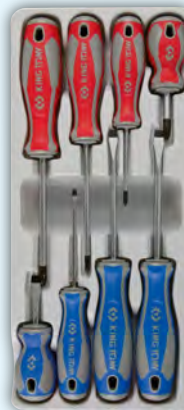

8 PC.

SNCM + V

**33108MR** £36.49<sup>B</sup>

Contents 1.3

- ⊕ 1421 PH0 x 60, PH1 x 100, PH2 x 100, PH2 x 38
- ⊖ 1422 3 x 75, 5.5 x 100, 6.5 x 38, 6.5 x 100

## STRAIGHT BLADES SCREWDRIVERS

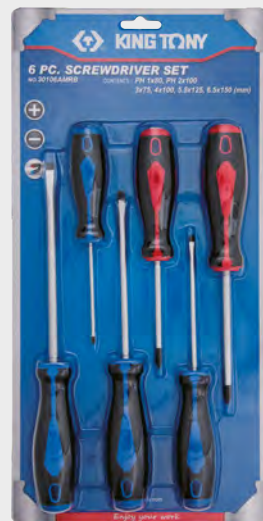

6 PC.

S2

Straight blade

**30106AMRB** £17.53<sup>B</sup>

Contents 560

- ⊕ 14A1 PH1 x 80, PH2 x 100
- ⊖ 14A2 3 x 75, 4 x 100, 5.5 x 152, 6.5 x 150

# ZOOM IN...



3 PC.

## 31003MR

£18.69<sup>B</sup>

Contents

1.384

⊕	1421	Extra-long	PH2 x 300
⊖	1422	Extra-long	6.5 x 300
		212118	565 mm



5 PC.

## 930505MR

£64.97<sup>B</sup>

### FLEXIBLE NUTSPINNER SET

Contents

0.68

○	1453	H5, H6, H7, H8, H10
---	------	---------------------



11 PC.

## 32518MR

£37.38<sup>B</sup>

### REVERSIBLE SCREWDRIVER SET

Blades length : 125 mm.

Contents

700

⊕	1317PN	PH1 x PH2
⊖	1317SN	4 x 6, 5 x 7
⊗	1317ZN	PZ1 x PZ2
⊙	1317TN	T10 x T15, T20 x T25, T30 x T40
●	1317BHN	B4 x H4 / B5 x H5 / B6 x H6
		91232



12 PC.

## 30112MR

£83.66<sup>B</sup>

Contents

1.3

○	1450	4, 4.5, 5, 5.5, 6, 7, 8, 9, 10, 11, 12, 13
---	------	--



0.25

## 76MBH

£5.61<sup>B</sup>

### COMPACT MAGNETIZER / DEMAGNETIZER

3-in-1: magnetizer, demagnetizer and storage stand.

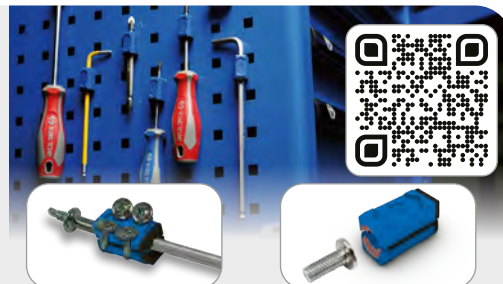

Backup screws can be magnetized to prevent losses.

The front-end is designed with a screw fixation groove to prevent screws from falling.

## Stop damaging your screwdrivers... Don't forget the pry bar !



4 PC.

## 9TK014

£51.62<sup>B</sup>

Contents

1.85

### PRY BAR SET

Minimises lever spring effect. Hardened and tempered steel. PP+TRP handle. Chrome vanadium. Thermoformed tray. 650x150x45 mm

	9TK108
	9TK112
	9TK118
	9TK124



4 PC.

## 9TK024

£221.61<sup>B</sup>

### PRY BAR SET

For heavy duty use. Includes a straight pry bar and 90°, 45° and 30° bent pry bars. Suitable for a wide range of uses. Extra long pry bars for more leverage.

Contents

9.34

	9TK225A,	90°
	9TK225B,	45°
	9TK236A,	30°
	9TK236B,	0°

**New**



3 PC.

## 9TK053

£84.55<sup>B</sup>

### SET OF PRY BAR WITH ARTICULATED HEAD

Used for removing, repositioning, or aligning components, especially in industrial applications. Its curved head allows easy access to hard-to-reach areas, enabling quick and effective leverage.

Contents

1.4

	9TK510D1	(254 mm)
	9TK512D1	(305 mm)
	9TK515D1	(381 mm)



4 PC.

## 9TK034

£52.51<sup>B</sup>

### PRY BAR SET

Lady foot rolling head pry bar. Curved end ensures better leverage in small areas. Tapered point end for alignment work.

Contents

1.73

	9TK320
	9TK316
	9TK312
	9TK306

# RATCHET SCREWDRIVERS

LIMITED QUANTITY

9 PC.



**32809MR** 1/4" £23.14 B

## ARTICULATED RATCHET SCREWDRIVER SET WITH BITS

Contents		300
⊖	1/4" 1025S 4, 5	
⊕	1/4" 1025P PH1, PH2, PH3	
⊗	1/4" 1025Z PZ1, PZ2	
	75060 2166DF	

55 PC.



**2555MR** 1/4" £63.19 B

## SET WITH ARTICULATED RATCHET SCREWDRIVER, 1/4" BITS AND SOCKETS

Articulated handle, ideal for confined and difficult to reach spaces

Contents		1
⊖	1/2" 2335M 4, 4.5, 5, 5.5, 6, 7, 8, 9, 10, 11, 12, 13, 14	
⊖	1/4" 1025S 3, 4, 4.5, 5, 5.5, 6, 6.5, 8	
⊕	1/4" 1025P PH0, PH1, PH2, PH3	
⊗	1/4" 1025Z PZ0, PZ1, PZ2, PZ3	
⊗	1/4" 1025U T10H, T15H, T20H, T25H, T27H, T30H, T40H	
⊗	1/4" 1025H H2, H2.5, H3, H4, H5, H6, H8	
⊗	1/4" 1025T T10, T15, T20, T25, T27, T30, T40	
⊗	1/4" 1025R RB1, RB2	
	770225 75060	
	2166DF	

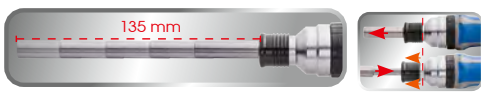

Extended magnetic bit holder



8 PC.



Forward, reverse and neutral

**32808MR** 1/4" £22.25 B

## 8 IN 1 RATCHET SCREWDRIVER SET

Contents		270
⊕	1/4" 1025P PH1, PH2	
⊗	1/4" 1025Z PZ2	
⊖	1/4" 1025S 4.0 x 0.5, 5.5 x 0.8, 6.5 x 1.2	
	215506	
	2155DF	

# RIGHT-ANGLE ADAPTER

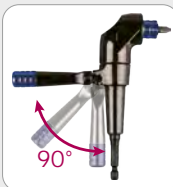

**759140** £37.38 B

## 1/4" RIGHT-ANGLE OFFSET DRIVER FOR SCREWDRIVER

For bits, dies and polisher pads. Magnetic bit holder. 24-position handle. 90° angle. For 18-24V screwdrivers. One screw bit can be stored in the handle. Length: 140 mm.



120 x 70 x 42 mm

**32540MR** 1/4" £43.61 B

Contents		580
⊖	1/4" 1025S 3.0, 4.0 (x2), 5.0, 5.5, 6.0, 6.5	
⊕	1/4" 1025P PH1 (x2), PH2 (x3), PH3	
⊗	1/4" 1025Z PZ1, PZ2 (x2), PZ2, PZ3	
⊗	1/4" 1025T T10, T15, T20, T25, T27, T30, T40	
⊗	1/4" 1025U T10H, T15H, T20H, T25H, T27H, T30H, T40H	
⊗	1/4" 1025H H3, H4, H5, H6	
	75363 770225	
	2155DF 215506	



\* The guarantee is unlimited in time, excluding 1/4" screw bits.

# IMPACT SCREWDRIVER

Rebellious screws and bolts?  
Try out the impact screwdriver!

The impact force releases rusted or frozen screws without damaging them. Handle with 2 non-slip knurled areas for a solid and secure grip. Practical, it can be used anywhere, since no external power source is required.



2 PC.

4116FR01

1/2" 3/4"

£54.29<sup>B</sup>

### IMPACT SCREWDRIVER SET

Maximum torque of the 1/2" sockets adapter: 512 Nm. Handle with tightening / loosening functions.

Contents		1.27
	4116 (3/4")	
		6814 (3/4" → 1/2")



10 PC.

4505MR

1/2" 5/16"

£42.72<sup>B</sup>

### IMPACT SCREWDRIVER SET

Contents		1.6
	5/16" 1836P PH2, PH3	
		5/16" 1836S 9, 11
	1/2" 4335M 8, 10, 12, 14	
	4112 (1/2")	
		4148 (1/2" → 5/16")

# BIT

LIMITED QUANTITY



10 PC.

1010MQ01

1/4"

£8.28<sup>B</sup>

Contents		710
	1/4" 7150S 6.5, 5.5, 4.5	
	1/4" 7100P PH1, PH2, PH3	
	1/4" 7100Z PZ1, PZ2, PZ3	
	1/4" 75060	



11 PC.

1011MQ

£21.09<sup>B</sup>

Contents		820
	10 mm (L: 36 mm) 1636M	M5, M6, M8, M10, M12
	10 mm (L: 80 mm) 1680M	M5, M6, M8, M10, M12
	1/2" 414810M	



43 PC.

1043CQ

£67.64<sup>B</sup>

Impact version.

Contents		2.42
	10 mm (L: 36 mm) 1636H	H4, H5, H6, H7, H8, H10, H12
	10 mm (L: 80 mm) 1680H	H4, H5, H6, H7, H8, H10, H12
	10 mm (L: 36 mm) 1636M	M5, M6, M8, M10, M12
	10 mm (L: 80 mm) 1680M	M5, M6, M8, M10, M12
	10 mm (L: 36 mm) 1636T	T20, T25, T27, T30, T40, T45, T50, T55, T60
	10 mm (L: 80 mm) 1680T	T20, T25, T27, T30, T40, T45, T50, T55, T60
	1/2" 414710M	

LIMITED QUANTITY

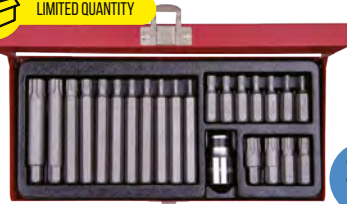

23 PC.

1023EQ

£39.16<sup>B</sup>

Contents		1.36
	10 mm (L: 36 mm) 1636E	10IP, 15IP, 20IP, 25IP, 27IP, 30IP, 40IP, 45IP, 50IP, 55IP, 60IP
	10 mm (L: 80 mm) 1680E	10IP, 15IP, 20IP, 25IP, 27IP, 30IP, 40IP, 45IP, 50IP, 55IP, 60IP
	1/2" 414810M	



\*The guarantee is unlimited in time, excluding 1/4" screw bits.





LIGHTWEIGHT,  
COMPACT  
PP CASE.



41  
PC.

**1041CQ02B** 10 mm £76.54<sup>B</sup>

**10 MM BIT SET**

Contents

2.1

	1636M	M5, M6, M8, M9, M10, M12, M14
	1636T	T10, T15, T20, T25, T27, T30, T40, T45, T50, T55, T60
	1636H	H5, H6, H8, H10
	1680M	M5, M6, M8, M9, M10, M12, M14
	1680T	T10, T15, T20, T25, T27, T30, T40, T45, T50, T55, T60
	414810M	



S2

6  
PC.

**1004A6HQ** £5.34<sup>B</sup>

Contents

90

	1/4"	7150H	H2, H2.5, H3, H4, H5, H6
--	------	-------	--------------------------



S2

6  
PC.

**1004A6TQ** £5.79<sup>B</sup>

Contents

90

	1/4"	7100T	T15, T20, T25, T27, T30, T40
--	------	-------	------------------------------

**1004D6TQ** £13.80<sup>B</sup>

Contents

200

	1/4"	7100T	T15, T20, T25, T27, T30, T40
--	------	-------	------------------------------



S2

32  
PC.

120 x 70 x 42 mm **1032CQ** 1/4" £24.92<sup>B</sup>

Contents

300

	1/4"	1025S	3, 4, 5, 6
	1/4"	1025P	PH1, PH2, PH2, PH3
	1/4"	1025Z	PZ1, PZ2, PZ2, PZ3
	1/4"	1025T	T10, T15, T20, T25, T27, T30, T40
	1/4"	1025U	T10H, T15H, T20H, T25H, T27H, T30H, T40H
	1/4"	1025H	H3, H4, H5, H6
		75363	770225



S2

49  
PC.

150 x 102 x 46 mm **1049CQ10** 1/4" £34.71<sup>B</sup>

Contents

510

	1/4"	1025P	PH1 x 2, PH2 x 2 ø6mm, PH2 x 2 ø4.7mm, PH3 x 2
	1/4"	1025S	4.0 x 2, 5.5 x 2, 6.5 x 2
	1/4"	1025Z	PZ1 x 2, PZ2 x 2, PZ3 x 2
	1/4"	1025T	T9, T10, T15, T20, T25, T27, T30, T40
	1/4"	1025H	H2, H2.5, H3, H4, H5, H6, H7, H8
	1/4"	1025U	T9H, T10H, T15H, T20H, T25H, T30H, T40H
	1/4"	1025R	RB1, RB2
	1/4"	2142	2142
	1/4"	770	770225
	1/4"	750A	75050A



S2

49  
PC.

150 x 102 x 46 mm **1048MR** 1/4" £52.51<sup>B</sup>

Contents

530

	1/4"	1025S	3 x 0.5, 4 x 0.5, 5 x 0.8, 6 x 1
	1/4"	1025P	PH1 x 2, PH2 x 2 ø6mm, PH3, PH2 ø4.7mm
	1/4"	1025T	T10, T15, T20 x 2, T25, T27, T30, T40
	1/4"	1025H	H3, H4, H5, H6
	1/4"	1025U	T10H, T15H, T20H x 2, T25H, T27H, T30H, T40H
	1/4"	1025Z	PZ2 x 2
	1/4"	7150T	T15, T20, T25
	1/4"	7150S	4.0 x 0.8, 6.0 x 1.0
	1/4"	7150H	H3, H4, H5, H6, H7, H8
	1/4"	7150P	PH2 x 2
	1/4"	7150Z	PZ2

75075

75363

2746

\* The guarantee is unlimited in time, excluding 1/4" screw bits.

LIFETIME GUARANTEE\*

**New**

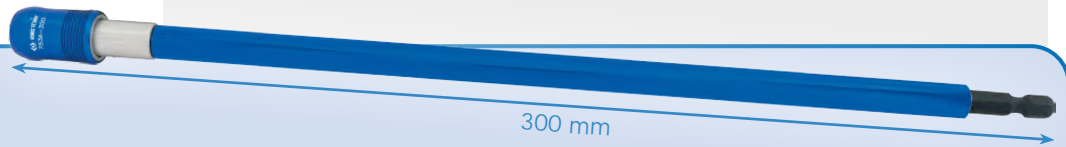

Magnetic anti drop design.



Automatic locking with one-touch.



One-click quick release.



Lightweight and durable aluminum alloy casing.

**753A300** 1/4" 300 mm

**1/4" QUICK-RELEASE MAGNETIC BIT HOLDER**

£17.80<sup>B</sup>

Chrome vanadium & stainless alloy steel. Anti-rust oiled, sand-blasted.

**Mini**

**ATOM Series**

140 x 65 x 36 mm

s2 **26 PC.**

**1026CQAM** 1/4" £45.39<sup>B</sup>

Contents  $\Delta$  390

	1/4"	1025H	H3, H4, H5, H6, H8
	1/4"	1025T	T10, T15, T20, T25, T27, T30, T40
	1/4"	1025Z	PZ1, PZ2, PZ3
	1/4"	1025P	PH1, PH2, PH3
	1/4"	1025U	T10H, T15H, T20H, T25H, T30H

276B35 75363 770225



**753B280D1** 1/4" 200 ~ 280 mm

**1/4" TELESCOPIC MAGNETIC BIT HOLDER**

£27.59<sup>B</sup>

The quick-release function improves work efficiency. Pull the locking ring forward to adjust the length.



**1010CMR** 1/4" £79.21<sup>B</sup>

**6 POINT DEEP BIT SOCKET SET**

Total length of 110 mm. Ideal for great depths. 63 mm deep socket to fit many bolts. Ideal for screwdrivers.

Contents

76C 8, 10, 12, 13, 14, 17, 19, 21, 23, 24

257 x 200 x 52 mm

10 PC. CHROME VANADIUM

**P2746** 1/4" £16.91<sup>B</sup>

Contents  $\Delta$  150

**LIMITED QUANTITY**

7 PC.

	1/4"	1025S	4.0 x 0.5, 5.5 x 0.8, 6.5 x 1.2
	1/4"	1025P	PH1, PH2
	1/4"	1025Z	PZ2

2746

**761M** 1/4"

	$\varnothing$ mm	L mm	$\Delta$	Price
7611008M	8	100	54	£3.65 <sup>B</sup>
7611010M	10	100	54	£3.65 <sup>B</sup>
7611012M	12	100	63	£3.65 <sup>B</sup>
7611013M	13	100	71	£3.65 <sup>B</sup>

**9103PR** 1/4" £7.12<sup>B</sup>

**SOCKET HOLDER SET WITH SAFETY BALL - 3 PCS**

Contents  $\Delta$  90

1/4"	770250
3/8"	770350
1/2"	770450

Security ball

3 PC.

Check out the full 761M serie

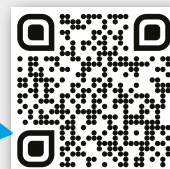

\* The guarantee is unlimited in time, excluding 1/4" screw bits. Non-contractual photographs. Offer valid from 01/01/2026 to 31/12/2026. Recommended retail prices in pounds excl. taxes.

# HEX KEY



**20210MR**  **10 PC.**

Contents  3.03

1125M H3, H4, H5, H6, H7, H8, H10, H12, H14, H17

£56.96<sup>B</sup>

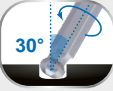

**201A09MR**  **9 PC.**

30° 

Ideal for hard-to-reach areas

Contents  450

1120A H1.5, H2, H2.5, H3, H4, H5, H6, H8, H10

£26.70<sup>B</sup>

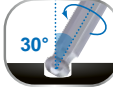

**20109MR**  **9 PC.**

30° 

Contents  450

1120MR H1.5, H2, H2.5, H3, H4, H5, H6, H8, H10

£18.69<sup>B</sup>



**201B09MR**  **9 PC.**

35° 

Contents  450

H1.5, H2, H2.5, H3, H4, H5, H6, H8, H10

£34.71<sup>B</sup>

**New**  **13 PC.**

**20113MW**  **£69.42<sup>B</sup>**

Contents  2.54

1130W H2, H2.5, H3, H4, H5, H6, H7, H8, H10, H12, H14, H17, H19

Magnetic tips from 3 to 19 mm

Dual-end design: hexagonal and ball-end for versatile applications

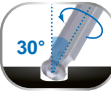

**20110MR**  **9 PC.**

30° 

Contents  390

1130M H1.5, H2, H2.5, H3, H4, H5, H6, H8, H10

£17.80<sup>B</sup>



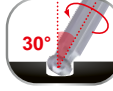

**20129SR**  **9 PC.**

30° 

Contents  390

1130S 1/16", 3/32", 1/8", 5/32", 3/16", 1/4", 5/16", 3/8", 5/64"

£16.91<sup>B</sup>

 **20109MW**  **9 PC.**

20° 

Contents  450

1120W H1.5, H2, H2.5, H3, H4, H5, H6, H8, H10

£21.36<sup>B</sup>

Color	mm	L mm
Light Blue	H1.5	92
Light Purple	H2	102
Light Blue	H2.5	115
Green	H3	129
Yellow	H4	144
Orange	H5	165
Red	H6	186
Purple	H8	208
Dark Blue	H10	234



**20505PR01**  **5 PC.**

Contents  330

1146M M5, M6, M8, M10, M12

£16.91<sup>B</sup>



**20515PR01**  **5 PC.**

Contents  630

1126M M5, M6, M8, M10, M12

£24.03<sup>B</sup>



9 PC.

SNCM + V

**20319PR**

£23.14<sup>B</sup>

Contents 500  
1123R T10, T15, T20, T25, T27, T30, T40, T45, T50



9 PC.

SNCM + V

**203A19PR**

£28.48<sup>B</sup>

Contents 450  
1123A T10, T15, T20, T25, T27, T30, T40, T45, T50

Length shortened by 33%



9 PC.

SNCM + V

**20419PR**

£24.03<sup>B</sup>

Contents 450  
1127R T10H, T15H, T20H, T25H, T27H, T30H, T40H, T45H, T50H



9 PC.

SNCM + V

**204B29PR**

£32.93<sup>B</sup>

Contents 370  
1137BR T10, T15, T20, T25, T27, T30, T40, T45, T50

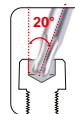

MATERIALS



DURABILITY

Cr-V

chrome vanadium steel alloy

S2

silicon chrome vanadium steel alloy

SNCM + V

nickel chromium molybdenum vanadium silicon steel alloy



8 PC.

SNCM + V

**22218MR**

£44.50<sup>B</sup>

Contents 1.1  
1165MR H2, H2.5, H3, H4, H5, H6, H8, H10



9 PC.

SNCM + V

**22319TR**

£49.84<sup>B</sup>

Contents 1.2  
1163TR T10, T15, T20, T25, T27, T30, T40, T45, T50



8 PC.

Cr-V

**24308PR**

£21.63<sup>B</sup>

Contents 270  
1163A T5, T6, T7, T8, T9, T10, T15, T20

SNCM + V

8 PC.

**23208MR**

£87.22<sup>B</sup>

Contents 1.64  
1195A H2, H2.5, H3, H4, H5, H6, H8, H10

FREE ARM ROTATION

Support to be placed or fixed to a wall

New

FREE ARM ROTATION

SNCM + V

9 PC.

**23339PR**

£93.45<sup>B</sup>

Contents 1.3  
1193AR T10, T15, T20, T25, T27, T30, T40, T45, T50

Support to be placed or fixed to a wall

# HAMMER



Please wear proper safety gear while working.



## 78210S

### ENGINEER HAMMER

Hickory wood handle. Steel head.  
DIN 1041.

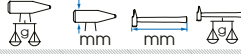

	Weight (kg)	Head width (mm)	Head length (mm)	Head height (mm)	Price (£)
782130OS	300	22.5	300	373	£9.79 <sup>B</sup>
782150OS	500	27	320	615	£14.24 <sup>B</sup>
782180OS	800	33	350	932	£18.69 <sup>B</sup>



## 78230S

### ENGINEER HAMMER

Hickory wood handle. Steel head.  
DIN 1193.

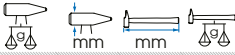

	Weight (kg)	Head width (mm)	Head length (mm)	Head height (mm)	Price (£)
782310OS	1000	36	360	1196	£20.65 <sup>B</sup>
782315OS	1500	41	380	1661	£27.59 <sup>B</sup>
782320OS	2000	46	400	2200	£35.60 <sup>B</sup>



## 7820

### ENGINEER HAMMER

Three-component handle. Steel head.

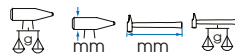

	Weight (kg)	Head width (mm)	Head length (mm)	Head height (mm)	Price (£)
782023	300	22.5	300	471	£21.36 <sup>B</sup>
782027	500	27	320	702	£26.70 <sup>B</sup>
782036	1000	36	360	1353	£37.38 <sup>B</sup>
782042	1500	41.5	360	1853	£41.83 <sup>B</sup>



## 7861

### CARPENTER'S HAMMER

Hickory wood handle. Steel head.  
DIN 1041.



	Weight (kg)	Head width (mm)	Head length (mm)	Head height (mm)	Price (£)
786116	450	30	335	740	£12.46 <sup>B</sup>
786120	565	31	340	830	£13.80 <sup>B</sup>
786124	680	32	380	920	£17.44 <sup>B</sup>



## 78220S

### RIVETING HAMMER

Ash curved handle. Steel head.  
DIN 1193.

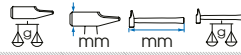

	Weight (kg)	Head width (mm)	Head length (mm)	Head height (mm)	Price (£)
782225OS	400	27	310	438	£10.50 <sup>B</sup>
782230OS	500	29	320	554	£12.28 <sup>B</sup>
782235OS	800	36	350	938	£16.82 <sup>B</sup>
782240OS	1000	38	360	1141	£18.69 <sup>B</sup>
782245OS	1500	45	380	1671	£26.70 <sup>B</sup>
782250OS	2000	50	400	2150	£31.15 <sup>B</sup>



## 7862

### RIVETING HAMMER

Three-component handle. Steel head.

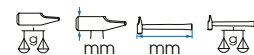

	Weight (kg)	Head width (mm)	Head length (mm)	Head height (mm)	Price (£)
786229	500	29	325	697	£26.08 <sup>B</sup>
786238	1000	38	360	1364	£36.49 <sup>B</sup>
786244	1500	44	365	1778	£42.72 <sup>B</sup>
786250	2000	50	405	2460	£56.07 <sup>B</sup>



## 78110S

### BALL PEEN ENGINEER'S HAMMER

Hickory wood handle. Steel head.  
C45, BA876.

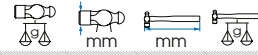

	Weight (kg)	Head width (mm)	Head length (mm)	Head height (mm)	Price (£)
781108OS	230	23	300	318	£10.68 <sup>B</sup>
781112OS	340	27	325	428	£12.46 <sup>B</sup>
781116OS	440	28	350	562	£13.80 <sup>B</sup>
781124OS	540	31	365	656	£16.73 <sup>B</sup>
781132OS	700	33	375	803	£19.58 <sup>B</sup>
781140OS	910	40	405	1100	£23.14 <sup>B</sup>



## 787125

£8.90<sup>B</sup>

### SOLDER CHIPPING HAMMER

Epoxy finish. Horizontal peen.  
Nylon handle.

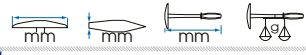

	Weight (kg)	Head width (mm)	Head length (mm)	Head height (mm)
787125	120	18	275	255



## 78330S

### BEVELLED EDGE CLUB HAMMER

Ash curved handle. Steel head.  
DIN 1193.



	Weight (kg)	Head width (mm)	Head length (mm)	Head height (mm)	Price (£)
783310OS	1000	40	260	1081	£15.22 <sup>B</sup>
783312OS	1250	43	260	1287	£17.80 <sup>B</sup>
783315OS	1500	45	280	1650	£22.25 <sup>B</sup>
783320OS	2000	50	300	2050	£27.59 <sup>B</sup>



## 7843

### BEVELLED EDGE CLUB HAMMER

Three-component handle. Steel head.

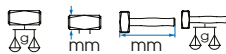

	Weight (kg)	Head width (mm)	Head length (mm)	Head height (mm)	Price (£)
784310	1000	39	260	1230	£31.15 <sup>B</sup>
784315	1500	45	280	1733	£39.16 <sup>B</sup>



## 7855



### BEVELLED EDGE CLUB HAMMER

Hickory wood handle. Head made of drawn copper rod with double hardening. Avoid flying sparks.

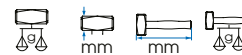

	Weight (kg)	Head width (mm)	Head length (mm)	Head height (mm)	Price (£)
785525	250	20	280	312	£26.70 <sup>B</sup>
785550	500	26	300	600	£44.50 <sup>B</sup>
785575	750	28	320	860	£60.52 <sup>B</sup>
785510	1000	33	350	1190	£79.21 <sup>B</sup>

# HAMMER WITH INTERCHANGEABLE TIPS

Find all the tips.  
22 50 mm



**915\_G**  
Rubber  
65/95 shore hardness

**915\_C**  
Cellulose  
100 shore hardness

**915\_N**  
Nylon  
100 shore hardness

**915\_P**  
Polyurethane  
92 shore hardness

Patented system,  
safety anchoring  
with double grip

Aluminium



## 7842\_PIH

### HAMMER WITH INTERCHANGEABLE TIPS

Hickory wood handle. Steel head.  
Polyurethane tips.

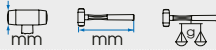

	mm	mm	mm	£
784222PIH	22	280	180	£14.77 <sup>B</sup>
784227PIH	27	300	294	£16.91 <sup>B</sup>
784232PIH	32	300	378	£20.47 <sup>B</sup>
784240PIH	40	320	624	£28.48 <sup>B</sup>
784250PIH	50	320	910	£36.49 <sup>B</sup>

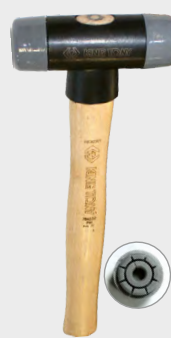

## 7842\_PAH

### HAMMER WITH INTERCHANGEABLE TIPS

Hickory wood handle. Aluminium head.  
Polyurethane tips.

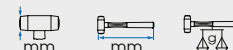

	mm	mm	mm	£
784222PAH	22	280	124	£11.57 <sup>B</sup>
784227PAH	27	300	187	£17.44 <sup>B</sup>
784232PAH	32	300	230	£21.36 <sup>B</sup>
784240PAH	40	320	375	£31.15 <sup>B</sup>
784250PAH	50	320	504	£42.72 <sup>B</sup>

Aluminium



## 7842\_PIT

### HAMMER WITH INTERCHANGEABLE TIPS

Three-component handle. Steel head.  
Polyurethane tips.

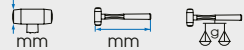

	mm	mm	mm	£
784227PIT	27	300	356	£26.70 <sup>B</sup>
784232PIT	32	300	450	£31.15 <sup>B</sup>
784240PIT	40	320	719	£44.50 <sup>B</sup>
784250PIT	50	320	975	£54.29 <sup>B</sup>



## 7842\_PAT

### HAMMER WITH INTERCHANGEABLE TIPS

Three-component handle. Aluminium head.  
Polyurethane tips.



	mm	mm	mm	£
784227PAT	27	300	259	£27.59 <sup>B</sup>
784232PAT	32	300	298	£33.82 <sup>B</sup>
784240PAT	40	320	459	£47.17 <sup>B</sup>
784250PAT	50	320	584	£62.30 <sup>B</sup>

## 7851

### DEAD BLOW HAMMERS

Polypropylene handle. Monobloc hammers with steel Micro-balls. Reduced quiver.



	mm	mm	mm	mm	£
785108	227	43	272	585	£11.84 <sup>B</sup>
785116	454	46	304	849	£14.51 <sup>B</sup>
785124	680	49	322	884	£16.55 <sup>B</sup>
785132	907	55	342	1090	£22.61 <sup>B</sup>
785140	1134	58	342	1218	£25.54 <sup>B</sup>
785148	1361	61	355	1511	£28.75 <sup>B</sup>
785164	1814	67	368	1874	£35.87 <sup>B</sup>



## 783450

### SLEDGE HAMMER

Glass fiber handle.



	mm	mm	mm	mm	£
783450	5000	68	908	5850	£57.85 <sup>B</sup>



## 7848

### RUBBER HAMMER

Ideal to lay basalt floors, tires and other material which cannot be damaged.

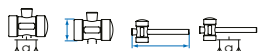

	mm	mm	mm	mm	£
784860	523	64	330	628	£11.57 <sup>B</sup>
784880	821	79	350	979	£15.13 <sup>B</sup>



## 7852

### DEAD BLOW RUBBER HAMMER

Fiberglass handle. Rubber head.

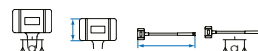

	mm	mm	mm	mm	£
785223	1650	69.5	500	2000	£77.43 <sup>B</sup>
785255	4500	104	910	5500	£148.63 <sup>B</sup>



# STRIKING TOOLS



Please wear proper safety gear while working.

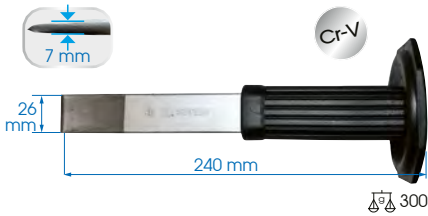

**7622610GR** £17.80<sup>B</sup>

### EXTRA-FLAT SHEATHED CHISEL

Reduced vibrations. Hand guard. Comfortable grip.

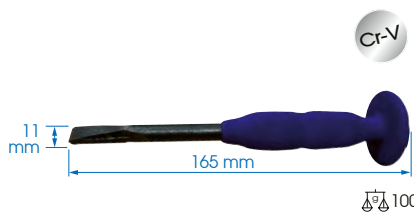

**7651007G** £9.79<sup>B</sup>

### SHEATHED CHISEL

Reduced vibrations. Hand guard. Comfortable grip.



**1005APR** £17.80<sup>B</sup>

Contents		320
	7610405	Ø 4 x 120
	7621505	15 x 125
	7630305	Ø 3 x 120
	7640406	Ø 4 x 150
	7650505	5 x 130



**76610**

### SHEATHED BRASS PIN PUNCH

Made from brass to protect the workpiece. Detachable handle: reduces vibrations and improves grip.

	L mm	Ø mm	300	Price
<b>7661010</b>	250	10	231	£15.75 <sup>B</sup>
<b>7661210</b>	250	12	382	£23.14 <sup>B</sup>
<b>7661510</b>	250	15	478	£27.59 <sup>B</sup>
<b>7662010</b>	250	20	637	£40.05 <sup>B</sup>



**1014GPL** £72.09<sup>B</sup>

Contents		1.78
	76612	Ø10, Ø12, Ø14, Ø16



**1014GPRB** £99.68<sup>B</sup>

Contents		1.7
	76610	Ø10, Ø12, Ø15, Ø20



**1025PRN** £29.37<sup>B</sup>

Contents		790
	762	13 x 100, 15 x 125, 17 x 150, 20 x 175, 23 x 200



## PIN PUNCHES

Non-slip and dampening notch on the handle allows to firmly grip and hold tools in place for a safer use.

Made of chrome-vanadium (Cr-V) steel. Brownish finish.



The dampening band inside the handle reduces choc wave on blade.



**76629P** £114.81<sup>B</sup>

### ANTI-VIBRATION ERGONOMIC HANDLE PIN PUNCH SET

Contents		2.67
	7661	10, 12, 14, 16, 18 x 290 mm



**76677P** £167.32<sup>B</sup>

### ANTI-VIBRATION ERGONOMIC SHEATHED PIN PUNCH AND CHISEL SET

Contents		3.316
	7661	10, 12, 14, 16, 18 x 290 mm
	762Bl	15 x 185 mm, 25 x 225 mm



### 1006PRN

£24.92<sup>B</sup>

Contents  570

764  $\varnothing 2 \times 30, \varnothing 3 \times 40, \varnothing 4 \times 50, \varnothing 5 \times 50,$   
 $\varnothing 6 \times 50, \varnothing 8 \times 50$

6  
PC.

### 1009PRN

£47.17<sup>B</sup>

Contents  1.6

764  $\varnothing 2 \times 30, \varnothing 3 \times 40, \varnothing 4 \times 50, \varnothing 5 \times 50,$   
 $\varnothing 6 \times 50, \varnothing 8 \times 50,$   
 $\varnothing 10 \times 65, \varnothing 12 \times 70, \varnothing 14 \times 75$

9  
PC.



### 1006GPN

£37.38<sup>B</sup>

Contents  800

764G  $\varnothing 2 \times 140, \varnothing 3 \times 150, \varnothing 4 \times 180,$   
 $\varnothing 5 \times 200, \varnothing 6 \times 210, \varnothing 8 \times 220$

6  
PC.

### 1009GPN

£72.09<sup>B</sup>

Contents  1.9

764G  $\varnothing 2 \times 140, \varnothing 3 \times 150, \varnothing 4 \times 180,$   
 $\varnothing 5 \times 200, \varnothing 6 \times 210, \varnothing 8 \times 220,$   
 $\varnothing 10 \times 230, \varnothing 12 \times 250, \varnothing 14 \times 290$

9  
PC.



7  
PC.

### 76625C

£48.95<sup>B</sup>

#### DEAD BLOW DRIFT SET

Body filled with micro-balls to absorb the shock and reduce vibrations. Protects workpieces during their positioning or extraction.

Contents  870

 160 mm Cr-V   $\varnothing 25$  mm brass

  $\varnothing 25$  mm polyamide   $\varnothing 25$  mm aluminium



LIMITED QUANTITY





9  
PC.



### 11409SQ

#### SET OF 9 NUMBER STAMPS

Numbers 0 to 9.

	L mm	 mm	 mm	
 11409SQ05	61	8x8	5	£11.57 <sup>B</sup>
 11409SQ08	71	12.7x12.7	8	£18.33 <sup>B</sup>
 11509SQ05	61	11x11	5	£16.29 <sup>B</sup>



LIMITED QUANTITY





27  
PC.



### 11427SQ

#### SET OF 27 LETTER STAMPS

A to Z with &.

	L mm	 mm	 mm	
 11427SQ05	61	8x8	5	£23.67 <sup>B</sup>
 11427SQ08	71	12.7x12.7	8	£54.29 <sup>B</sup>
 11527SQ05	71	11x11	5	£48.95 <sup>B</sup>

# PIPE TOOLS

## 6531

### STILLSON TYPE PIPE WRENCHES

Forged monobloc body and jaws. HRC 57 hardened serrated edge.



	inch	mm			
653110	34	10	229	600	£16.91 <sup>B</sup>
653112	42	12	270	780	£20.47 <sup>B</sup>
653114	48	14	312	1050	£22.25 <sup>B</sup>
653118	60	18	405	1720	£32.04 <sup>B</sup>
653124	75	24	541	3150	£49.84 <sup>B</sup>
653136	102	36	825	6280	£104.13 <sup>B</sup>
653148	140	48	1034	9750	£150.41 <sup>B</sup>



## 6533L

### Aluminum

### ALUMINUM PIPE WRENCH

40% lighter than the heavy-duty models. Easy spin adjusting nut. Heat-treated drop-forged jaws.



	inch	mm			
653310L	30	10	254	540	£22.25 <sup>B</sup>
653312L	40	12	300	833	£29.37 <sup>B</sup>
653314L	50	14	356	940	£32.93 <sup>B</sup>
653318L	60	18	455	1500	£51.62 <sup>B</sup>
653324L	75	24	600	2500	£77.43 <sup>B</sup>
653336L	85	36	910	5000	£150.41 <sup>B</sup>
653348L	110	48	1200	8000	£289.25 <sup>B</sup>



## 6521

### SWEDISH STYLE PIPE WRENCHES

For nuts, bolts, flat material. S shape jaws. Strong and reliable grip thanks to 3 tightening points. High quality forged steel body.

	inch	mm			
652116	38	16"	420	1450	£31.15 <sup>B</sup>
652121	51	21"	535	2404	£51.62 <sup>B</sup>

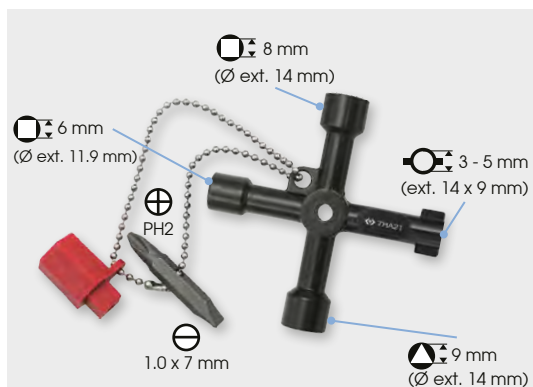

## 7HA21

£10.50<sup>B</sup>

### 4 WAY CONTROL CABINET KEY

For control cabinets and shut-off systems in the supply of gas, water and electricity. For technical installations in buildings, e.g. air conditioning and ventilation systems, shut-off valves, mains switch-boards, etc.



3 PC.

## 7HA03

£39.16<sup>B</sup>

### STAGED MOUNTING WRENCH

Designed to install and remove most of radiator valves and tank connectors. The 3/8", 11.6mm, 1/2", 3/4" and 1" hexagons built on the wrench's length allow to install different sizes of solenoid valves internal and internal pods.

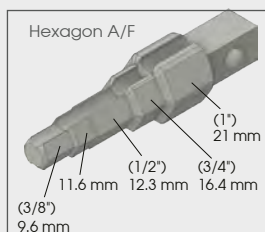

# PIPE CUTTER



**791221**



**791222**

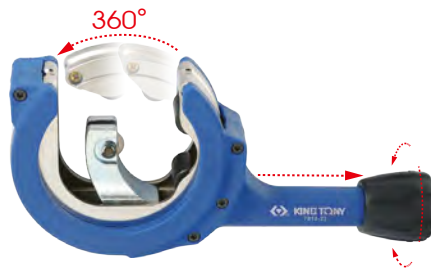

**791223**

## PIPE CUTTER RATCHET

Cuts without having to rotate the tool around the tube. Ideal for reduced spaces. Cut more resistant steel: stainless steel, copper and aluminum. Without reamer.

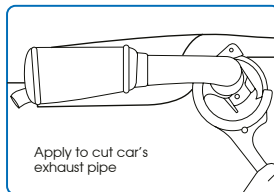

Apply to cut car's exhaust pipe



	Capacity ø mm	Max. cutting thickness (mm)		Weight kg	Price £
		Stainless	Other		
791221	8 ~ 28	2	3.0	389	£47.17 <sup>B</sup>
791222	12 ~ 35	2	3.0	452	£55.18 <sup>B</sup>
791223	28 ~ 67	2	3.0	1122.6	£129.94 <sup>B</sup>



10 PC.

**7CA0110S**

£65.86<sup>B</sup>

## AIR COOLING FLARING AND SLEEVE SET

Contents		Weight kg
791530	3-30 mm 1/8"-1-1/8"	1.40
7CA22P20S	3/16", 1/4", 5/16", 3/8", 7/16", 1/2", 5/8"	
7CA22P01		
Flare inserts	3/16", 1/4", 5/16", 3/8", 7/16", 1/2", 5/8"	

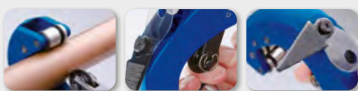
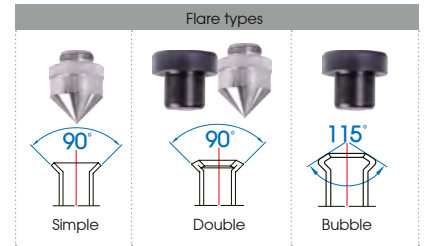

**7914A35**

£24.48<sup>B</sup>

Capacity ø mm	Max. cutting thickness (mm)	Length mm	Weight kg
3 ~ 35	1.2	140	333



Retractable deburring tool.

**7914C70**

£60.52<sup>B</sup>

Capacity ø mm	Max. cutting thickness (mm)	Length mm	Weight kg
6 ~ 70	1.2	222	802

## TUBE CUTTER

Ergonomic handle design for comfortable operation. Includes one piece spare cutting wheel. With four guide rollers. Full-stop feed system prevents wheels and rollers from coming into contact.



# PRECISION

## PRECISION SCREWDRIVERS



Precise screwing action thanks to the rotating section allowing effective pressure with the finger.

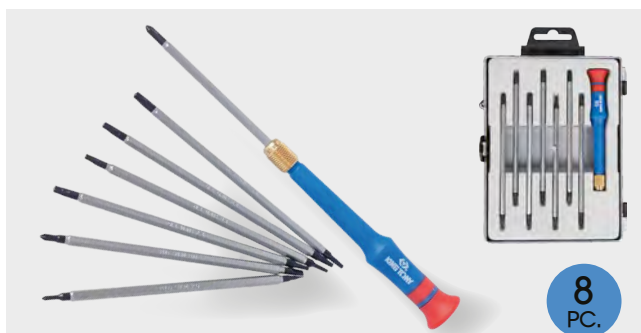

8 PC.

**32607MR**

£22.25<sup>B</sup>

### REVERSIBLE PRECISION SCREWDRIVERS

Contents

290

	91230		
	2431	PH00x2.0, PH0x3.0, PH1x4.0	
	2433	T6 x T10, T7 x T15, T8 x T20, T9 x T15	



9 PC.

**32309PR**

£26.70<sup>B</sup>

Contents

260

	1433	T4x40, T5x40, T6x40, T7x40, T8x40, T9x50, T10x50, T15x50, T20x50
--	------	--



8 PC.

**32108MR**

£22.25<sup>B</sup>

Contents

290

	1431	PH00x40, PH0x40, PH1x40
	1432	1.5x40, 2.0x40, 2.5x40, 3.0x40

## PRECISION PLIERS

7 PC.



**42207GP**

£91.67<sup>B</sup>

### PRECISION PLIERS SET

Contents

652

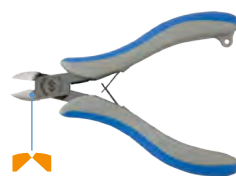

- Soft wire: ø2.0mm
- Semi-soft wire: ø1.6mm

**620705**

Diagonal Precision Cutting pliers

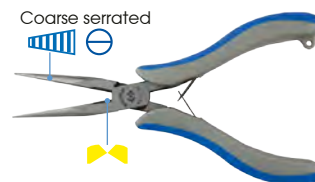

- Soft wire: ø2.0mm
- Semi-soft wire: ø1.6mm

**631706**

Precision pliers with half-round nose

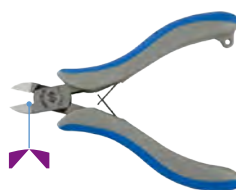

**692705**

Diagonal Precision Cutting Pliers, for plastic

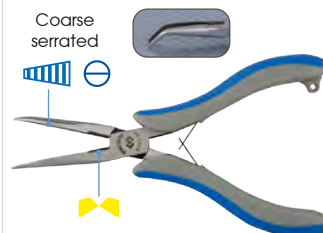

- Soft wire: ø2.0mm
- Semi-soft wire: ø1.6mm

**633706**

Precision pliers with half-round angled nose

Short flat nose

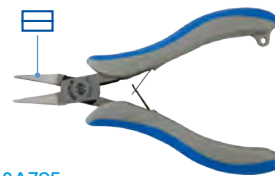

**63A705**

Short flat nose precision pliers



- Soft wire: ø1.0mm
- Semi-soft wire: ø0.5mm

**624705**

Diagonal Precision Cutting Pliers, For Components



**6AF11125**

Cross locking

# CUTTER

**794507** £12.10<sup>B</sup>

**DOUBLE BLADE FOLDING CUTTER**

LIMITED QUANTITY

Blade selection

trapezoidal blade

hook blade

171 mm

With belt clip

157.5

180 mm

Zinc alloy structure

1

2

Thread cutting notch

Non-slip TPR

1

2

Blade tank (2 blades included) Compatible with blades 794507P01

60 x 18 mm trapezoidal blade, made of SK5 carbon steel

Large button

High strength wheel lock

117

**797707** £6.68<sup>B</sup>

**UTILITY CUTTER**

Improved blade locking system.  
Blade material: SK4, HRC ≥ 65.  
Blade treatment: laser hardening technique ensuring great hardness of the cutting edge.  
Blade with black coating.  
Blade thickness: 0.7 mm.  
Length: 180 mm.

180 mm

**794607** £13.17<sup>B</sup>

**SELF-RETRACTING BLADE SAFETY CUTTER**

2 in 1: choose between the auto-retracting function (1) or locking the blade manually (2).

200

**797707P02** £4.18<sup>B</sup>

**SNAP-OFF BLADES**

Blade width: 18 mm.  
Blade material: SK4.  
For 797707 and 797807.  
Blade treatment: laser hardening technique ensuring great hardness of the cutting edge.

10 PC.

**797807P02** £3.12<sup>B</sup>

**SNAP-OFF BLADES**

Blade width: 18 mm.  
Blade material: SK4.  
For 797707 and 797807.

10 PC.

**KNIFE**

Release buckle

Blade fixator folded out

With belt clip

**794108A** £23.14<sup>B</sup>

**SAFETY CLASP KNIFE**

Light and handy to use.  
Stainless Blade with blacking coating.

210 mm

90 mm 120 mm

173

175 mm

135

**797807** £4.98<sup>B</sup>

**CUTTER WITH AUTOMATIC BLADE LOADER**

Automatically reloading snap-off blades.  
Blade material: SK4, HRC ≥ 62.  
Blade thickness: 0.5 mm.  
Blade width: 18 mm.

3-blade cartridge.

# SCISSORS

Stainless steel 420J2  
(HRC 52-55)

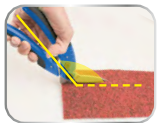
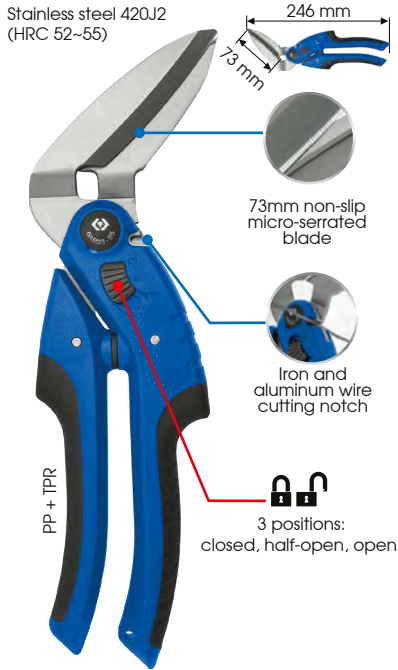

The wide angle between the handle and the blades allows the user's hand to never touch the material when cutting.

**6AB3395** £20.47<sup>B</sup>

## MULTIPURPOSE SCISSORS

Scissors designed for cutting soft materials such as tin foil, plastics, cardboard, paper, etc.

Cutting capacities:

- aluminum wire: 2.5mm
- copper wire: 2.5mm
- cardboard: 10mm
- carpet: 5mm
- copper: 0.5mm
- soft aluminum: 0.6mm



Stainless steel 4034  
(HRC 54-55)



**6AB1465** £30.26<sup>B</sup>

## MULTIFUNCTION ELECTRICIAN SCISSORS

All steel structure, durable and very strong.

Stainless steel 4034  
(HRC 54-55)

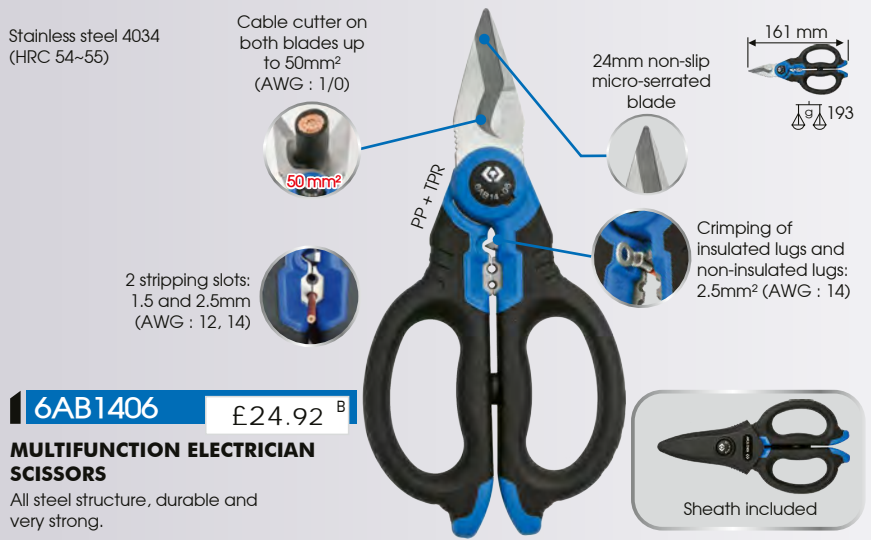

**6AB1406** £24.92<sup>B</sup>

## MULTIFUNCTION ELECTRICIAN SCISSORS

All steel structure, durable and very strong.

Stainless steel



**6AB1255** £10.50<sup>B</sup>

## ELECTRICIAN SCISSORS

Cutting capacity

- electric cable: 10mm
- card: 10mm
- rubber: 10mm
- leather: 10mm
- cold-rolled steel: 0.5mm
- copper: 0.5mm
- aluminum: 0.5mm



Stainless steel AUS-8 (59 HRC)



**6AB1306** £21.36<sup>B</sup>

## ELECTRICIAN SCISSORS

High cutting performances with reduced effort.



**6AB3175** £11.04<sup>B</sup>

## MULTIPURPOSE SCISSORS



# TOOLS FOR ELECTRONICS & ELECTRICITY

Approval:  
 CAT IV 1000,  
 EN 61010-1 : 2010/A1 : 2019,  
 EN 62471 : 2008,  
 EN 61326-1 : 2013,  
 EN 61326-2-2 : 2013



COB LED lighting

Magnetic

Locking

Non-contact voltage detection  
 80 - 1000V AC



- Screwdriver PH2 x1 (65-70 mm)
- Wire cutter Ø 7 mm
- Romex® type NM-B cable stripper 12/2
- Wire stripper 0.5 ~ 8 mm<sup>2</sup> 8 ~ 20 AWG
- Stripping length adjustment

**6CB41**

80~1000 V

£52.51<sup>B</sup>

**9 IN 1 MULTIFUNCTIONAL WIRE STRIPPER**



- Locking
- Wire cutter Ø 6 mm
- Wire stripper 0.8 ~ 2.6 mm<sup>2</sup> 10 ~ 20 AWG
- Pliers
- Cable stripper
- Ø 6 ~ 10 mm Cable stripper

**675144**

£16.38<sup>B</sup>

**MULTI-FUNCTION WIRE STRIPPER**

116



7 PC.

**42107EX**

£123.71<sup>B</sup>

**RATCHETING CRIMPING PLIERS SET WITH INTERCHANGEABLE JAWS**

Ratcheting system providing a complete and even crimping.



Wire stripper (mm<sup>2</sup>)  
 0.9, 1.25, 2, 3.5, 5.5

**676107**

£27.59<sup>B</sup>

**WIRE STRIPPING PLIERS**

Light weight aluminum body  
 Quick adjustment of the desired cable length  
 SK5 knife



- Wire cutter Ø 6 mm
- Crimping of bare terminals 1.5, 2.5, 4, 6 mm<sup>2</sup>
- Bolt cutter M2.5, M3, M3.5, M4, M5
- Crimping of insulated and pre-insulated terminals 0.5, 1, 1.25, 3, 6 mm<sup>2</sup>
- Wire stripper 0.75 ~ 6 mm<sup>2</sup> 10 ~ 22 AWG

**672010**

£28.48<sup>B</sup>

**CRIMPING PLIERS FOR INSULATED CONNECTORS**

**6AG1120**

£1.69<sup>B</sup>

**PVC INSULATED TAPE**

Length: 18 m  
 Width: 18 mm

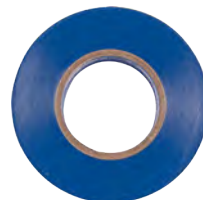

- Wire cutter Ø 5 mm
- Wire stripper 0.05 ~ 3.5 mm<sup>2</sup> 30 ~ 12 AWG

**67A107**

£16.02<sup>B</sup>

**WIRE STRIPPER**



- Wire stripper 0.2 ~ 6.0 mm<sup>2</sup> 24 ~ 10 AWG
- Wire cutter Ø 6 mm
- Insulated terminal crimping 0.5 ~ 6 mm<sup>2</sup> 22 ~ 10 AWG

**676208**

£18.69<sup>B</sup>

**WIRE STRIPPER**



**6AC5126** £154.86<sup>B</sup>

**HEAVY-DUTY CRIMPING PLIERS**

Crimping from 10 to 150 mm<sup>2</sup>.  
Screw adjustment.

Crimping capacity

AWG	8	6	4	2	1/0	2/0	3/0	4/0	300MCM
JIS (mm <sup>2</sup> )	8	14	22	38	60	70	80	100	150
DIN (mm <sup>2</sup> )	10	16	25	35	50	70	95	120	150



**67E208** £21.36<sup>B</sup>

**CABLE TIE FASTEN TOOL**

Manual cutter for tie end. Long stroke to quickly reach the cable-tie. For cable-ties from 2.4 to 9mm wide. For quickly installing ties around cables, wires, sheathing...



**6AC5212** £36.49<sup>B</sup>

**NON-INSULATED CONNECTORS CRIMPING TOOL**

Self-locking ratchet design releases when the correct pressure is applied to ensure precise crimping.

Crimping capacity

AWG	16	14	10	8	6
JIS (mm <sup>2</sup> )	1.25	2	5.5	8	14
DIN (mm <sup>2</sup> )	1.5	2.5	6	10	16



For non-insulated connectors.

520

**SOLDERING**



**6AF11125** £3.47<sup>B</sup>

**CROSS LOCKING**



**6AF21165** £3.38<sup>B</sup>

**CROSS LOCKING ACTION TWEEZERS**

Stainless steel with half-round tips.  
For holding small parts in place during soldering or cleaning.  
Cross locking tips.  
Polished finish.



**6BF1125** £24.03<sup>B</sup>

**SOLDER WIRE**

Material : 60% tin and 40% lead.  
For use on Electronic circuits.  
Flux stream incorporated into the wire.  
A11 rosin flux (no-clean) incorporated into the wire.



**6BC3007** £56.07<sup>B</sup>

**GAS SOLDERING IRON**

Power range: 30 W - 150 W.  
Cordless.  
Four different tips.  
Adjustable soldering temperature : 400 °C ~ 450 °C (750 °F ~ 840 °F).  
Fuel tank for 90 minutes of operation.  
Torch temperature: 1300 °C (2400 °F).  
Fuel capacity: 20 ml.  
Ready to use 45 seconds after ignition.



8 PC.



**6BC141** £29.37<sup>B</sup>

**SOLDERING IRON**

220V / 240V, 30W.  
For Electrical and stained glass work.  
Lightweight handle.  
Replaceable tip.  
Spare bit (6BC1411).



**6BD11** £5.34<sup>B</sup>

**DESOLDERING PUMP**

Desoldering pump strong suction mechanism.  
ABS body plastic.  
interchangeable bit (6BD111).

# VOLTAGE TESTER



160 x 20 x 24 mm

EN 61000-6-3 / EN 61000-6-1 CAT III.

**6CB31**

80~1000V AC

£17.80<sup>B</sup>

### NON-CONTACT VOLTAGE TESTER



Voltage range : from 80 to 1000 V AC (50-60 Hz).  
Adjustable sensitivity.  
Locates electrical voltage on cables and plugs.  
Detects line breaks on wires and cables.  
Switch off button.  
Low voltage (L): red light.  
High voltage (H): green light.



**9DC22**

6~24V DC

£7.03<sup>B</sup>

### CIRCUIT TESTER

Test voltage 6 ~ 24V for use on D.C. circuits only.  
LED testing.  
Cover cap for contact needle.  
Interchangeable bulb (24V/3W).  
90 cm cable. Bronze body housing.



**9DC23**

3~48V DC

£9.79<sup>B</sup>

### VOLTAGE TESTER

Test voltage 3 ~ 48V for use on D.C. circuits only.  
Insulated alligator clip with 150 cm cable. 2 LED indicate positive(+) / negative(-) polarity.

2 test positions:



**9DC242**

6~24V DC

£42.72<sup>B</sup>

### DIGITAL DISPLAY CIRCUIT TESTER

For 6/12/24V DC circuits only.  
Checks if the circuit is electrified or not by stainless steel stylus.  
Powered from the power source being measured, no batteries required.  
3 M long retractable cable.  
Bigger heavy duty insulated alligator ground clip.  
CE approval EN 61000-6-3(2007), EN 61000-6-1(2007)



Do not use on air bags.



**6CB21**

£61.41<sup>B</sup>

### DIGITAL VOLTAGE TESTER

Test high and low voltage quickly and safely in engines, cars, hydroelectric energy, etc. Self-Diagnostic test. Phase detection. Phase rotation test. LED light. LCD screen.

### TECHNICAL INFORMATION

DC Voltage Test	12, 24, 50, 120, 230, 400, 690V
AC Voltage Test	12, 24, 50, 120, 230, 400, 690V
High voltage indication	≥ 50V
Frequency range	0-70Hz
Continuity test	0~550KΩ
Working temperature	-10~55°C
Dimension	255 x 66 x 30 mm
Weight	250 g
Approval	EN 61243-3 / IEC 61243-3, EN 61010-1 / IEC 61010-1, CAT.III 690V / CAT.IV 600V

# MEASURING TOOLS



**9DM1361** £66.75<sup>B</sup>

### DIGITAL MULTIMETER

Automatic switch off. Automatic calibre selection. Negative polarity indicator (no indicator for positive polarity). Low energy consumption.



#### TECHNICAL INFORMATION

DC voltage (0.1mV ~ 1V)	200mV / 2V / 20V / 200V / 600V		
AC voltage (0.001V ~ 1V)	2V / 20V / 200V / 600V		
DC amps (0.1uA ~ 0.01A)	200uA / 2000uA / 20mA / 2A / 10A		
AC Amps (0.1uA ~ 10A)	200uA / 2000uA / 20mA / 2A / 10A		
Resistance (0.1Ω ~ 0.01MΩ)	200Ω / 2kΩ / 20kΩ / 200kΩ / 2MΩ / 20MΩ		
Continuity test	yes	Continuity test	yes
Low battery indicator	yes	Hfe(NPN, PNP)	yes
LCD display	3-1/2 digits 1999 points		
Sampling rate	3 times per second		
Dimension	138 x 70 x 32 mm	Weight	262 g
Approval	CE EN61010-1, 600V CATII, 300V CATIII		

**New**

Available in February

**6DM1392** £134.39<sup>B</sup>



### DIGITAL MULTIMETER TRMS

Measurement functions: true root mean square (TRMS), DC/AC voltage (DC/AC), DC/AC current (DC/AC), resistance, capacitance, temperature, capacitor test (CAP), frequency (Hz) and non-contact voltage detection (NCV = Non-Contact Voltage).

- Auto Power off
- Back-light LED screen for easier reading
- With accessories: thermocouple and type K connector.



#### TECHNICAL INFORMATION

DC voltage (0.1mV ~ 1V)	1000V	
AC voltage (0.001V ~ 1V)	750V	
DC amps (0.1uA ~ 0.01A)	10A	
AC Amps (0.1uA ~ 10A)	10A	
Resistance (0.1Ω ~ 0.01MΩ)	50MΩ	
Positive contact	Chromel™	Negative contact Alumel™
Low battery indicator	yes	
LCD display	600 points, 3-6/7 digits with automatic unit and polarity	
Sampling rate	3 times per second	
Dimension	90 x 180 x 46 mm	Weight 705 g
Approval	EN61326-1:2021, EN61326-2-2:2021 600V : CAT.IV, 1000V : CAT.III	



**9DM2351** £123.71<sup>B</sup>

### AC CLAMP METER

Overload indicator: "OL" and beep. Max clamp size: Ø 30 mm. Negative polarity indicator (no indication for positive polarity). Auto switch off after 15 minutes. Low energy consumption. Removable test cables. Easy to use. Sold in a storage pouch.

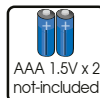

#### TECHNICAL INFORMATION

AC Amps (0.1A - 1A)	200A / 600A	
AC voltage (0.001V - 1V)	2V / 20V / 200V / 600V	
DC voltage (0.1mV - 1V)	200mV / 2V / 20V / 200V / 600V	
Resistance (0.1Ω - 0.01MΩ)	200Ω / 2kΩ / 20kΩ / 200kΩ / 2MΩ / 20MΩ	
Continuity test	yes	Diode test yes
Low battery indicator	yes	
LCD display	3-1/2 digits 1999 points	
Sampling rate	3 times per second	
Dimension	189 x 71 x 37 mm	Weight 354 g
Approval	CE IEC 61010-1, IEC 61010-2-032 CAT.III 600V Pollution degree 2	



**9DM2352 AC-DC** £177.11<sup>B</sup>

### AC/DC CLAMP METER

Overload indicator: "OL" and beep. Max clamp size: Ø 30 mm. Negative polarity indicator (no indication for positive polarity). Auto switch off after 15 minutes. Low energy consumption. Removable test cables. Easy to use. Sold in a storage pouch.



#### TECHNICAL INFORMATION

AC Amps (0.1A - 1A)	400A / 600A	
DC amps (0.1A - 1A)	400A / 600A	
AC voltage (0.001V - 1V)	4V / 40V / 400V / 600V	
DC voltage (0.1mV - 1V)	400mV / 4V / 40V / 400V / 600V	
Hz frequency	5Hz / 50Hz / 500Hz / 5kHz / 50kHz / 100kHz	
Resistance (0.1Ω - 0.01MΩ)	400Ω / 4kΩ / 40kΩ / 400kΩ / 4MΩ / 40MΩ	
Continuity test	yes	Diode test yes
Low battery indicator	yes	
LCD display	3-1/2 digits 1999 points	
Sampling rate	3 times per second	
Dimension	117 x 76 x 18 mm	Weight 402 g
Approval	CE IEC 61010-1, IEC 61010-2-032 CAT.III 600V Pollution degree 2	



**9DN12** £103.24<sup>B</sup>

### INFRARED THERMOMETER

Contactless thermometer IR point can be displayed clearly. Easy to use with its 4 buttons. Emissivity selection 0.85 / 0.90 / 0.95. °C / °F selection. Laser pointer ON/OFF. Backlit display.



#### TECHNICAL INFORMATION

Temperature range	-30 to 550°C (-22 to 1022°F)	
Operating temperature	0~50° C	
Humidity	80% RH	
Resolution	0.1°C / 0.1°F	
Accuracy	±2.5% ou 3°C	
Emissivity Selectable	0.85 / 0.90 / 0.95 (numerical adjustment)	
Distance to spot ratio	12:1	
Auto power off	15 seconds	
Laser pointer	Class 2 Laser < 1 mW	
Dimension	193 x 47 x 126 mm	Weight 313 g

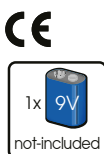



LIFETIME GUARANTEE



#9 (280 x 375 mm) IEC 60900:2012, VDE/GS

**955VE01MRV** 1/4" + 3/8" £520.65<sup>B</sup>

Contents		Weight
2335VE	5, 6, 7, 8, 9, 10, 11, 12, 13, 14	2.56
2035VE	H3, H4, H5, H6	
2221VE04, 2221VE06		
2771VE55	2178VE05	
3335VE	10, 11, 12, 13, 14, 15, 16, 17, 18, 19	
3235VE	8, 10, 12, 14	
3025VE	H8, H10	
3221VE06, 3221VE10		
3771VE08	3178VE08	

## 1000 V INSULATED TOOLS - VDE AND GS CERTIFIED



372 x 422 x 92 mm

**30VE31MPV** 3/8" £444.11<sup>B</sup>

Contents		Weight
3335VE	6, 7, 8, 9, 10, 11, 12, 13, 14, 15, 16, 17, 18, 19	4.21
10F0VE	7, 8, 10, 12, 14	
3221VE06, 3221VE10		
1471	PH1 x 100, PH2 x 100	
1472	3 x 75, 4 x 100, 5.5 x 125	
3771VE08	611607A, 621606A, 631808A	
6CB02		



389 x 229 x 66 mm IEC 60900:2012, VDE/GS

**45VE01MRV** 1/2" £319.51<sup>B</sup>

Contents		Weight
4335VE	8, 10, 12, 13, 14, 17, 19, 21, 22, 24	3.22
4025VE	H8, H10	
4251VE05, 4251VE10		
4771VE10	4178VE08	



INSULATED SCREWDRIVERS SET IEC 60900:2012, VDE/GS

**30617MR** £36.49<sup>B</sup>

Contents		Weight
1471	PH1x100, PH2x100, PH3x150	860
1472	4x100, 5.5x125, 6.5x150, 8x175	

**30607MR** £36.49<sup>B</sup>

Contents		Weight
1478	PZ1x100, PZ2x100, PZ3x150	860
1472	4x100, 5.5x125, 6.5x150, 8x175	



294 x 231 x 66 mm IEC 60900:2012, VDE/GS

**25VE01MRV** 1/4" £230.51<sup>B</sup>

Contents		Weight
2335VE	5, 6, 7, 8, 9, 10, 11, 12, 13, 14	1.30
2035VE	H3, H4, H5, H6	
2221VE04, 2221VE06		
2771VE55	2178VE05	



369 x 229 x 66 mm IEC 60900:2012, VDE/GS

**35VE01MRV** 3/8" £248.31<sup>B</sup>

Contents		Weight
3335VE	10, 11, 12, 13, 14, 17, 19	2.16
3025VE	H5, H6, H8	
3221VE06, 3221VE10		
3771VE08	3178VE08	

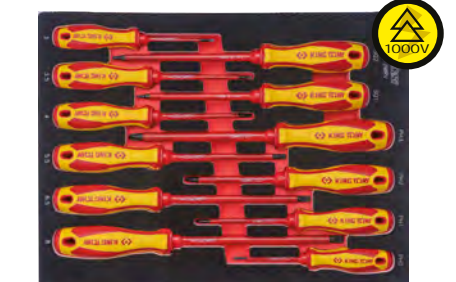

#9 (280 x 375 mm) IEC DIN EN 60900, VDE/GS

**930612MRV** £85.44<sup>B</sup>

Contents		Weight
1471	PH0x75, PH1x100, PH2x100, PH3x150	1.30
1472	3x75, 4x100, 3.5x100, 5.5x125, 6.5x150, 8x175	
1474	1 x 125, 2 x 150	





LIFETIME GUARANTEE



Coarse serrated

Cutting edges with bevel

IEC DIN EN 60900, VDE/GS

**6116A****VDE INSULATED COMBINATION PLIERS**£19.85<sup>B</sup>

L mm	Cutting Capacities (Ø mm)	
185	4.0 Soft wire	290
	3.0 Semi-soft wire	
	2.0 Hard wire	
	1.6 Plano wire	

£23.14<sup>B</sup>

L mm	Cutting Capacities (Ø mm)	
200	4.0 Soft wire	386
	3.0 Semi-soft wire	
	2.0 Hard wire	
	1.6 Plano wire	



Cutting edges with bevel

IEC DIN EN 60900, VDE/GS

**621606A**£19.58<sup>B</sup>**VDE INSULATED DIAGONAL CUTTING PLIERS**

L mm	Cutting Capacities (Ø mm)	
167	4.0 Soft wire	230
	2.8 Semi-soft wire	
	2.0 Hard wire	
	1.6 Plano wire	

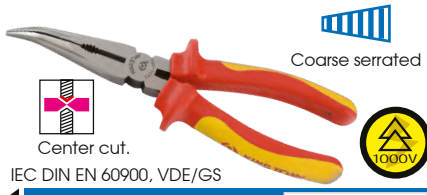

Coarse serrated

Center cut.

IEC DIN EN 60900, VDE/GS

**633608A**£23.41<sup>B</sup>**INSULATED BENT NOSE PLIERS**

L mm	Cutting Capacities (Ø mm)	
200	4.0 Soft wire	250
	3.0 Semi-soft wire	
	2.0 Hard wire	
	1.6 Plano wire	



IEC 60900:2012, VDE/GS

**40603GP**£63.19<sup>B</sup>**INSULATED PLIERS SET**

Contents			
611607A	621606A	631808A	890

Coarse serrated  
IEC 60900:2012, VDE/GS**651610A**£25.81<sup>B</sup>**VDE INSULATED GROOVE JOINT PLIERS**

L mm	A mm	B mm	C mm	Number of positions	
250	55	63	36	7	420

Short flat nose



IEC DIN EN 60900, VDE/GS

**671606A**£25.81<sup>B</sup>**VDE INSULATED STRIPPING PLIERS**Wire stripper 0.8 à 5 mm  
Integrated wire cutter

L (mm)	Ø (mm)	Wire stripper (mm <sup>2</sup> )	
160	5	10	205



#9 (280 x 375 mm) IEC DIN EN 60900, VDE/GS

**940605GPV**£146.85<sup>B</sup>

Contents

Contents				
611607A	621606A	631808A	633608A	1.77
651610A				

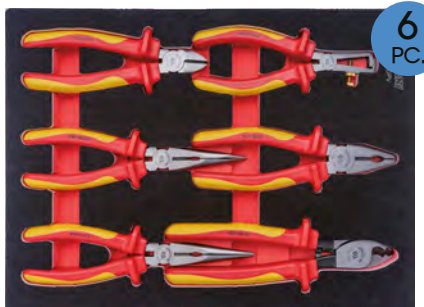

#9 (280 x 375 mm) IEC DIN EN 60900, VDE/GS

**940606GPV**£183.34<sup>B</sup>

Contents

Contents				
611607A	631808A	614608A	621606A	1.88
633608A	671606A			



IEC 60900:2012, VDE/GS

**3611VE****INSULATED ADJUSTABLE WRENCH**

	mm	L mm		
3611VE06	24	164	167	£36.49 <sup>B</sup>
3611VE08	28	212	273	£46.28 <sup>B</sup>
3611VE10	32	260	497	£56.96 <sup>B</sup>
3611VE12	38	310	679	£74.76 <sup>B</sup>

**INSULATED OPEN END WRENCH SET**

IEC 60900:2012, VDE/GS

**12FVE08MRN**£145.07<sup>B</sup>

Contents

Contents		
10FOVE	10, 11, 12, 13, 14, 17, 18, 19	910

**12FVE10MRN**£188.68<sup>B</sup>

Contents

Contents		
10FOVE	10, 11, 12, 13, 14, 16, 17, 18, 19, 22	1.28



#9 (280 x 375 mm) IEC 60900:2012, VDE/GS

**912FVE15MRV**£328.41<sup>B</sup>

Contents

Contents		
10FOVE	7, 8, 9, 10, 11, 12, 13, 14, 16, 17, 18, 19, 21, 22, 24	1.96



#9 (280 x 375 mm) IEC 60900:2012, VDE/GS

**912FVG15MRV**£426.31<sup>B</sup>

Contents

Contents		
10GOVE	7, 8, 9, 10, 11, 12, 13, 14, 16, 17, 18, 19, 21, 22, 24	2.86

# 86 TOOLS SET



**934086MRVD** 1/4" + 3/8" £1,307.41<sup>D</sup>

**Contents**

2335VE 5, 6, 7, 8, 9, 10, 11, 12, 13, 14	1471 PH0 x 75, PH1 x 100, PH2 x 100, PH3 x 150	611607A	614608A
2035VE H3, H4, H5, H6	1472 3 x 75, 4 x 100, 3.5 x 100, 5.5 x 125, 6.5 x 150, 8 x 175	621606A	631808A
2221VE04, 2221VE06	1474 RB1 x 125, RB2 x 150	633608A	671606A
2771VE55  2178VE05	10F0VE 7, 8, 9, 10, 11, 12, 13, 14, 16, 17, 18, 19, 21, 22, 24	10G0VE 7, 8, 9, 10, 11, 12, 13, 14, 16, 17, 18, 19, 21, 22, 24	
3335VE 10, 11, 12, 13, 14, 15, 16, 17, 18, 19			
3235VE 8, 10, 12, 14			
3025VE H8, H10			
3221VE06, 3221VE10			
3771VE08  3178VE08			

1/4" 3/8" LIFETIME GUARANTEE 86 PC.

## OPTIONAL

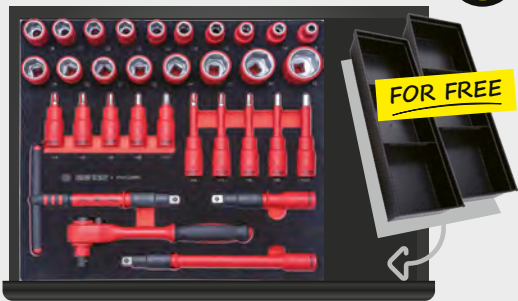

**945VE02MRVP 1/2" £515.31<sup>B</sup>**

**Contents**

4335VE 8, 10, 11, 12, 13, 14, 15, 16, 17, 18, 19, 20, 21, 22, 24, 27, 30, 32	4025VE H4, H5, H6, H8, H10	4035VE H4, H5, H6, H8, H10
4251VE05, 4251VE10	4771VE10  4178VE08  8470001BS2	

32 PC.



37 PC.

## TOOL SET FOR ELECTRICIANS

**Contents**



1471 PH0 x 75, PH1 x 100, PH2 x 100	1472 3 x 75, 4 x 100, 5.5 x 125, 6.5 x 150	1120MR H1.5, H2, H2.5, H3, H4, H5, H6, H8, H10
671606A  621606A  633608A	631808A  614608A  20002UB	3611VE08  361110R
651110  631108  9CJ1120  7909505M	6CB21  6CB02  67B355  67A107	6AG1120  7622308  7621010  782150  874052

**9052001MRV £444.11<sup>D</sup>**

## 1000 V INSULATED TOOLS



**1451VE11 £52.51<sup>D</sup>**

NF EN 60900 / CEI 60900 11 mm  
**1000 V INSULATED SCREWDRIVER FOR TRIANGULAR SCREWS**  
 Allows to work on the triangular screws of the connection boxes. Blade in treated steel. Body made of acetate. 1000 V insulated body, except for the tip to facilitate penetration into screw holes. Burnished tip.



1 YEAR GUARANTEE



Quick adjustment of the tightening torque by screwing or unscrewing the thumb wheel.

TOLERANCE +/- 3%



**3432VE20M £559.81<sup>D</sup>**

NF EN 60900 / CEI 60900 / NF EN ISO 6789-1-2017  
**1000 V INSULATED TORQUE WRENCH**  
 Type II - Class A.  
 ±3% torque accuracy (clockwise).  
 Clockwise (CW) triggering.



**Torque range**

Square drive	<b>Nm</b>	Incr.	<b>lbf.in</b>	Number of teeth	Total length mm
<b>3432VE20M</b>	3/8"	4-20 Nm	1 Nm	40-180 lbf.in	72 230

65  
PC.

**New**

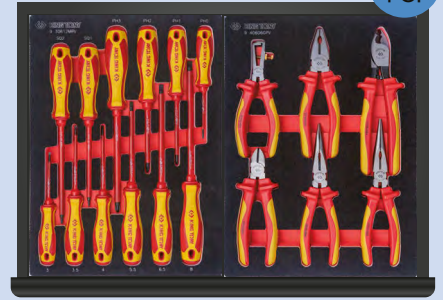

IEC DIN EN 60900, VDE/GS

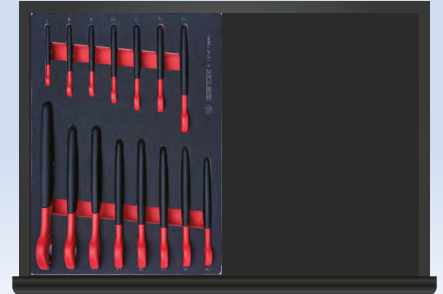

IEC 60900:2012, VDE/GS

**6  
DRAWERS**

**BASIC  
series**

**PKTPEQ01**



1/2"

£1,378.61<sup>D</sup>

**TOOL TROLLEY 87G386BA  
+ SET OF 65 VDE TOOLS**

Specifications	Dimensions (mm) L x D x H		kg
	Total excl. wheels	760 x 458 x 809	
87G386BA	Total + Ø127x50 mm wheels	760 x 458 x 969	53.7
	3 drawers	570 x 380 x 72	
	3 drawers	570 x 380 x 149.5	

Contents		62.91		
	8, 10, 11, 12, 13, 14, 15, 16, 17, 18, 19, 20, 21, 22, 24, 27, 30, 32			
	H4, H5, H6, H8, H10			
	H4, H5, H6, H8, H10		PH0x75, PH1x100, PH2x100, PH3x150	
			3x75, 4x100, 3.5x100, 5.5x125, 6.5x150, 8x175	
			1x125, 2x150	
	7, 8, 9, 10, 11, 12, 13, 14, 16, 17, 18, 19, 21, 22, 24			

**New**

34  
PC.



470 x 210 x 206 mm

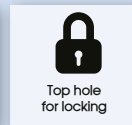
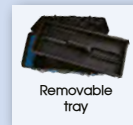

**PKTPEQVEH**



3/8"

£427.20<sup>D</sup>

**COMPLETE VDE TOOL BOX FOR HYBRID AND ELECTRIC VEHICLES**

5.63

Contents		5.63		
	6, 8, 9, 10, 11, 12, 13, 14, 15, 16, 17, 18, 19, 20, 22			
	H8, H10			
			PH1x100, PH2x100, PH3x150	
			4x100, 3.5x100, 5.5x125	
			TC25	

**New**



**8**  
PC.



**PKTPEQCP**

£204.70<sup>D</sup>

**VDE CONSIGNMENT PACK**

0.70

Contents

	CSKD1P438
	CSKD1P476
	TS20
	TS21
	TC30, TC40
	TP60P
	TN17066M

**New**



**4**  
PC.



**PKTPEQG1**

£422.75<sup>D</sup>

**VDE PPE EQUIPMENT PACK  
SIZE 10 GLOVES**

**PKTPEQG2**

£422.75<sup>D</sup>

**VDE PPE EQUIPMENT PACK  
SIZE 9 GLOVES**

Contents

0.978

	GLE36010
	GLE36009
	TAG780VIFE
	RGXSGC
	V1BK



# KING TONY



# PENTA

ELECTRICAL SAFETY PRODUCTS



1 YEAR GUARANTEE

## 1000V INSULATED TOOLS

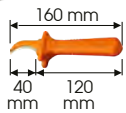

NF EN 60900 / IEC 60900 / FT BT 405

**IS79** £40.05<sup>D</sup>

### INSULATED KNIFE WITH SHORT BLADE

Designed for stripping small section cables. Stainless steel blade. Electropolishing finish for a durable sharpness. Weighted handle for a good balance and to avoid tool from falling on the blade. Insulated blade rigide to protect from short circuit.



NF EN 60900 / IEC 60900 / FT BT 405

**IS77** £47.17<sup>D</sup>

### 1000V INSULATED KNIFE WITH LONG THICK BLADE

Recommended for stripping cables. Overhead or underground network, indoor installation. Stainless steel blade, injection insulation. Electropolishing finish for a durable sharpness. Weighted handle for a good balance and to avoid tool from falling on the blade. Insulated blade rigide to protect from short circuit.



Hand guard to avoid hand slipping.

Grip designed to improve handling.

Ergonomic tool.

High cutting performance : accurate cutting, gesture control.

NF EN 60900 / IEC 60900

**IS80C** £152.19<sup>D</sup>

**INSULATING KNIFE WITH CERAMIC BLADE**

Knife for stripping plastic sheaths from electrical cables. This tool doesn't cut metal strip. Ceramic blades, contains absolutely no metal parts for product safety. Stainless ceramic blades, no wear, no sharpening.

200 mm

65 mm 135 mm

1000V

70

Shank Length 35 mm

NF EN 60900 / IEC 60900

**MS2E** £101.46<sup>D</sup>

**INSULATED ELECTRICIAN SCISSORS**

Stainless steel, long sharp shears with wire cutters. Ambidextrous model, for right and left handed users. Large size finger rings particularly suitable for use with insulating and overgloves. Case not included.

76

560 mm

440 mm

NF EN 60900 / IEC 60900

**TFA** £121.04<sup>D</sup>

**1000V INSULATED HANDLE WITH FLEXIBLE SHAFT AND MAGNETIC TIP**

This tool, consisting of a handle and a flexible rod with a magnet at its tip, is designed to access and retrieve small metal components (such as screws, nuts, washers, etc.) in hard-to-reach areas. Maximum load/lift force: 120 g.

150

1000V

1000V

**TC120** £15.13<sup>D</sup>

**INSULATING WEDGE**

Both sides of the corner are notched with 4 half-round grooves to separate the conductors from twisted cables. Made of polyamide 6.

90

# SAFETY EQUIPMENT



**TAG780VIFE** £193.13<sup>D</sup>

**LV VOLTAGE DETECTOR**

In the context of consignment, TAG780V enables checking the absence of voltage. This device provides additional features as phase search, continuity test, voltage level...)

Audible alarm indicating the presence of voltage with a different tone according to voltage level (discontinuous tone up to 230V and continuous tone above 400V).

Polarity display (-/+)

Integrated self-test.

Phase search in single-pole mode (use of one or the other key points).

Front light.

Unique bright LED display can be read in sunlight.

Ultra flexible cord (no memory effect).

A revolutionary IP2X system (retractable tipsleeve): "pull and hold" grip at back of device.

**TECHNICAL INFORMATION**

DC Voltage Test	12, 24, 50, 127, 230, 400, 690, 1000 V
AC Voltage Test	12, 24, 50, 127, 230, 400, 690, 1000 V
Frequency range	15 - 60 Hz
Continuity test	<80 Ω
Approval	IEC 61243-3, CAT.IV 1 000 V, IP2X, IP65

Includes: Saddlebag, AAA 1.5V x 2 included, IP65 protection.



**TP12EC** £111.25<sup>D</sup>

**INSULATING RESCUE STICK**

Stick for rescuing an injured technician (electrocution, dizziness...), working on category 1, 2 and 3 substations. Designed to grab an injured person by the waist and bring them back to a safe area.

Test voltage over 300 mm: 100 kV.

Hook : steel tube 18 x 1,5 cm.

Body stick 45 kV with hook and without protection guard.

Total length without hook (m) : 1.47.

Supplied with 2 supports and a hook.



**S115RB8** £158.42<sup>D</sup>

**HIGH-DENSITY POLYETHYLENE MARKER CHAIN**

Resistant. Anti-UV. Supplied in a bag.

∅ Chain	8 mm
Chain Length	25 mm

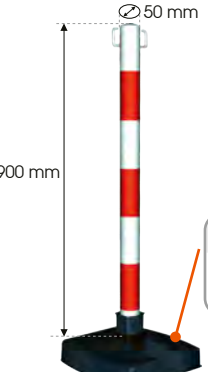

**S115SPPR** £214.49<sup>D</sup>

**POLE ON BASE FOR PLASTIC MARKUP CHAINS**

Designed for exterior demarcation. Locking device allows to block the post in two different positions. Fold-down system saves up to 70% of storage space.

1 weighted base and 1 ready to use base.

Base weight: 4 kg  
Base dimensions: 280 x 280 x 70 mm



**TS20**



**TS21**

**INSULATING BAG FOR CONNECTORS**

Used on overhead power lines and inside installations. Placed under a fixed connector at the free end of a conductor wire, this insulating bag is used to prevent accidental contact between the connector and a conducting component carrying a different potential.

For working by contact, by pulling the bag grip ring or by tilting and sliding the bag over the connector's length until its is clear.

Made of transparent polyvinyl. Velcro fastening.

	Length (mm)	Width (mm)	Price
TS20	210	130	£24.92 <sup>D</sup>
TS21	305	225	£34.71 <sup>D</sup>



**TN17066M** £37.38<sup>D</sup>

**INSULATING SHEET WITH ADHESIVE STRIPS (VELCRO)**

Insulation by cladding of low-voltage network conductive parts. Several sheets may be added together.

660 x 360 mm



**TP60P** £6.23<sup>D</sup>

**PLASTIC FIXING CLIP 1000 V**

Used to fix and hold in position temporary insulation like insulating sheets. Pinching capacity : 25 mm. Weather resistant. For overhead network, underground network and indoor installations.



**TC**

**LV INSULATING CAP FOR CONDUCTOR ENDS**

Used for overhead and underground networks and indoor installations. Designed to cover the stripped end of an insulated conductor during operations (the stripped end length should be no longer than the cap length minus 10 mm). Opening with a cross-shaped cut-out for inserting a conductor. Cylindrical cap made of soft insulating material. Sold per unit, order in multiples of 4 for each LV conductor.

	Length (mm)	ø hose outside (mm)	Capacity (mm <sup>2</sup> )	ø max (mm)	
TC25	60	10	3 - 10	6.5	£ 3.20 <sup>D</sup>
TC30	100	15	6 - 35	11	£ 4.45 <sup>D</sup>
TC35	120	20	20 - 70	15	£ 5.34 <sup>D</sup>
TC40	120	25	30 - 100	20	£ 5.34 <sup>D</sup>
TC41	120	35	240	30	£ 15.13 <sup>D</sup>

UV-resistant transparent door with locking handle that can accommodate a seal or padlock (max. Ø 4.8 mm shackle).

Weatherproof plastic case, resistant to weather, dust, splashes and marine spray (IP54).

IP54

9.5

**PS2PM** £494.84 <sup>D</sup>

**WATERPROOF STORAGE CASE FOR RESCUE EQUIPMENT**

Designed to stock rescue kit for intervention to rescue a victim in the event of an incident on or near a low voltage electrical installation. Indoor or outdoor use. Equipment mounting insert optimized for efficient storage and quick response. Quick access wall-mounted rescue kit for intervention to rescue a victim in the event of an incident on or near a low voltage electrical installation. Lockable case to prevent the borrowing of material. Wall mounting kit included. Empty box, delivered without components, poster nor tray.

4.5 mm in diameter

38 mm

76 mm

82

84

**CSKD 1P438** £47.17 <sup>D</sup>

**CSKD 1P476** £48.06 <sup>D</sup>

**LOCKOUT PADLOCK WITH INTERCHANGEABLE SHACKLE AND HIGH SECURITY KEY**

For lockout procedure following the 5 lockout-tagout steps. Keyed different : each padlock has its unique key, the key can open only one padlock and no others. Padlock with non-metallic body. Composite shackles. Interchangeable shackle system allows quick adaptation of the shackle to the installation to lock out without needing to change the padlock. Keys combining punches and grooves for high security levels. Over 1,000,000 possible blade profile variations. Locked key system: the key cannot be removed until the padlock is locked. Automatic keyreturn cylinder.

Includes :  
1 mounted handle,  
1 adhesive labels set in 6 languages (UV and abrasive resistant),  
1 user manual.

**PERSONAL PROTECTIVE EQUIPMENT**



**New**

0.9

Screen marking : 2C-1.2 1 ET9KN  
Eyes protection norms : EN 166, EN 170, GS-ET-29, EN ISO16321-1  
IEC 62819 : APC1, EN 397, EN 50365:2023, GS-ET-29 : APC1  
GS-ET-29: Light Transmittance : 0

**V1BK** £208.26 <sup>D</sup>

**SAFETY HELMET WITH INTEGRATED FACE SHIELD FOR ELECTRICIANS**

- Modern, ergonomic design.
- Double shell for optimum protection of the face shield, prolonging its life and providing superior protection against electrical and arc-flash risks.
- Perfectly balanced helmet, offering optimum protection for electricians in all types of industrial environments.
- Fold-down headband adjustment system for optimum storage.
- High level of VLT (Visible Light Transmittance) for enhanced visibility.
- Colourless screen with perfect optical quality (patented technology) for prolonged wear, without distortion or visual fatigue.
- Anti-fog properties on the inside of the screen & anti-scratch properties on the outside of the screen.

Shell material : ABS  
Helmet harness adjustment : rack  
Head size (cm) : 53-62  
Neckband material : foam  
Fixing points : 6 points  
Jugular points : 4 points  
Lifespan from first use : 60 months



410  
Eyes protection norms : EN 166, EN 167, EN 168, EN 170

**E24** £93.45 <sup>D</sup>

**ELECTRICIAN FACE SHIELD WITH HEADBAND AND BROW-GUARD**

Protection of eyes, face and top of the head against electrical short circuit arc. Designed for intervention on or near low tension facilities. Set includes 1 screen support and 1 face shield. Holder designed with a blue PP front hull, an adjustable handband (53 to 61 cm) and comfort sweatproof foam band. Lifting face screen with 2 lateral wheels.

Marking:  
- 2C = 100% UV filtration  
- 1,2 = colorless eyepiece passing 91.2% of the visible light  
- 1 = optical quality / Class 1, without deformation during permanent wear  
- AT = Strong impact resistance speed: 190 m / sec between -5 °C and + 55 °C  
- 8 = Short circuit arc protection  
- 9 = Resistance to molten metal and hot particles



EN 60903 / IEC 60903

**EOS9030**

£202.92<sup>D</sup>

**PNEUMATIC GLOVES TESTER FLEX&GRIP AND ELECTROVOLT GLE**



This pneumatic inflator allows you to check the insulating gloves' integrity before using them. Visual inspection by inflation, according to the recommendations of 60903 standards (EN and IEC). Moulded plastic body with:

- a conical tip with two grooves meant to receive the glove to be tested,
- a central piston, located at the base of the device,
- a flexible valve located at the bottom of the bowl,
- two elastic rings meant to hold the glove in place during inflation.

**EOSE9030**

£202.92<sup>D</sup>

**PNEUMATIC GLOVES TESTER TOUCH-E**



Class 0  
EN 60903 / IEC 60903

**GICNBT**

**COMPOSITE INSULATING GLOVES - FLEX&GRIP**

Composite insulating gloves for safe working without leather overgloves. Designed for high mechanical risk maintenance operations. Special properties (category) RC, with mechanical protection. Made of high performance polymer blend providing mechanical, chemical and dielectric resistance. Specially formulated outer coating ensuring exceptional grip, even in wet or greasy conditions. Each pair of insulating gloves includes a pair of cotton under-gloves, allowing sweat absorption and overall better hygiene, while preserving dexterity.

	Length (mm)	Size	Thickness (mm)	
GICNBT09	410	9	< 2.9	£91.67 <sup>D</sup>
GICNBT10	410	10	< 2.9	£91.67 <sup>D</sup>



Category : A, Z, C  
CE category : Category 3  
EN 388 : 1121X - IEC 61482 - ASTM F2675

**JFO360**

**NATURAL RUBBER INSULATING GLOVES - TOUCH-E**

Orange natural rubber insulating gloves. The thinness and grip area make them easy to handle. Excellent dexterity. Touch-sensitive. Arm level protection : Forearm cuff (< 400mm) Coating material : Latex Coating level : Fully coated Number of layer : Single layer Electrical gloves cuff characteristic : Not bypassed Max voltage use : Alternative (V AC)

	Length (mm)	Size	
JFO36009	360	9	£72.09 <sup>D</sup>
JFO36010	360	10	£72.09 <sup>D</sup>



EN 388 : 2122X



**RGXSG**

**LEATHER OVERGLOVE FOR MECHANICAL PROTECTION OF LATEX GLOVES**

Leather gloves with split leather cuff. Leather protectors are recommended to be worn over insulating rubber gloves to ensure mechanical protection (local regulations, work practices and risk analysis apply). Specifically designed to fit over the Electrovolt gloves in order to ensure a good level of dexterity. Adjustable cuff strap. Palm and back in cowhide leather, with full-grain and waterproof leather finish. Water-repellent treatment.

	Length (mm)	Size	
RGXSCB	100	B	£34.71 <sup>D</sup>
RGXSCC	100	C	£34.71 <sup>D</sup>



Class 00  
Category : A, Z, C  
EN 60903 / IEC 60903

**GLE360**

**NATURAL RUBBER INSULATING GLOVES - ELECTROVOLT GLE**

Hand insulation according to class and nominal mains voltage. Use with a leather overglove for mechanical protection. Natural rubber insulating beige gloves with cut edges. Ergonomically shaped glove and lightly powdered on the inside for easy insertion and removal of the glove. The natural rubber structure provides high dielectric properties; its thickness protects while ensuring excellent dexterity.

	Thickness (mm)	Size	
GLE36009	< 1.6 mm	9	£48.06 <sup>D</sup>
GLE36010	< 1.6 mm	10	£48.06 <sup>D</sup>



**RGXSAC**

£33.82<sup>D</sup>

**TEXTILE STORAGE BAG FOR INSULATING GLOVES**

Case designed for transporting short insulating gloves, providing mechanical protection and UV protection. Compartment with flap and snap closure, including a flat see-through pocket for storing user manual and an open side pocket to store talc bottle. No sharp or pointed edge in contact with the gloves Polyester canvas with waterproof PVC coating.



# SECURITY RANGE

100 sheets

Lemon oil formula



No water required

**ZD101100C** £23.14<sup>B</sup>

**MULTI PURPOSE WIPES**

Get rid of grease, oil, tar, paint, dirt, silicone, adhesives and more. Quick cleansing and time-efficient. Effectively cleans and protects hands from all types of dirt without using toxic solvents. Eliminates up to 99.99% of bacteria. *Non-REACH SVHC candidate list. Non-CA Prop 65 list of chemicals. Non-toxic solvents by SGS.*

Suitable for cleaning hands, surfaces, and tools

**New**

12 PAIRS

**9TH11**

**BOX OF 12 PAIRS OF WORK GLOVES**

Nitrile coating offers high dexterity, sensitivity, excellent grip and good comfort. Those gloves Provide a good grip and excellent abrasion resistance. No more trouble : these gloves allow you to handle your touch screens and electronic devices without removing them.

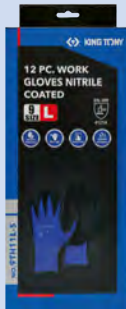

EN ISO 21420, EN388 4121X

Length (mm) Size

9TH11ALS	245	L / 9	500	£37.38 <sup>B</sup>
9TH11AXLS	255	XL - 10	510	£37.38 <sup>B</sup>

**New**

50 PAIRS

**9TH12**

**BOX OF 50 PAIRS OF NITRILE GLOVES**

- Gloves designed with a relief texture and a thickness of 8.5 mm for better protection and optimal handling.
- These gloves protect your hands from the risk of cuts, needle sticks and perforations during intensive work.
- These gloves are resistant to grease, gasoline and many chemicals.

Latex free. Powder free  
Compatible with touch screens.



EN ISO 374-1:2016 + A1:2018 Type B, EN ISO 374-5:2016, EN21420

Length (mm) Size

9TH12AL	237	L / 9	0.978	£13.80 <sup>B</sup>
9TH12AXL	245	XL - 10	1.026	£13.80 <sup>B</sup>



**79A2130** £12.02<sup>B</sup>



**79A2230** £12.46<sup>B</sup>

**RETRACTABLE TOOL LANYARD**

Reduces the risk of accidents related to falling tools. Maximum weight shown on a warning label. Nylon tether with a steel spring inside to absorb the shock of a dropped tool. Maximum load weight 3 kg.

Capacity mm Hook

79A2130	800~1300	2 lock snaps
79A2230	800~1300	1 lock snap & 1 fixed loop

**New**

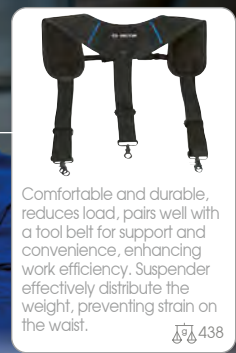

Comfortable and durable, reduces load, pairs well with a tool belt for support and convenience, enhancing work efficiency. Suspender effectively distribute the weight, preventing strain on the waist.

**8774002** £97.01<sup>B</sup>

**MULTI-FUNCTIONAL TOOL BELT POUCH**

600D Oxford fabric, durable, lightweight and waterproof, ideal for versatile use.



Padded utility belt with thick and breathable padding for a comfortable and security during work



45 mm diameter steel hammer ring.



Multi-pocket Tool Pouch : large storage capacity for various tools and parts, with more than 10 pockets for quick access, and a hook for tape measure.



Power tool holster pouch with five pockets for drills, screwdrivers and other tools, a side metal ring to hang small accessories, and a strap ensuring secure holding.

# WORKSHOP TOOLS



54 PC.



10 PC.

## 13954MQ kg 7.35 £711.11<sup>B</sup>

### TAP AND DIE SET

HSS steel. 3 Standard taps /Size (taper, second and bottoming).

Contents

	M3x2.5 M4x3.3 M5x4.2 M6x5.0 M8x6.8 M10x8.5	M12x10.2 M14x12.0 M16x14.0 M18x15.5 M20x17.5		20x5, 20x7, 25x9, 30x11, 38x14, 45x18
				1xN°1, 1xN°3



39 PC.

## 12939MQ1 kg 1.4 £105.91<sup>B</sup>

## 12939SQ1 kg 1.4 £112.14<sup>B</sup>

TAP AND DIE SET  
SK5 high carbon steel

Contents		
	M3x0.5 M3x0.6 M4x0.7 M4x0.75 M5x0.8 M5x0.9 M6x0.75 M6x1.0 M7x0.75	M7x1.0 M8x1.0 M8x1.25 M10x1.25 M10x1.5 M12x1.5 M12x1.75 1/8NPT27
	0.5, 0.6, 0.7, 0.75, 0.8, 0.9, 1.0, 1.25, 1.5, 1.75, 27, 28	
	4NS36 6NC32 8NC32 10NC24 10NF32 12NC24 1/4NC20 1/4NF28 5/16NC18	5/16NF24 3/8NC16 3/8NF24 7/16NC14 7/16NF20 1/2NC13 1/2NF20 1/8NPT27
	12, 13, 14, 16, 18, 20, 24, 27, 28, 32, 36, 40	

## 11310SQ kg 350 £32.93<sup>B</sup>

DRILL BIT AND STUD EXTRACTOR SET  
HSS steel

Contents

	2.5, 3, 4.5, 6, 8
	M3-6, M6-8, M8-11, M11-14, M14-18



28 PC.

## 11328SQ kg 960 £105.91<sup>B</sup>

DRILL BIT AND TAP SET  
HSS steel  
3 Standard taps /Size (taper, second and bottoming)

Contents

	2.5, 3.3, 4.2, 5, 6.8, 8.5, 10.2
	M3, M4, M5, M6, M8, M10, M12



## 3912M

### RATCHET BIT-HOLDER

- For use with a ratchet or T-handle.
- For taps



KT NO.	mm	Tap capacity	Ø mm	kg	£
39122008MD	1/4"	M3~M8	2.5 ~ 5	52	£14.06 <sup>B</sup>
39123010MD	3/8"	M1~M10	2 ~ 6	221	£18.25 <sup>B</sup>
39123012MD	3/8"	M5~M14	4 ~ 9	223	£18.69 <sup>B</sup>
39124012MD	1/2"	M10~M20	6 ~ 12	259	£19.58 <sup>B</sup>
39124016MD	1/2"	M20~M27	12 ~ 17	280	£28.48 <sup>B</sup>



4 PC.

## 39104M kg 0.98 £77.43<sup>B</sup>

### RATCHET BIT-HOLDER SET

Contents	mm	Tap capacity	Ø mm
39122008MD	1/4"	M3~M8	2.5 ~ 5
39123010MD	3/8"	M1~M10	2 ~ 6
39124012MD	1/2"	M10~M20	6 ~ 12
39124016MD	1/2"	M20~M27	12 ~ 17

5 YEARS WARRANTY

- + S45C steel interchangeable jaws
- + Firm holding of the part without damaging it



- + Faster opening/closing

- + Vice made entirely from steel.



Large anvil.



Pipe-clamp jaws.

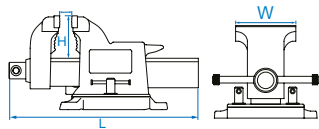

### 9TZ11

#### ROTATING BASE VICES

	mm	W mm	H mm	L mm	kg	
9TZ1104	146	104	57	310	7.50	£117.48 <sup>D</sup>
9TZ1105	166	130	67	365	11.0	£141.51 <sup>D</sup>
9TZ1106	200	155	76	422	14.5	£179.78 <sup>D</sup>
9TZ1108	225	200	89	492	18.0	£228.73 <sup>D</sup>
9TZ1110	250	250	102	572	25.6	£360.45 <sup>D</sup>

Suitable for stainless steel, hardened steel, mild steel, copper, brass, wood, fiberglass and hard plastic.



ø 13 - 35 mm



**338A2135** £60.52<sup>B</sup>

#### EXTERNAL DEBURRING AND CHAMFERING TOOL FOR DRILL/DRIVER

Designed to repair damaged wheel studs, bolts and deburred metal rods.

162



ø 3 - 19 mm



**338A1119** £22.25<sup>B</sup>

#### EXTERNAL DEBURRING AND CHAMFERING TOOL FOR 1/4" SCREWDRIVER

Designed to remove burr from round bars, threaded rods, screws, tubes and similar components. Maximum speed from 0 up to 400 rpm. Cutting insert material: high-speed steel (HSS).

66

New

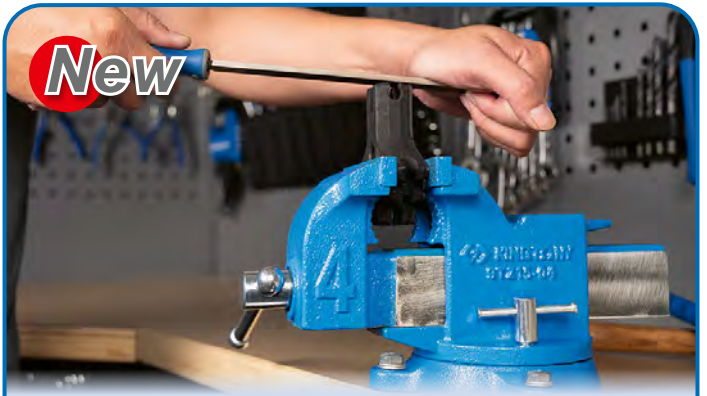

5 YEARS WARRANTY

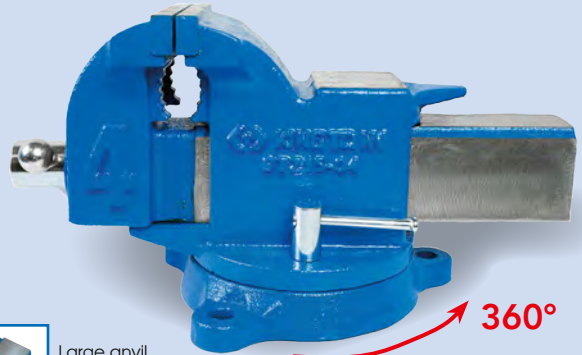

Large anvil.



Pipe-clamp jaws.



Serrated jaws design provides good grip.

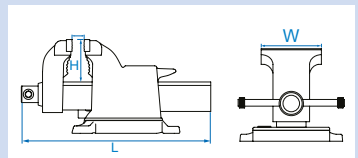

### 9TZ15

#### ROTATING BASE VICES

- Cast steel body and slide ideal for heavy duty applications.
- 360° swivel base.

	mm	inch	W mm	H mm	L mm	kg	
9TZ1504	100	4"	100	54	286	7.5	£70.31 <sup>D</sup>
9TZ1505	125	5"	125	64	307	12	£113.03 <sup>D</sup>
9TZ1506	150	6"	150	68	342	15.2	£129.05 <sup>D</sup>
9TZ1508	200	8"	200	85	430	20.3	£168.21 <sup>D</sup>

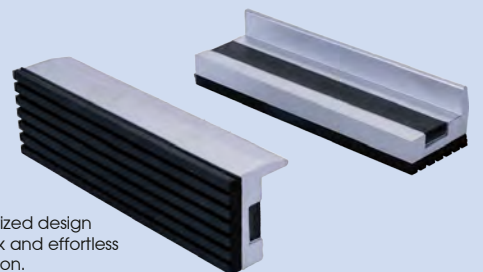

Magnetized design for quick and effortless installation.



Aluminium base  
Rubber coating  
Jaws protection for vice



### 9TZ10

#### PAIR OF PROTECTIVE JAWS

- Allows tightening of sensitive parts such as aluminum, copper, etc.
- The embossed rubber support surface ensures a non-slip grip and optimal protection of the goods.

	inch	W mm	H mm	kg	
9TZ104	4"	104	190	£13.35 <sup>B</sup>	
9TZ105	5"	130	237	£16.02 <sup>B</sup>	
9TZ106	6"	155	286	£19.58 <sup>B</sup>	
9TZ108	8"	200	379	£23.14 <sup>B</sup>	
9TZ110	10"	250	480	£28.48 <sup>B</sup>	



366

**74A00**

£24.03<sup>B</sup>

**REVOLVING PUNCH PLIER**

Six interchangeable punches:  
2.0 / 2.5 / 3.0 / 3.5 / 4.0 / 4.5 mm.



45°  
90°  
135°  
180°

300 mm

555



Internal spare blade storage.

**792112**

£17.80<sup>B</sup>

**HIGH PERFORMANCE HACKSAW**



164

**75RF09M**

£38.27<sup>B</sup>

**THREAD REPAIR FILE**

- For the restoration of defective internal and external threads
- Suitable for right and left-handed thread
- Suitable for metric pitch: 0,80 - 1,00 - 1,25 - 1,50 - 1,75 - 2,00 - 2,50 - 3,00

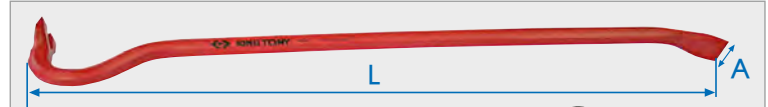

**79410**

**PRY BAR**

Drop forged and treated C40 steel. Flat and crowbar end. Red lacquer finish.

	A mm	B mm	C mm	D mm	L mm		
<b>7941060</b>	27	34	6	18	600	1425	£19.05 <sup>B</sup>
<b>7941080</b>	28	38	10	18	800	1875	£22.25 <sup>B</sup>



5 PC.

250 mm

**1015GQ**

£49.84<sup>B</sup>

**SECOND-CUT FILE SET**

Contents

1.2

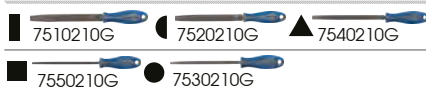

Ceramic burner head

adjustable flame

Aluminum body

122 x 70 x 168 mm

400



241



**6BB11**

£57.85<sup>B</sup>

**MINI BUTANE TORCH**

Type of gas : butane (not included).  
Gas reservoir : 34 ml.  
Maximum temperature : 1300°C / 2050°F.  
Anti-flare system allowing the device to be used at 360°.

**6BJ21**

£56.07<sup>B</sup>

**CORDLESS BUTANE GAS GLUE GUN**

Wireless, it is easily transportable and practical to use. 2 glue sticks of Ø 11 mm included. Butane not included.



814

**7CA8130H**

£31.15<sup>B</sup>

**HIGH THRUST CAULKUNG GUN**

Suitable for 310 ml cartridges.  
Professional caulk gun with 26:1 high thrust ratio.  
Easy and fast to replace the cartridges.  
450kgs maximum thrust power, perfect for applying thicker materials, adhesives.  
Application: glass, windowsill, bathroom, etc.



965

**7CA8230**

£34.71<sup>B</sup>

**HIGH THRUST ALUMINUM TUBE CAULKUNG GUN**

Suitable for 310 ml cartridges.  
Professional caulk gun with 18:1 high thrust ratio.  
Includes nozzle and pad.  
350kgs maximum thrust power, perfect for applying thicker materials, adhesives.  
Application: glass, windowsill, bathroom, etc.





**74020** £15.13<sup>B</sup>

**AVIATION TIN SNIPS**

- Right cut.
- Cutting length: 35 mm.
- Blades with serrated edges.
- Solid and comfortable handle with non-slip design.
- High strength torsion spring designed for longer life.

Cutting Capacities	
Copper: 1.5 mm	Hard Steel (HRC 30): 0.80 mm
Cold-rolled Steel: 1.20 mm	Stainless Steel: 0.70 mm



**74060** £19.58<sup>B</sup>

**AVIATION TIN SNIPS**

- Long straight cut.
- Cutting length 75 mm.
- Blades with serrated edges.
- Solid and comfortable handle with non-slip design.
- High strength torsion spring designed for longer life.

Cutting Capacities	
Copper: 1.1 mm	Hard Steel (HRC 30): 0.70 mm
Cold-rolled Steel: 0.94 mm	Stainless Steel: 0.53 mm



**74260** £17.80<sup>B</sup>

**FIGURE TIN SNIPS**

- Right cut.
- Cutting length: 35 mm.
- Blades with serrated edges.
- Solid and comfortable handle with non-slip design.
- High strength torsion spring designed for longer life.

Cutting Capacities	
Copper: 1.80 mm	Hard Steel (HRC 30): 1 mm
Cold-rolled Steel: 1.50 mm	Stainless Steel: 0.90 mm



**74270** £17.80<sup>B</sup>

**FIGURE TIN SNIPS**

- Straight cut.
- Cutting length: 35 mm.
- Blades with serrated edges.
- Solid and comfortable handle with non-slip design.
- High strength torsion spring designed for longer life.

Cutting Capacities	
Copper: 1.80 mm	Hard Steel (HRC 30): 1 mm
Cold-rolled Steel: 1.50 mm	Stainless Steel: 0.90 mm



**DCJ330** £140.62<sup>D</sup>

**HOLLOW PUNCHES**

Contents		1.13
DCJ	Ø3, Ø4, Ø6, Ø8, Ø10, Ø12, Ø14, Ø16, Ø18, Ø20, Ø22, Ø24, Ø26, Ø28, Ø30	



**DCJ250** £299.04<sup>D</sup>

**HOLLOW PUNCHES**

Retractable centering tip.

Contents		2.60
DCJ	Ø2, Ø3, Ø4, Ø5, Ø6, Ø7, Ø8, Ø9, Ø10, Ø12, Ø14, Ø16, Ø18, Ø20, Ø22, Ø24, Ø26, Ø28, Ø30, Ø32, Ø34, Ø36, Ø38, Ø40, Ø42, Ø44, Ø46, Ø48, Ø50	

**MEASURING TOOLS**



**79063**

**INOX FLEXIBLE STAINLESS RULE**

Double graduation metric (front) and imperial (back)

	A mm	E mm	L mm	g	
7906306	14.7	0.6	150	12	£1.34 <sup>B</sup>
7906312	23.7	1	300	65	£4.45 <sup>B</sup>
7906320	28.5	1.2	500	145	£10.59 <sup>B</sup>
7906340	35	1.2	1000	360	£17.80 <sup>B</sup>



**79094M**

**MEASURING TAPE**

EU Class II accuracy standard approval. Tape automatically locks. Resistant. Non-slip. Anti-reflective tape.

Measurement in metric		
7909402M	2 m x 16 mm	£5.52 <sup>B</sup>
7909403M	3 m x 16 mm	£6.59 <sup>B</sup>
7909405M	5 m x 19 mm	£8.90 <sup>B</sup>
7909408M	8 m x 25 mm	£14.42 <sup>B</sup>



**7909505M** £6.50<sup>B</sup>

**LIGHT & COMPACT MEASURING TAPE**

EU Class II accuracy standard approval. Measurement in metric. Nylon coating. Ergonomic & shockproof ABS+TPE case.

**New**

Available in April



Equipped with built-in graduations, it allows to measure and draw lines with precision.

200 mm



200 x 21.2 x 49 mm  $\Delta$  169

**7742108** £7.12 <sup>B</sup>

600 mm



600 x 24.2 x 63.3 mm  $\Delta$  556

**7743124** £16.91 <sup>B</sup>

**SPIRIT LEVELS**

- Made of high-quality aluminum, this level offers both lightness and robustness.
- Application environments: construction industry, woodworking, plumbing and electrical work, and automation equipment.
- With an accuracy of 0.5 mm/m (0.029°), it guarantees accurate measurements on all your sites.
- Its shock-absorbing tips ensure excellent impact resistance and extend the tool's lifespan.
- Thanks to its magnetic base, it can be used hands-free on metal surfaces for more comfort and efficiency.
- Its integrated handle offers high practicality during use.
- Easy to hang, it always remains within reach and simple to find.



**New**



**7713306** £44.50 <sup>B</sup>

**MANUAL VERNIER GAUGE**  $\Delta$  282

Stainless steel matte finish. Inside and outside measurement, depth gauge. Locking screw. Bevelled scale to reduce parallax effect.

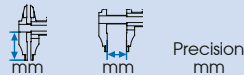

**7713306** 40 150 0.02

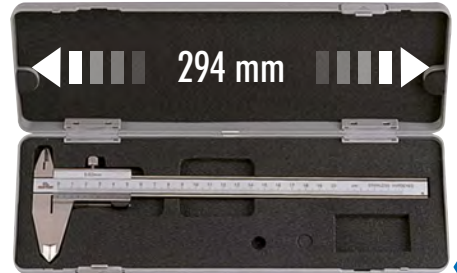

**7713308** £62.30 <sup>B</sup>

**MANUAL VERNIER GAUGE**  $\Delta$  400

Stainless steel matte finish. Inside and outside measurement, depth gauge. Locking screw. Bevelled scale to reduce parallax effect.

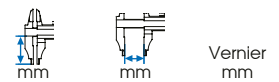

**7713308** 50 200 0.02



**7734020** £9.79 <sup>B</sup>

**20 BLADES METRIC FEELER GAUGE**  $\Delta$  105

Blade material : stainless steel.  
Shank thickness : 0.05 to 1.00 mm.



**77142061** £44.50 <sup>B</sup>

**DIGITAL VERNIER GAUGE**  $\Delta$  160

Locking by screw, precision adjustment knob. Digital screen. Printer output. Reset Functions. Metric Conversion to Inch.

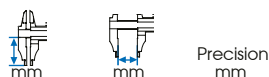

**77142061** 40 150 0.01



**77142081** £66.75 <sup>B</sup>

**DIGITAL VERNIER GAUGE**  $\Delta$  485

Locking by screw, precision adjustment knob. Digital screen. Printer output. Reset Functions. Metric Conversion to Inch.

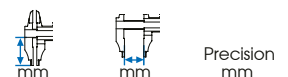

**77142081** 50 200 0.01



# LIGHTING

## INSPECTION LAMPS

525 mm

LIMITED QUANTITY

1.2kg

175 mm

360°

6000 K

1 W

100 Lumen

**79834A** £25.81<sup>B</sup>

**New** Available in February

172 mm

6500 K

3 W

300 Lumen

180°

**9TA282A** £19.14<sup>B</sup>

62471 EYE SAFETY

9TA271

Photobiological safety. Even illumination without hotspots.

Other brands  
Flickering & uneven illumination with harmful hotspots.

260 mm

6500 K

3 W

600 Lumen

180°

**9TA271** £29.37<sup>B</sup>

	Brightness	Color temperature	Dimensions	Battery life	Charging time	Li-on battery	USB	Ingress Protection	Weight
79834A	30 / 100 lm	6000 K	21 x 175 / 525 mm	2 ~ 6 h	2.5 h	3.7V - 180 mAh	◀ USB-C	IP65, IK09	89
9TA282A	COB: 300 lm, SMD: 120 lm	6500 K	L : 172 mm	2 ~ 3.5 h	2 h	3.7 V - 800 mAh	◀ USB-C	IP54, IK07	130
9TA271	COB: 250 / 600, SMD: 120 lm	6500 K	L : 260 mm	3 ~ 12 h	3.5 h	3.7 V - 2600 mAh	◀ USB-C	IP54, IK07, EN62471	186
9TA56A	30 / 60 / 170 lm	5700 K	210 x 225 mm	2 ~ 6 h	2 h	3.7 V - 250 mAh	◀ USB-A	IP20, IK07	100
9TA561A	30 / 60 / 170 lm	5700 K	210 x 225 mm	2 ~ 6 h	2 h	3.7 V - 250 mAh	◀ USB-A	IP20, IK07	120
9TA522A	200 / 400 lm	6500 K	L : 60 mm	2 ~ 4 h	2.5 h	3.7 V - 1500 mAh	◀ USB-C	IP54, IK07, EN62471	110

Usb (Powerbank output) : ▶ Usb (input) : ◀

210 mm

225 mm

5700 K

170 Lumen

100% ACRYLIC

5700 K

170 Lumen

100% ACRYLIC

**9TA56A** £14.24<sup>B</sup>

**9TA561A** £19.58<sup>B</sup>

**New**

10 cm INTELLIGENT MOTION SENSOR

Power switch

Charging indicator

Inductive indicator

Type-C charger port

65 mm

60°

Up to 4 adjustable tilt angles for personalized comfort (up to 60°).

Phosphorescent material for quick visibility in the dark.

62471 EYE SAFETY

6500 K

4 W

400 Lumen

**9TA522A** £39.16<sup>B</sup>

**LIMITED QUANTITY**



6500 K  
7 W  
**700**  
Lumen

**LIMITED QUANTITY**

305 mm

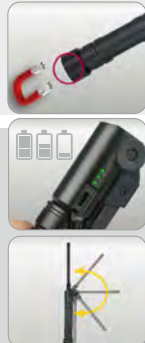

**AI<sup>13</sup>**  
ALUMINIUM  
6500 K  
8 W  
**800**  
Lumen

**LIMITED QUANTITY**

400 mm

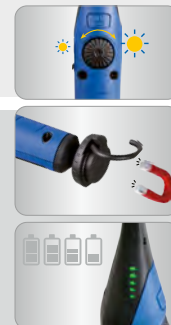

**DIMMABLE**  
+/- 6500 K  
7 W  
**700**  
Lumen

**9TA242AA** £61.41<sup>B</sup>

**9TA268AA** £59.63<sup>B</sup>

**9TA262AA** £67.64<sup>B</sup>

	Brightness	Color temperature	Dimensions	Battery life	Charging time	Li-on battery	USB	Ingress Protection	⚖️
<b>9TA242AA</b>	COB: 150 / 350 / 700, SMD: 200 lm	6500 K	L: 260 mm	2 ~ 8 h	4 h	3.7 V - 2600 mAh	◀ USB-C	IP65, IK07	396
<b>9TA268AA</b>	COB: 120 - 150 / 800 - SMD: 120 / 400 lm	6500 K	L: 162 / 303 mm	COB: 2,5 ~ 8 h - SMD: 4 ~ 9 h	4 h	3.7 V - 2600 mAh	◀ USB-C	IP54, IK07	193
<b>9TA262AA</b>	COB: 700 - SMD: 120 lm	6000 K - 7000 K	L: 385 mm	2 ~ 15 h	4 h	3.7 V - 2600 mAh	◀ USB-C	IP54, IK07	300
<b>9TA54A</b>	180 / 350 lm	6500 K	230 x 130 x 45 mm	2.2 ~ 5.5 h	2.5 h	3.7 V - 700 mAh	◀ USB-C	IP54, IK07	140
<b>9TA44W</b>	COB: 160 / 400 / 800 - SMD: 250 lm	6500 K	97 x 83 x 39 mm	2.5 ~ 10 h	4 h	3.7 V - 2600 mAh	◀ USB-C	IP65, IK07	218

Usb (Powerbank output) : ▶ Usb (Input) : ◀



+/- 6500 K  
3,5 W  
**350**  
Lumen

**9TA54A** £48.06<sup>B</sup>



WIRELESS CHARGING DESIGN\*  
\*inductive charger not included

**LIMITED QUANTITY**



97 mm

6500 K  
8 W  
**800**  
Lumen

**9TA44W** £55.18<sup>B</sup>



FLOODLIGHTS



LIMITED QUANTITY

LIMITED QUANTITY

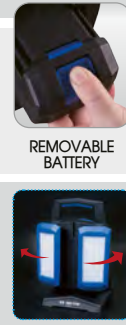

**9TA48AA** £114.81<sup>B</sup>

**9TA46AA** £188.68<sup>B</sup>

**9TA45AA** £177.11<sup>B</sup>

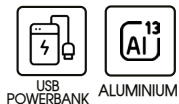

6500 K  
30 W  
**3000 Lumen**



6500 K  
40 W  
**4000 Lumen**



5700 K  
45 W  
**4500 Lumen**

	Brightness	Color temperature	Dimensions	Battery life	Charging time	Li-on battery	USB	Ingress Protection	⚖️
9TA48AA	300 / 750 / 1500 / 2250 / 3000 lm	6500 K	205 x 153 x 75 mm	3 ~ 25 h	4.5 h	7.4 V - 5200 mAh	◀ USB-A USB-C ▶	IP65, IK07	960
9TA46AA	400 / 4000 lm	6500 K	210 x 210 x 100 mm	3.5 ~ 12 h	3.5 h	11.1 V - 5200 mAh	USB-A ▶	IP65, IK07	1450
9TA45AA	750 / 1500 / 3000 / 4500 lm	5700 K	288 x 176 x 131 mm	2 ~ 12 h	4.5 h	14.8 V - 5200 mAh	USB-A ▶	IP54, IK07	2140
9TA491AA	600 / 1200 / 2400 / 6000 lm	2700 - 6500 K	142 x 142 x 1200 mm	2 ~ 16 h	4.5 h	14.8 V - 5200 mAh	◀ Charging cable	IP65, IK07	4400

Usb (Powerbank output) : ▶ Usb (input) : ◀

1500 mm  
700 mm  
3 kg

**87162KA** £34.71<sup>B</sup>

**9TA48AA** x2  
**87162KA**

**9TA48AZ** £257.21<sup>B</sup>

**9TA421AA**  
**87162KA**

**9TA421AZ** £100.57<sup>B</sup>

90°  
330°

2700 K  
3500 K  
4500 K  
5500 K  
6500 K

60 W  
**6000 Lumen**

**9TA491AA** £239.41<sup>B</sup>



**9TA421AA** £70.31<sup>B</sup>

**LIMITED QUANTITY**

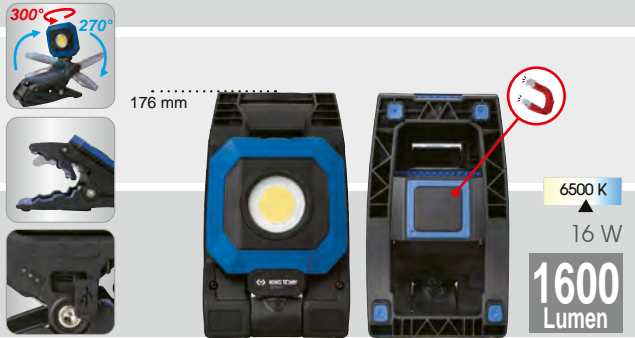

**9TA471A** £72.98<sup>B</sup>

	Brightness	Color temperature	Dimensions	Battery life	Charging time	Li-on battery	USB	Ingress Protection	⚖️
9TA421AA	1500 / 3000 lm	6500 K	240 x 270 x 55 mm					IP54, IK08	1393
9TA471A	100 / 300 / 700 / 1600 lm	6500 K	176 x 105 x 95 mm	3 ~ 24 h	5 h	3.7 V - 5200 mAh	◀ USB-C	IP65, IK07	625
9TA33AA	400/1000 lm	6500 K	L : 500 mm	2.2 ~ 5.5 h	4.5 h	7.4 V - 2600 mAh	◀ USB-C	IP20, IK07	487
9TA34AA	500/1000/2000 lm	6500 K	L : 1170 ~ 1900 mm	2 ~ 6.5 h	4 h	3.6 V - 4800 mAh	◀ USB-C	IP20, IK07	1110

Usb (Powerbank output) ▶ Usb (input) : ◀

## UNDER HOOD WORK LIGHTS

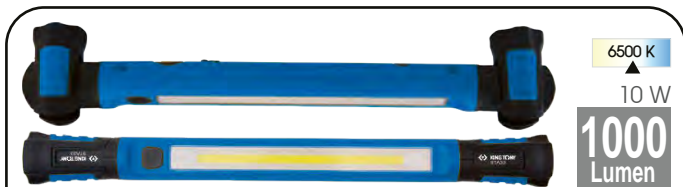

**9TA33AA** £53.40<sup>B</sup>



**9TA34AA** £121.93<sup>B</sup>

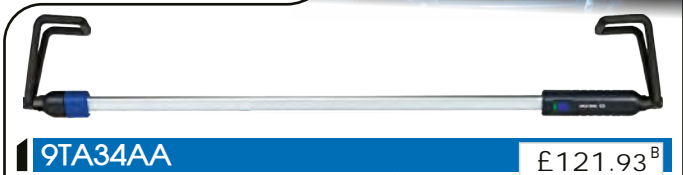

**9TA34P01A** £28.48<sup>B</sup>

**3.6 V, 4800 MAH LI-ION RECHARGEABLE BATTERY**

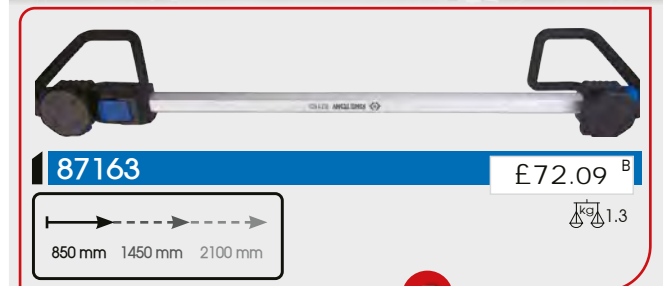

**87163** £72.09<sup>B</sup>

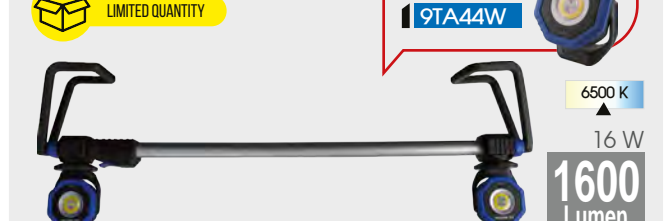

**9TA44W** £179.78<sup>B</sup>

**9TA44AZ** £179.78<sup>B</sup>

Contents

- 9TA44W x2
- 87163

**WIRELESS CHARGING DESIGN\***  
\*inductive charger not included

# STORAGE AND TOOL SETS

## PORTABLE STORAGE



**87A09A** £5.87<sup>B</sup>

### PORTABLE TOOL TRAY

Deep tray with tool slots. The combination of PP and aluminum handle makes the product lightweight yet sturdy, offering excellent structural strength and durability. Equipped with secure bit slots and multiple compartments, tools stay organized and do not fall out.

912



Tray features 7 slots for 1/4" screwdriver bits, ensuring stability on the inside and safe, easy access.



The curved storage compartment securely holds small parts for easy access



Can be placed inside your workstation cabinet, providing efficient storage and quick access to tools



Metal handle for easy carrying



Empty trays can be stacked to save space

## MODULAR STACKING BOX M6 BOX



**S** | **874051** 15kg £55.18<sup>D</sup>

456 x 372 x 115 mm

**M** | **874052** 15kg £61.41<sup>D</sup>

456 x 372 x 155 mm

**L** | **874053** 15kg £73.87<sup>D</sup>

456 x 372 x 262 mm

**874059** 90kg £67.64<sup>D</sup>

655 x 490 x 170 mm

### ROLLER SUPPORT



**9052002MRV** £417.41<sup>D</sup>

### TOOL BOX «THE ESSENTIALS»

Contents

10.46

2335M	4, 4.5, 5, 5.5, 6, 7, 8, 9, 10, 11, 12, 13, 14			
4335M	10, 13, 15, 16, 17, 18, 19, 20, 21, 22, 24, 27, 30, 32			
275955G	477310GS	2179DF	2142	
425110R	2792	4791	75363	770225
1145MR	H1.5, H2, H2.5, H3, H4, H5, H6, H8, H10	20002UB		
1147R	T10H, T15H, T20H, T25H, T27H, T30H, T40H, T45H, T50H			
1025H	H3, H4, H5, H6	1025P	PH1, PH2 x 2, PH3	
1025S	3.0, 4.0, 5.0, 6.0			
1025T	T10, T15, T20, T25, T27, T30, T40			
1025U	T10H, T15H, T20H, T25H, T27H, T30H, T40H			
1025Z	PZ1, PZ2 x 2, PZ3			
Ø 4 x 120	15 x 125	3 x 120		
Ø 4 x 150	5 x 130	782130OS		
1062	8, 9, 10, 11, 12, 13, 14, 16, 17, 18, 19, 22	361110R		
631108	651110	621106	611107	
6AB3175	9TA281	7909505M	874052	

112 PC.



\*The guarantee is unlimited in time, excludes impact tools, toolbox and 1/4" screw bits.

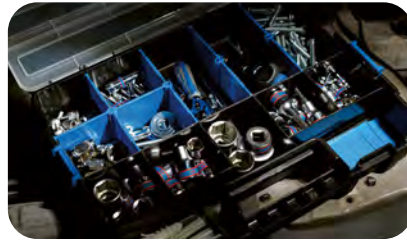

**8714101B**

£16.55 <sup>B</sup>

**PORTABLE STORAGE CASE**

With removable dividers to create compartments of different sizes according to your needs.  
The see-through lid makes it easy to find the parts you need.  
Stackable design.  
Long lasting material to protect parts during transport.

0.79

376 x 290 x 67 mm

**87723B**

£70.31 <sup>B</sup>

**MULTI-USE BACKPACK**

14 POCKETS

20 kg



Wide opening for easy tool access.



600 denier Oxford waterproof fabric



PVC base



Back with honeycomb pads absorb vibrations and increase ventilation.



Adjustable chest strap



Velcro strap in the back, designed to secure the bag on a suitcase.

1.6

Tools pictured are not included.

600 denier Oxford waterproof fabric



Comfortable handle  
Aluminum handle fixed with 4 rivets

39 POCKETS

PP molded tool bag bottom

510 x 345 x 260 mm

3.0



Tools pictured are not included.

**87711C**

£88.11 <sup>B</sup>

**FABRIC TOOL BAG**

50% lighter than a metal toolbox.  
Wide bulk section with elastic strap for screwdrivers.  
Special hacksaw pocket.  
Equipped with 39 storage pockets.  
Riveted assembly.  
Top flap folds away into a pocket.  
Cushioned shoulder strap with steel fixture.  
Delivered without tools.

**BASIC**  
series



2.2

**BASIC**  
series

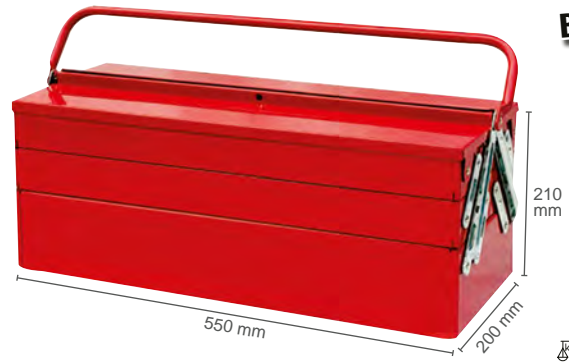

5.3

**87A03AUS**

£18.69<sup>D</sup>

**METAL TOOL BOX**  
1 COMPARTMENT WITH TRAY



**87A02AUS**

£47.17<sup>D</sup>

**METAL TOOL BOX**  
5 COMPARTMENTS ON 3 LEVELS

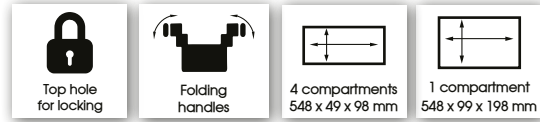

**87A08**

£32.93<sup>D</sup>

**PLASTIC AND METAL TOOL BOX**

PP Reinforced shockproof shell.

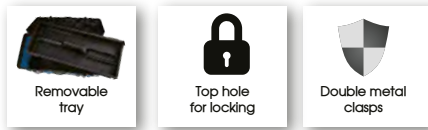

2.0



**BASIC**  
series



**87A05A0KB**

£47.17<sup>D</sup>

**87A05A0KG**

£47.17<sup>D</sup>

**BASIC METAL TOOLBOX**

Overall dimensions: 470 x 220 x 260mm



5.1

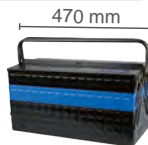

**87A051A0KB**

**XL**

£51.62<sup>D</sup>

**87A051A0KG**

**XL**

£51.62<sup>D</sup>

**BASIC XL METAL TOOLBOX**

Overall dimensions: 530 x 220 x 260mm



5.5



**STRENGTH**  
series

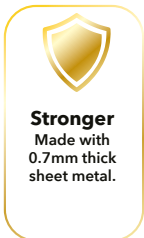

**87402**

£79.21<sup>D</sup>

**STRENGTH METAL TOOLBOX**

Overall dimensions: 470 x 220 x 260mm



5.6



**87408**

**XL**

£103.24<sup>D</sup>

**STRENGTH XL METAL TOOLBOX**

Overall dimensions: 530 x 220 x 260mm



6.7



LIFETIME GUARANTEE\*



128  
PC.



1/2"

42  
PC.

**415147ELC1**

£507.30<sup>D</sup>

Electromechanical version.

Contents

9.08

	87404		
	2335M	4, 4.5, 5, 5.5, 6, 7, 8, 9, 10, 11, 12, 13	
	1062	5.5, 6, 7, 8, 9, 10, 11, 12, 13, 14, 16, 17, 18, 19	
	1422	3 x 75, 4 x 100, 5.5 x 125, 6.5 x 150, 8 x 175	
	1421	PH1 x 80, PH2 x 100	
	2221	55, 150 mm	
	2759G	2178DF	2792
	6CB02	6BC141	2141
	1025P	PH1, PH2, PH3	
	1025Z	PZ1, PZ2, PZ3	
	1025S	4, 6.5, 7, 8	
	1025U	T8H, T9H, T10H, T15H, T20H, T25H, T27H, T30H, T40H	
	1025H	2.5, 3, 4, 5, 6, 7, 8, 10	
	1472	4 x 100	
	2121	6314	6214
	6BD11	6AB1255	6BF1125
	1431	PH000 x 75, PH00 x 75, PH0 x 75, PH1 x 75	
	1432	1.5 x 75, 2.0 x 75, 2.5 x 75, 3.0 x 75	
	1125M	H1.5, H2, H2.5, H3, H4, H5, H6, H8, H10	
	761	Ø3	
	764	Ø2, Ø3.4, Ø4, Ø5	
	7842_PAH		
	7951212	675144	
	79093M	7734020	
	6116A	6216A	
	6318A	6516A	
	45115PP		
	1036ZQ		

**41542MRV**

1/2"

£194.91<sup>B</sup>

Contents

6.2

	4335M	10, 11, 13, 14, 15, 16, 17, 18, 19, 21, 22, 24	
	1062	8, 9, 10, 11, 12, 13, 14, 17, 18, 19, 22, 24	
	1422	3 x 75, 5.5 x 125, 6.5 x 150	
	1421	PH0 x 60, PH1 x 80, PH2 x 100	
	1130M	H2.5, H3, H4, H5, H6, H8, H10	
	477110G	425105	4791
	361108R	611106	87A08



**902A026MR**

26  
PC.

£168.21<sup>D</sup>

Contents

6.04

	1060	8, 10, 12, 13, 14, 17, 19, 21, 22, 24	
	1422	3 x 75, 4 x 100, 5.5 x 125, 6.5 x 150, 8 x 175	
	1421	PH1 x 80, PH2 x 100	
	764	Ø2 x 30, Ø3 x 40, Ø4 x 50, Ø5 x 50, Ø6 x 50, Ø8 x 50	
	651610C	361112R	
	786238	87A03AUS	

**902A039MR 1/2"**

39  
PC.

£218.05<sup>D</sup>

Contents

7.59

	4335M	8, 10, 11, 12, 13, 14, 15, 16, 17, 18, 19	
	477110G	425106	

+13

\*The guarantee is unlimited in time, excludes tape measure, hacksaw blade, striking tools, toolbox and 1/4" screw bits.

Non-contractual photographs. Offer valid from 01/01/2026 to 31/12/2026. Recommended retail prices in pounds excl. taxes.



**STRENGTH**  
series

1/2"

470 x 220 x 260 mm

902076MR

902091MR

902089MR03

902103MR07

902083MR

902098MR1

**902076MR** 1/2" **76** PC. £351.55<sup>D</sup>

+12 **902089MR03** **88** PC. £488.61<sup>D</sup>

+7 **902083MR** **83** PC. £457.46<sup>D</sup>

Contents 17.70

**902091MR** 1/2" **91** PC. £515.31<sup>D</sup>

+12 **902103MR07** **103** PC. £622.11<sup>D</sup>

+7 **902098MR1** **98** PC. £586.51<sup>D</sup>

Contents 24.8

	4335M	10, 11, 12, 13, 14, 15, 16, 17, 18, 19, 20, 21, 22, 23, 24, 27, 30, 32
	475910G	4791
	463521R	425105, 425110
	457212	445218F
	422302	
	1062	6, 7, 8, 9, 10, 11, 12, 13, 14, 15, 16, 17, 18, 19, 20, 21, 22, 24
	1900	6 x 7, 8 x 10, 11 x 13, 12 x 13, 17x19, 22 x 24
	1120MR	H1.5, H2, H2.5, H3, H4, H5, H6, H8, H10
	1147	T10H, T15H, T20H, T25H, T27H, T30H, T40H
	1421	PH2 x 38, PH3 x 150
	1422	3 x 75, 5 x 100
	611107	631106
	651610C	
	782180	361108R
	791112	87402

	4335M	10, 11, 12, 13, 14, 15, 16, 17, 18, 19, 20, 21, 22, 23, 24, 27, 30, 32
	475910G	4791
	463521R	425105, 425110
	457212	445218F
	422302	
	1062	8, 9, 10, 11, 12, 13, 14, 15, 16, 17, 18, 19, 21, 22, 23, 24, 27, 30, 32
	1120MR	H1.5, H2, H2.5, H3, H4, H5, H6, H8, H10
	1147	T10H, T15H, T20H, T25H, T27H, T30H, T40H
	1421	PH0 x 60, PH1 x 100, PH2 x 100, PH3 x 150
	1422	3 x 75, 4 x 100, 5 x 75, 5.5 x 125, 6.5 x 150, 8 x 175
	611107	631106
	651610C	
	623208	643110
	601110R	
	782180	361112R
	791112	
	2x115, 3x125, 4x150, 5x165, 6x180, 8x200, 12x230, 14x250	
	20x175, 26x300	7909303C
	87402	

INCLUDED IN 902089MR03 / 902103MR07

Contents

1812MR

1080 8, 10, 11, 12, 13, 14, 16, 17, 18, 19, 22, 24

INCLUDED IN 902083MR / 902098MR1

Contents

Reversible

373A 8, 10, 11, 12, 13, 17, 19

122A07MRN01

\*The guarantee is unlimited in time, excludes tape measure, hacksaw blade, striking tools and toolbox.

LIFETIME GUARANTEE\*

902100MKB2 1/4" + 1/2" 100 PC. £408.51<sup>D</sup>

902100MG2 1/4" + 1/2" 100 PC. £408.51<sup>D</sup>

**BASIC**  
series



902100MKB2

902100MG2

1/4" 1/2"

Contents

13.17

2335M	4, 4.5, 5, 5.5, 6, 7, 8, 9, 10, 11, 12, 13
4335M	10, 11, 12, 13, 14, 15, 16, 17, 18, 19, 21, 22, 24
277155G	477910G
222104	4791 2142
1421	PH1x80, PH2x100, PH3x150
1422	5.5x100, 6.5x150, 8.0x175
1062	8, 10, 11, 12, 13, 14, 15, 16, 17, 18, 19, 21, 22, 24
651710C	611107 621106
631106	797707 7909505M
9TA28A	87A05A0KB / 87A05A0KG
1120MR	H1.5, H2, H2.5, H3, H4, H5, H6, H8, H10
1025H	H3, H4, H5, H6
1025P	PH1, PH2, PH2, PH3
1025S	3, 4, 5, 6
1025Z	PZ1, PZ2, PZ2, PZ3
1025T	T10, T15, T20, T25, T27, T30, T40
1025U	T10H, T15H, T20H, T25H, T27H, T30H, T40H
425110	457212
75363	770225

908077MR01 1/2" + 3/4" 77 PC. £515.31<sup>D</sup>

Contents

26.5

4335M	7, 8, 9, 10, 11, 12, 13, 14, 15, 16, 17, 18, 19, 21, 22, 23, 24, 26, 27, 28, 30, 32
4025	H5, H6, H8, H10, H12, H14
463521R	
477910G	457212
425103, 425105, 425110	4791
6330M	33, 36, 38, 41, 46, 50
677920F	657220
625108, 625116	
1062	8, 10, 11, 12, 13, 14, 17, 18, 19, 21, 24, 27, 30, 32
1461	PH1 x 75, PH2 x 100, PH3 x 150
1462	5.5 x 100, 6.5 x 150, 8 x 175
1145M	H1.5, H2, H2.5, H3, H4, H5, H6, H8, H10
36110P	65110C



**XL** 87408

**STRENGTH**  
series

1/2" 3/4"



**STRENGTH**  
series



660 mm

307 mm

Central locking	0.8 mm thick sheet metal	side transportation handles	100% Drawers on ball bearing slides	Reinforced drawers
-----------------	--------------------------	-----------------------------	-------------------------------------	--------------------

874213B

£194.91<sup>D</sup>

TOOL CHEST

Specifications	Dimensions (mm)		13
	L	D x H	
874213B	Total	660 x 307 x 251	13
	2 Drawers	569 x 275 x 50	
	1 Drawer	569 x 275 x 75	



\*The guarantee is unlimited in time. excludes tape measure, cutter, penlight, hacksaw blade, impact tools, toolbox and 1/4" screw bits.

Non-contractual photographs. Offer valid from 01/01/2026 to 31/12/2026. Recommended retail prices in pounds excl. taxes.

**New**

Soft-close lid with two slow-descending hydraulic struts — for safe, smooth, and quiet operation

**SQUAD**

Integrated side handles for safe lifting and placement onto the roller cabinet



RFS (ON/OFF button): Opening of one drawer at a time to avoid tilting risks



Can be paired with a sturdy and reliable SQUAD roller cabinet using 2 side runners that slot into the cabinet

**87SQ114BANK**

£353.33<sup>D</sup>

**TOOL CHEST**

	Specifications	Dimensions L x D x H (mm)	
87SQ114BANK	Total	720x472x515	37.5
	4 Drawers	570x380x70	
	Top	650x460x120	

- Bumper
- RFS System anti-tip
- 300 kg
- Key central locking
- 30 kg
- 570x380 mm
- Reinforced drawers
- 100% Drawers on ball bearing slides

**STRENGTH series**

874116B



6 Drawers + 1 Top

874119B



9 Drawers + 1 Top



- Key central locking
- 0.8 mm thick sheet metal
- Removable tray
- 100% Drawers on ball bearing slides
- Reinforced drawers

**874116B** £316.84<sup>D</sup>

**874119B** £372.91<sup>D</sup>

**TOOL CHEST**

	Specifications	Dimensions (mm) L x D x H	
874116B	Total	660 x 307 x 374	25.4
	Top	646 x 290 x 60	
	3 Drawers	170 x 275 x 50	
	2 Drawers	569 x 275 x 50	
874119B	1 Drawer	569 x 275 x 75	30.2
	Total	660 x 307 x 427	
	Top	646 x 290 x 60	
	6 Drawers	170 x 275 x 50	
	2 Drawers	569 x 275 x 50	
	1 Drawer	569 x 275 x 75	



Dividers included



**STRENGTH XL series**

8741710BG



10 Drawers + 1 Top

874195B



5 Drawers + 1 Top

Gas spring



- #6 560 x 375 mm
- 1 mm thick sheet metal
- Key central locking
- 100% Drawers on ball bearing slides
- Reinforced drawers

**8741710BG** £568.71<sup>D</sup>

**874195B** £461.91<sup>D</sup>

**XL TOOL CHEST (EXTRA DEEP)**

	Specifications	Dimensions (mm) L x D x H	
8741710BG	Total	660 x 455 x 483	51.2
	Top	646 x 420 x 70	
	6 Drawers	169 x 410 x 48.5	
	1 Drawer	169 x 410 x 154	
874195B	2 Drawers	576 x 410 x 48.5	40
	1 Drawer	576 x 410 x 75	
	Total	660 x 455 x 483	
	Top	646 x 420 x 70	
	3 Drawers	576 x 410 x 75	
	2 Drawers	576 x 410 x 48.5	



**New**

LIFETIME GUARANTEE\*



**STRENGTH**  
series

- Key central locking
- 0.8 mm thick sheet metal
- Removable tray
- 100% Drawers on ball bearing slides
- Reinforced drawers

151 PC.

**911011MR**

£960.31<sup>D</sup>

COMPLETE TOOL CHEST



Specifications	Dimensions (mm) L x D x H		kg
	Total	660 x 307 x 374	
911011MR	Top	646 x 290 x 60	45.28
	3 Drawers	170 x 275 x 50	
	2 Drawers	569 x 275 x 50	
	1 Drawer	569 x 275 x 75	

Contents

	2235M	4, 4.5, 5, 5.5, 6, 7, 8, 9, 10, 11, 12, 13, 14		631108		623208		611108	
	2335M	4, 4.5, 5, 5.5, 6, 7, 8, 9, 10, 11, 12, 13, 14		66SS07		66SB07		66HS07	66HB07
	4335M	8, 10, 11, 12, 13, 14, 15, 16, 17, 18, 19, 20, 21, 22, 23, 24, 26, 27, 28, 30, 32		277355G		477310GS		2178	
	4375M	E10, E12, E14, E16, E18, E20, E22, E24		4023	T20, T27, T30, T40, T45, T50, T55, T60, T70		222102, 222104, 222106	425105, 425110	
	4025	3, 4, 5, 6, 7, 8, 10, 11, 12, 14, 17, 19		2792	2792	4791	429302	4813	6814
	1062	6, 7, 8, 9, 10, 11, 12, 13, 14, 15, 16, 17, 18, 19, 20, 21, 22, 24		257145			2142		601110
	1125M	H1.5, H2, H2.5, H3, H4, H5, H6, H8, H10					7640306, 7640406, 7640565, 7640607		7610405
	1123R	T10, T15, T20, T25, T27, T30, T40, T45, T50					7621706, 7622007		782130
	1421	PH1 x 80, PH2 x 100, PH3 x 150		874116B					
	1422	5.5 x 100, 6.5 x 150, 8 x 175							651710C

**911000CR07 1/4"+3/8"+1/2"** £1,059.10<sup>D</sup>

Metric and Imperial dimensions.



219 PC.

Contents

48.1

	2335M	4, 4.5, 5, 5.5, 6, 7, 8, 9, 10, 11, 12, 13		463516M, 463521R	
	2335S	5/32", 3/16", 7/32", 1/4", 9/32", 5/16", 11/32", 3/8", 7/16", 1/2"		2792	3792
	2235M	4, 5, 5.5, 6, 7, 8, 9, 10, 11, 12, 13		4791	
	2235S	5/32", 3/16", 7/32", 1/4", 9/32", 5/16", 11/32", 3/8", 7/16", 1/2"		322103, 322106	
	3330M	6, 7, 8, 9, 10, 11, 12, 13, 14, 15, 16, 17, 19, 20, 21, 22		345208F	
	3330S	3/8", 7/6", 1/2", 9/16", 5/8", 11/16", 3/4", 13/16"		357108	
	4330M	10, 11, 12, 13, 14, 15, 16, 17, 18, 19, 20, 21, 22, 23, 24, 27, 30, 32		425105, 425110	
	4330S	3/8", 7/16", 1/2", 9/16", 5/8", 11/16", 3/4", 13/16", 7/8", 15/16", 1"		445215F	
	1900	8 x 9, 10 x 11, 12 x 13, 14 x 15, 18 x 19		457210	
	5900	1/4"x5/16", 3/8"x7/16", 7/16"x1/2", 9/16"x5/8", 11/16"x3/4", 13/16"x7/8"		361108P, 361112P	
	1062	6, 7, 8, 9, 10, 11, 12, 13, 14, 15, 16, 17, 19, 20, 21		623107	631106
	5060	1/4", 5/16", 3/8", 7/16", 1/2", 9/16", 5/8", 11/16", 3/4", 13/16", 7/8", 1"		611107	651110C
	1970	6x7, 8x9, 10x11, 12x13, 14x15, 16x17, 18x19		68SB07	68SS07
	5970	1/4"x5/16", 3/8"x7/16", 1/2"x9/16", 5/8"x11/16", 3/4"x7/8", 15/16"x1", 1-1/16"x1-1/8"		68HS07	68HB07
	1930	10 x 11, 12 x 14, 14 x 17		601110	
	1120MR	H1.5, H2, H2.5, H3, H4, H5, H6, H8, H10		7640406, 7640607, 7640808	
	1130S	3/32", 1/8", 5/32", 3/16", 1/4", 5/16", 3/8"		7621505, 7621706, 7622007, 7622410	
	1421	PH0, PH1, PH2, PH3		7610506	
	1422	3x75, 6.5x38, 6.5 x 100, 6.5x150, 8x175		7811160S	
	277955G			791112	
	377908G			874116B	
	477910G				
	2813				
	3812				
	4813				
	222102, 222104				

\*The guarantee is unlimited in time, excludes striking tools and tool chest.

Non-contractual photographs. Offer valid from 01/01/2026 to 31/12/2026. Recommended retail prices in pounds excl. taxes.



KING TONY



## SMART STORAGE:

# WHICH TOOL TROLLEY IS MADE FOR YOU?

Professionals in industry, automotive, or agriculture, King Tony offers you a complete range of robust and modular workshop trolleys.

**Compact or extra-large tool trolleys, empty or equipped, with or without storage spaces:** our catalog offers a multitude of configurations to suit your profession and the way you work.



Reinforced tool trolleys for demanding environments.



RFS - Risk-Free System : anti-tip system for optimal security.



For safety: Key central locking.



Extra-large model for maximum capacity.



Tool trolleys equipped with King Tony tool sets.

**Organize, secure, and optimize** your workspace with a tool trolley designed for your business activity.

## WORKSHOP STORAGE

**BASIC**  
series

**6**

**DRAWERS**



Available in 3 colours



87G386BA 87G386BAB 87G386BAG

**87G386BA(-B/-G)**

£436.10<sup>D</sup>

**BASIC TOOL TROLLEY - 6 DRAWERS**

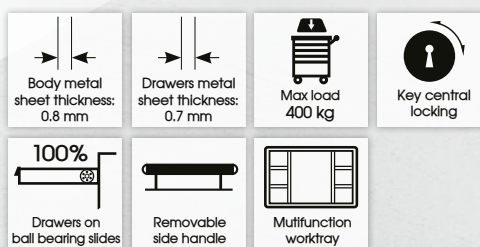

	Specifications		Dimensions (mm) L x D x H		kg
	87G386BA	Total excl. wheels	760 x 458 x 809	53.7	
	Total + Ø127x50 mm wheels	760 x 458 x 969			
	3 drawers	570 x 380 x 72			
	3 drawers	570 x 380 x 149.5			

**BASIC**  
series



**87G341A**

£29.37<sup>B</sup>

**SIDE TRAY**

Compatible with 87G386BA(-B/-G).

**PRO**  
series

**7**

**DRAWERS**



Available in 2 colours



ST874347B ST874347BPG

**ST874347B(-PG)**

£533.11<sup>D</sup>

**PRO TOOL TROLLEY - 7 DRAWERS**

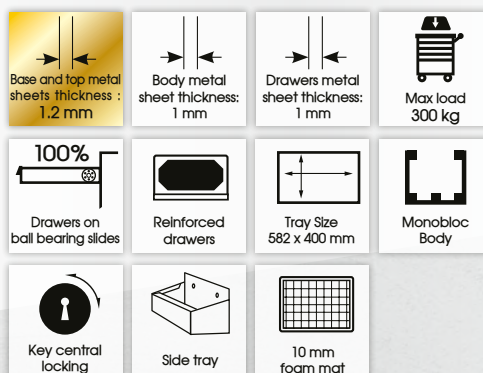

	Specifications		Dimensions (mm) L x D x H		kg
	ST874347B (-PG)	Total	680 x 460 x 823	64	
	Total + Ø127x32 mm wheels	680 x 460 x 953			
	5 drawers	582 x 400 x 76			
	2 drawers	582 x 400 x 156			

**STRENGTH**  
series

**5**  
DRAWERS



**874315BT**

£470.81<sup>D</sup>

**STRENGTH TOOL TROLLEY - 5 DRAWERS**

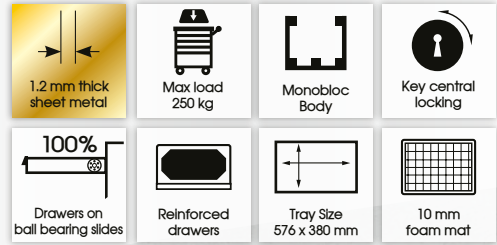

Specifications	Dimensions (mm) L x D x H		kg
	Total	670 x 460 x 654	
874315BT Total + 101x32 mm wheels	670 x 460 x 785		
3 drawers	576 x 380 x 75		
2 drawers	576 x 380 x 154		

Designed to be paired with Strength series workshop benches.

**STRENGTH**  
series

**BUMPER**  
series

**7**  
DRAWERS



**876347B(-B/-G)**

£800.11<sup>D</sup>

**BUMPER TOOL TROLLEY - 7 DRAWERS**

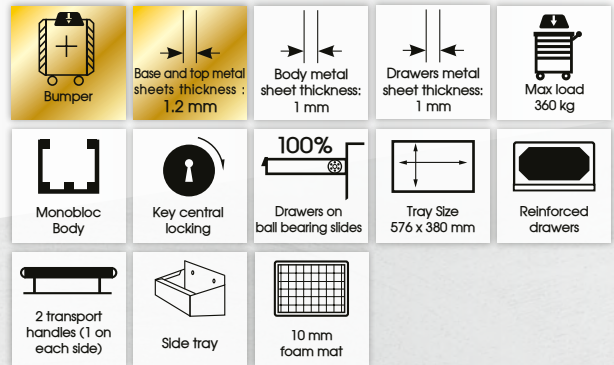

Specifications	Dimensions (mm) L x D x H		kg
	Total	820 x 475 x 775	
876347B Total + Ø127x32 mm wheels	820 x 475 x 940		
5 drawers	576 x 380 x 75		
2 drawers	576 x 380 x 154		

**BUMPER**  
**RFS** series

**8**  
DRAWERS



RFS - Risk-Free System :  
anti-tip system for  
optimal security.



**876348GG**

£889.11<sup>D</sup>

**BUMPER RFS TOOL TROLLEY - 8 DRAWERS**

You cannot open more than 1 drawer at a time to prevent tilting risks !

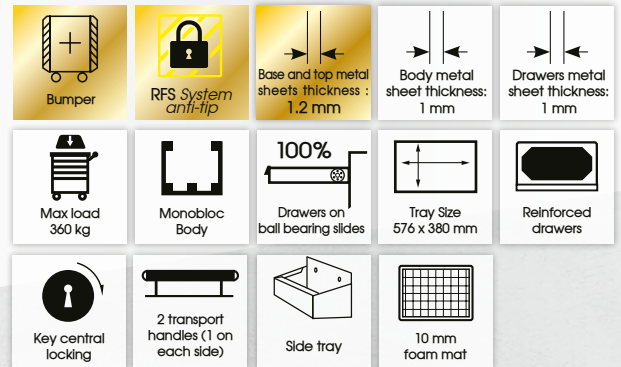

Specifications	Dimensions (mm) L x D x H		kg
	Total	820 x 475 x 775	
876348GG Total + Ø127x32 mm wheels	820 x 475 x 940		
7 drawers	576 x 380 x 75		
1 drawers	576 x 380 x 154		

SQUAD

SQUAD



**6**  
**DRAWERS**



**7**  
**DRAWERS**



**8**  
**DRAWERS**

**87SQ316BABK** £591.85 <sup>□</sup> | **87SQ317BABK** £613.21 <sup>□</sup> | **87SQ318BABK** £631.90 <sup>□</sup>

**MODEL D TOOL TROLLEY - 6 DRAWERS**

**MODEL D TOOL TROLLEY - 7 DRAWERS**

**MODEL D TOOL TROLLEY - 8 DRAWERS**

Bumper	RFS System anti-tip	Body metal sheet thickness: 1 mm	Drawers metal sheet thickness: 0.8 mm	500 kg	Key central locking
35 kg	30 kg	100% Drawers on ball bearing slides	570 x 380 mm	Reinforced drawers	

Specifications	Dimensions L x D x H (mm)		
	Total	Total + Ø127x50.8 mm wheels	
87SQ31_BABK		696x473x805	-
87SQ316BABK	3 drawers	570x380x70	65
87SQ317BABK	3 drawers	570x380x150	68
	5 drawers	570x380x70	
87SQ318BABK	2 drawers	570x380x150	71
	7 drawers	570x380x70	
	1 drawer	570x380x150	

SQUAD



**87SQ337BABK** £764.51 <sup>□</sup>

**XL MODEL D+ TOOL TROLLEY - 7 DRAWERS**

RFS System anti-tip	Bumper	Body metal sheet thickness: 1 mm	Drawers metal sheet thickness: 1 mm	700 kg	Key central locking
35 kg	30 kg	100% Drawers on ball bearing slides	850 x 380 mm	Reinforced drawers	

Specifications	Dimensions L x D x H (mm)		
	Total	Total + Ø127x50.8 mm wheels	
87SQ337BABK		981x473x805	85
	Total + Ø127x50.8 mm wheels	981x473x994	
	5 drawers	850x380x70	
	2 drawers	850x380x150	

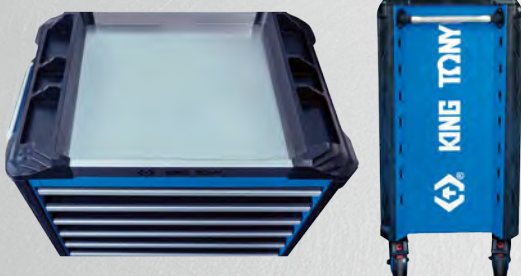

RFS - Risk-Free System : anti-tip system for optimal security.

SQUAD

# SQUAD



**87SQ327BABK**

£812.57 <sup>D</sup>

**D7X SQUAD TOOL TROLLEY - 7 DRAWERS + 1 DOOR WITH SHELF**

Bumper	RFS System anti-tip	Body metal sheet thickness: 1 mm	Drawers metal sheet thickness: 0.8 mm	700 kg	Key central locking
35 kg	30 kg	850 x 380 mm	570 x 380 mm	100% Drawers on ball bearing slides	Reinforced drawers

87SQ327BABK	Specifications	Dimensions L x D x H (mm)	85
	Total	1081x473x868	
Total + Ø127 x 50.8 mm wheels	1081x473x1043		
1 drawer	850x380x80		
4 drawers	570x380x70		
2 drawers	570x380x150		
Large compartment	295x455x635		

# SQUAD

**Superb Workbench**



**87SQ3410BABK**

£1,351.91 <sup>D</sup>

**SUPERB WORKBENCH - 10 DRAWERS - 3 CUPBOARDS**

Bumper	RFS System anti-tip	Body metal sheet thickness: 1 mm	Drawers metal sheet thickness: 0.8 mm	700 kg	Key central locking
35 kg	30 kg	25 kg	570 x 380 mm	100% Drawers on ball bearing slides	Reinforced drawers

87SQ3410BABK	Specifications	Dimensions L x D x H (mm)	160
	Total	1235x800x805	
Total + Ø127 x 50.8 mm wheels	1235x800x994		
8 drawers	570x380x70		
2 drawers	570x380x150		
Cupboard 2 doors (top)	654 x 376 x 205		
Cupboard 1 door (top)	389 x 406 x 202		
Cupboard 1 door (bottom)	791 x 523 x 329		
Vertical drawer	385 x 378		



RFS - Risk-Free System : anti-tip system for optimal security.

# SQUAD

• lockable cupboard for storing valuable tools

• Hanging accessories can be added  
• Sizes : 435 x 501 mm

• Additional storage space

• Vertical peg board drawer for hanging wrenches vertically.

• Trash bin or bottle holder can be added

• Strong worktop space

• Large metal handle

• Lockable cupboard for storing valuable tools

• 5 storage drawers

• Folding shelf can be added  
• Sizes : 426 x 499 mm

# SQUAD



**87SQ3210BANK**

£918.48<sup>D</sup>

**XL MODEL DX TOOL TROLLEY - 10 DRAWERS**

Bumper	RFS System anti-tip	Body metal sheet thickness: 1 mm	Drawers metal sheet thickness: 0.8 mm	700 kg	Key central locking
35 kg	30 kg	35 kg	100% Drawers on ball bearing slides	570 x 380 mm	Reinforced drawers



RFS - Risk-Free System : anti-tip system for optimal security.

87SQ3210BANK	Specifications		Dimensions L x D x H (mm)	
	Total	981 x 473 x 805		
Total + Ø127 x 50.8 mm wheels	981 x 473 x 994			
7 drawers	570 x 380 x 70	103		
1 drawer	570 x 380 x 150			
Large compartment	270 x 380 x 380			
Small compartment	270 x 380 x 280			

## ACCESSORIES

# SQUAD

**87SQ341A**

£20.47<sup>B</sup>

**SIDE TRAY**



Dimensions (W x H x D):  
275 x 150 x 136 mm

1.06



**87SQ342A**

£39.16<sup>B</sup>

**TRASH BIN-25 L**



Dimensions (W x H x D):  
363 x 232 x 411 mm

**87SQ351A**

£28.48<sup>B</sup>

**PAPER HOLDER**



Dimensions (W x D):  
640 x 540 mm  
For paper roll within  
280 mm wide

Only for the Serie 87SQ31\_BAK

**87SQ313A**

£40.94<sup>B</sup>

**SHELF PEGBOARD**

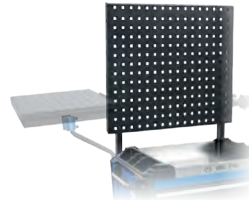

Dimensions (W x H):  
640 x 540 mm

**87SQ331A**

£103.24<sup>B</sup>

**LAPTOP HOLDER**

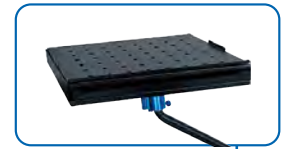

Dimensions (W x H x D):  
378 x 285 x 79 mm

**87SQ332A**

£13.35<sup>B</sup>

**PHONE HOLDER**



Dimensions (W x H):  
200 x 52 mm

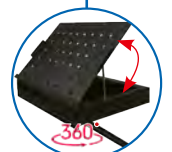

3 angles of adjustment  
are available 20°/45°/60°

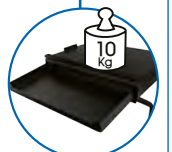

Underneath the  
rack has a drawer  
for stationary  
storage.

**87SQ323A**

£27.59<sup>B</sup>

**POWER TOOLS HOLDER**

285 x 172 x 71 mm



**87SQ311A**

£22.25<sup>B</sup>

**SIDE PEGBOARD**

325 x 683 mm

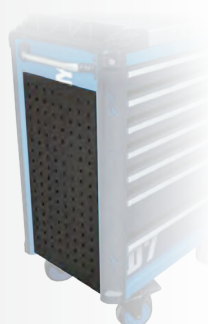

**87SQ333A**

£43.61<sup>B</sup>

**FOLDING SHELF**

398 x 280 x 179 mm



**87SQ312A**

£15.13<sup>B</sup>

**DOCUMENT HOLDER**

325 x 260 x 34 mm



**87SQ322A**

£12.46<sup>B</sup>

**BOTTLE HOLDER**

320 x 101 x 74 mm



# SQUAD



22



24

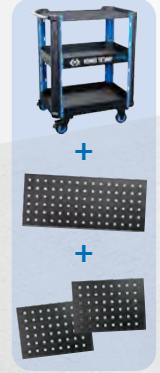

**87SQ41AB** **New** £219.83<sup>D</sup>  
**3 SHELF TOOL TROLLEY CART**

**87SQ41ABF** **New** £252.76<sup>D</sup>  
**3 SHELF TOOL TROLLEY CART WITH 3 PERFORATED PANELS**

- Optional SQUAD accessories for more functionality (87SQ323 - 87SQ333 - 87SQ341 - 87SQ342 - 87SQ351).
- Brushed steel tubular handle with a comfortable grip.
- 100 mm strengthen TPR casters for an intensive use.
- 10 mm top protection mat and 3 mm bottom shelves protection mat.



	Specifications	Dimensions L x D x H (mm)
87SQ41AB 87SQ41ABF	Total	770 x 470 x 950
	Total + Ø101.6 x 25.4 mm wheels	770 x 470 x 1050

## MAXIMIZE YOUR SPACE BY USING VERTICAL STORAGE: CHOOSE A STORAGE CHEST.



**87SQ114BABK SQUAD**

Find it in our  
**MOBILE FURNITURE RANGE**

page **82**



Integrated side handles for safe lifting and placement onto the roller cabinet



Can be paired with a sturdy and reliable SQUAD roller cabinet using 2 side handles that slot into the cabinet



**PKT87SQP2** **New** £3,114.11<sup>D</sup>

87SQ316BABK + 87SQ114BABK + 9SQL001MD + 9TA33AA



500 mm

**+** 9TA33AA

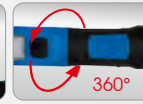
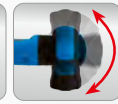

6500 K  
 10 W  
**1000 Lumen**



**+** 9SQL001MD

Find out the detailed composition of the 360 tools set available page **95**

**95**

**360 PC.**

**+**



87SQ114BABK



87SQ316BABK

1/4"

3/8"

1/2"



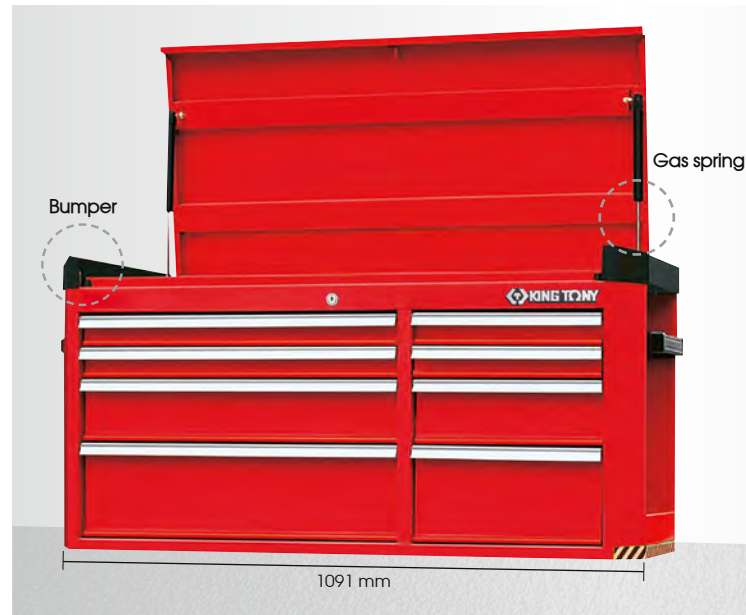



**87B5108B**

£604.31<sup>D</sup>

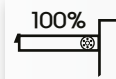
**8-DRAWER METAL TOOL CHEST WITH UPPER HOLD**

- 

100%  
Drawers on ball bearing slides
- 

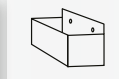
Key central locking
- 

Side tray

	Specifications	Dimensions (mm) L x D x H	
87B5108B	Total	1091 x 470 x 564	70
	1 hold	1086 x 466 x 111.5	
	2 drawers	570 x 410 x 54	
	1 drawer	570 x 410 x 112	
	1 drawer	570 x 410 x 170	
	2 drawers	313 x 410 x 54	
	1 drawer	313 x 410 x 112	
	1 drawer	313 x 410 x 170	





**87B3116B**

£1,067.11<sup>D</sup>

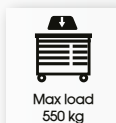
**16-DRAWER MOBILE WORKBENCH**

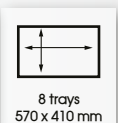
- 

Max load 550 kg
- 

8 trays 570 x 410 mm
- 

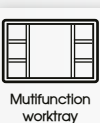
8 trays 313 x 410 mm
- 

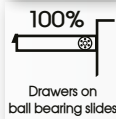
Multifunction worktray
- 

100%  
Drawers on ball bearing slides
- 

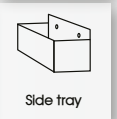
Key central locking
- 

Side tray

	Specifications	Dimensions (mm) L x D x H	
87B3116B	Total	1091 x 470 x 867	123.5
	Total + wheels	1091 x 470 x 1032	
	4 drawers	570 x 410 x 54	
	3 drawers	570 x 410 x 112	
	1 drawer	570 x 410 x 170	
	4 drawers	313 x 410 x 54	
	3 drawers	313 x 410 x 112	
	1 drawer	313 x 410 x 170	



**87B3111B**

£889.11<sup>D</sup>

**11-DRAWER MOBILE WORKBENCH**

- 

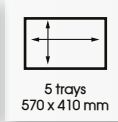
Max load 550 kg
- 

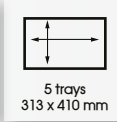
5 trays 570 x 410 mm
- 

5 trays 313 x 410 mm
- 

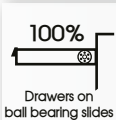
Multifunction worktray
- 

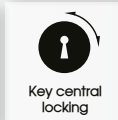
100%  
Drawers on ball bearing slides
- 

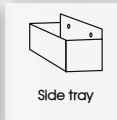
Key central locking
- 

Side tray

	Specifications	Dimensions (mm) L x D x H	
87B3111B	Total	1091 x 470 x 867	104.5
	Total + wheels	1091 x 470 x 1032	
	1 drawer	937 x 410 x 130	
	1 drawer	570 x 410 x 54	
	3 drawers	570 x 410 x 112	
	1 drawer	570 x 410 x 170	
	1 drawer	313 x 410 x 54	
	3 drawers	313 x 410 x 112	
	1 drawer	313 x 410 x 170	

87512

£1,565.51<sup>D</sup>

PRO  
series

**WORKBENCH WITH 1 ROLL DOOR CABINETS AND 3 DRAWERS**

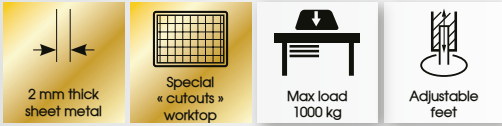

Specifications	Dimensions (mm) L x D x H	
Total	1565 x 766 x 1403	130.1
3-drawer chest	668 x 313 x 270	
2 drawers	568 x 262 x 50	
1 drawer	568 x 262 x 75	
Roll door cabinets	1565 x 203 x 603	

87502

£906.91<sup>D</sup>

**WORKBENCH WITH 1 PEGBOARD, 2 WALL CABINETS AND 3 DRAWERS**

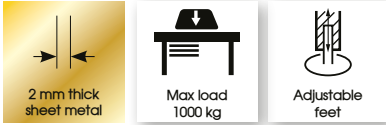

Specifications	Dimensions (mm) L x D x H	
Total	1525 x 700 x 1520	86
3-drawer chest	660 x 307 x 251	
2 drawers	569 x 275 x 50	
1 drawer	569 x 275 x 75	
Roll door cabinets	400 x 200 x 500	

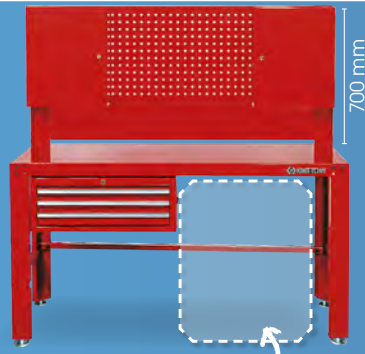

87502

STRENGTH  
series



8743 15BT

85

87502 + 8743 15BT

87502P011

£413.85<sup>D</sup>

STRENGTH  
series

**WORKBENCH**



Specifications	Dimensions (mm) L x D x H	
87502P011 Total	1525 x 700 x 800	48

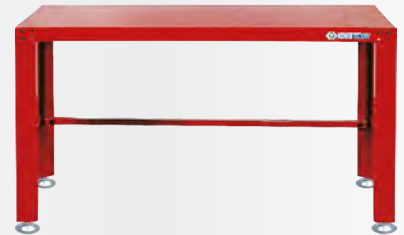

87504

£533.11<sup>D</sup>

STRENGTH  
series

**MOBILE WORKBENCH**



Specifications	Dimensions (mm) L x D x H	
87504 Total	1525 x 700 x 910	66

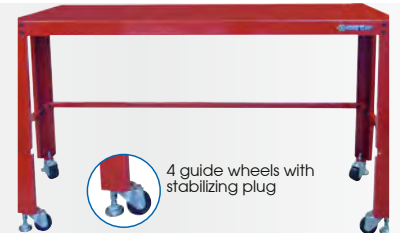

87502P91

£600.75<sup>D</sup>

STRENGTH  
series

**3 DRAWER TOOL CHEST FOR WORKBENCH**



Specifications	Dimensions (mm) L x D x H	
87502P91 Total	1525 x 700 x 800	61
3-drawer chest	660 x 307 x 251	
2 drawers	569 x 275 x 50	
1 drawer	569 x 275 x 75	



# CREATE YOUR IDEAL WORKSHOP, A WORKSHOP THAT REFLECTS WHO YOU ARE.

Available in 2 colours



DISCOVER OUR FULL RANGE OF FURNITURE ON OUR WEBSITE.

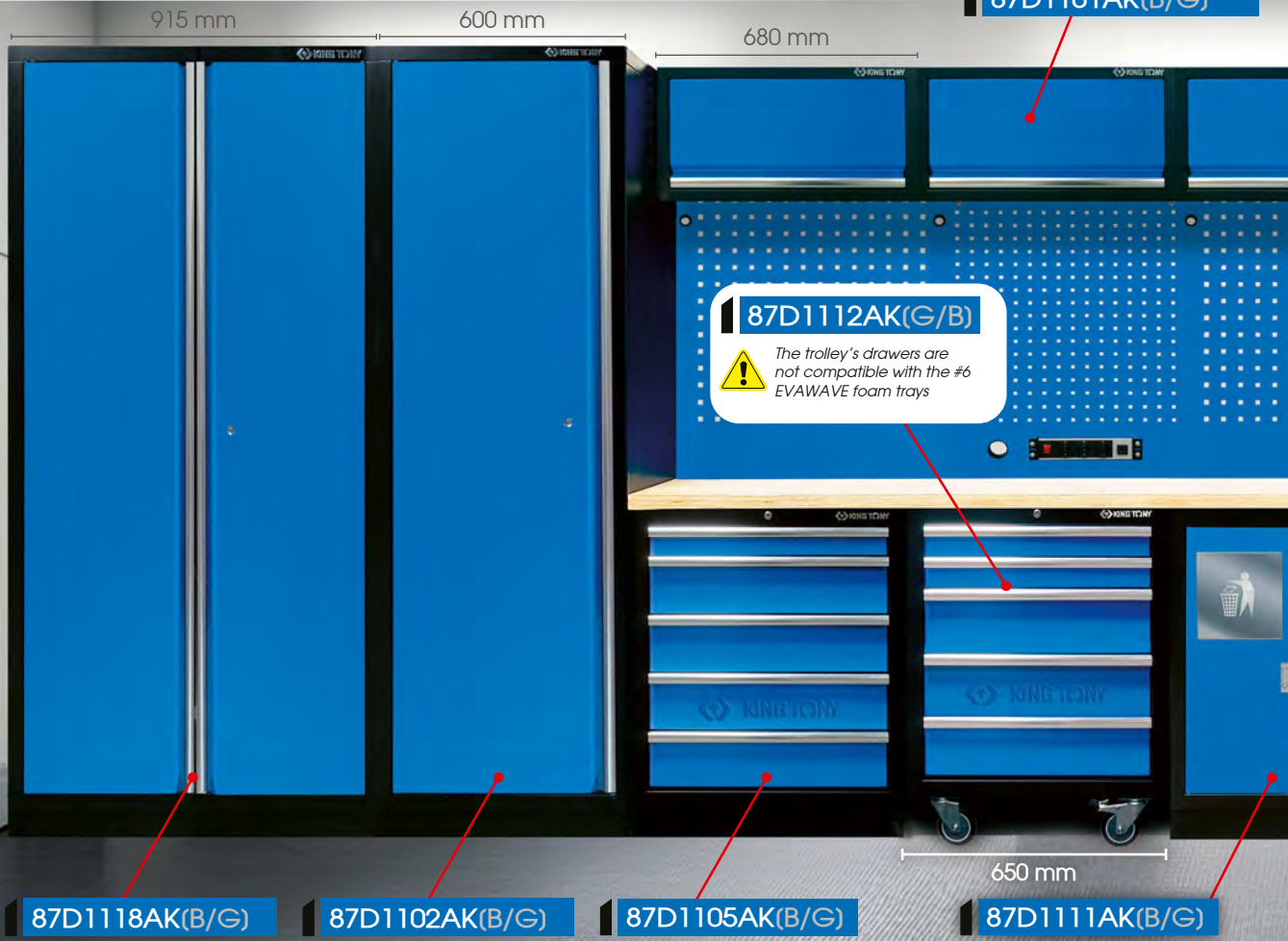

4235 mm



3930 mm



2640 mm



1965 mm

Dimensions L x D x H (mm)			
87D11AK(G/B)U		4235 x 490 x 2000	£2,988.62 <sup>D</sup>
87D11AX(G/B)U	XL	4235 x 645 x 2000	£3,015.32 <sup>D</sup>
87D11AK(G/B)US		4235 x 490 x 2000	£3,106.10 <sup>D</sup>
87D11AX(G/B)US	XL	4235 x 645 x 2000	£3,258.29 <sup>D</sup>

Dimensions L x D x H (mm)			
87D11AK(G/B)		3930 x 490 x 2000	£2,863.13 <sup>D</sup>
87D11AX(G/B)	XL	3930 x 645 x 2000	£2,928.10 <sup>D</sup>
87D11AK(G/B)S		3930 x 490 x 2000	£2,980.61 <sup>D</sup>
87D11AX(G/B)S	XL	3930 x 645 x 2000	£3,050.03 <sup>D</sup>

Dimensions L x D x H (mm)			
87D11AK(G/B)T		2640 x 490 x 2000	£1,835.18 <sup>D</sup>
87D11AX(G/B)T	XL	2640 x 645 x 2000	£1,905.49 <sup>D</sup>
87D11AK(G/B)TS		2640 x 490 x 2000	£1,881.46 <sup>D</sup>
87D11AX(G/B)TS	XL	2640 x 645 x 2000	£1,934.86 <sup>D</sup>

Dimensions L x D x H (mm)			
87D11AK(G/B)L		1965 x 490 x 2000	£1,378.61 <sup>D</sup>
87D11AX(G/B)L	XL	1965 x 645 x 2000	£1,405.31 <sup>D</sup>
87D11AK(G/B)LS		1965 x 490 x 2000	£1,439.13 <sup>D</sup>
87D11AX(G/B)LS	XL	1965 x 645 x 2000	£1,517.45 <sup>D</sup>

**New**

Thickness 35 mm

87D11061AK(G/B) £95.23<sup>D</sup>

**PERFORATED PANEL WITH INTEGRATED POWER STRIP**

**New**

**MORE SPACE, MORE EFFICIENCY:  
UPGRADE TO THE XL WORKTOP.**

Starting from your classic furniture, add our new worktop with its kit to transform your setup into extra large.

FROM **490 mm** TO **645 mm**

**XL**



87D1117AKG

87D1116AK(G/B) £64.97<sup>D</sup>

87D1115AK(G/B) £219.83<sup>D</sup>

87D1106AK(B/G)

87D11061AK(B/G)

New

87E02051A

x10

87E02053A

x10

87E02061A

x10

87E02063A

x10

87D1119AK(B/G) £636.35<sup>D</sup>

87D1104AK(B/G)

87D1103AK(B/G)

87D1113AK(G/B) £371.13<sup>D</sup>

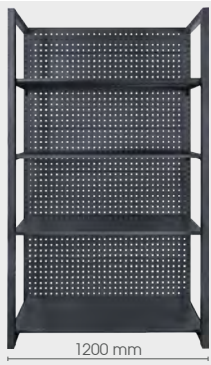

**STORAGE SHELVES**

Compatible with 87D11 workshop furniture range.



Dimensions L x D x H (mm)



87D1120LAK	1200 x 458 x 2000	55
87D1120AK	680 x 458 x 2000	41

1200 mm

680 mm

87D1120LAK

£298.15<sup>D</sup>

87D1120AK

£226.95<sup>D</sup>



**FULL WORKSHOP STORAGE SOLUTION**

87D11AK(G/B)V £1,223.75<sup>D</sup>



Specifications

Dimensions L x D x H (mm)



	Total	1360 x 490 x 2000	
87D11AK_V	1 drawer	1272 x 403 x 84	112
	5 drawers	783 x 403 x 58	
	1 drawer	783 x 403 x 137	
	2 doors	284 x 371 x 531	

1360 mm



• Storage box

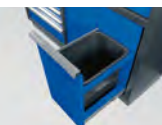

• Garage bin



• Safety mechanism



• Drawers on ball bearing slides

New

87D11AK(G/B)CO

**COMPLETE CORNER UNIT**

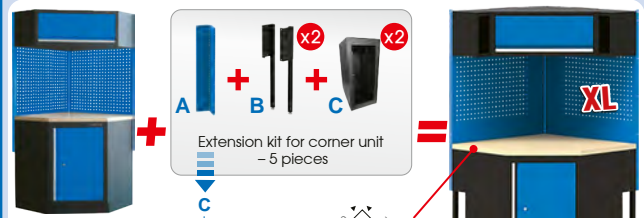
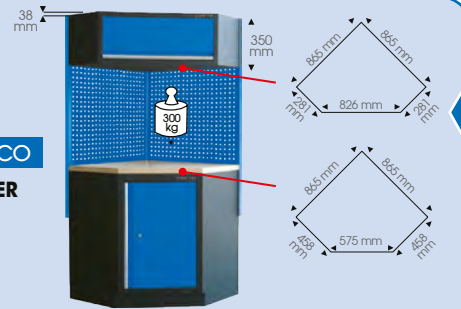

87D11AKBCO

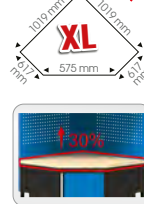
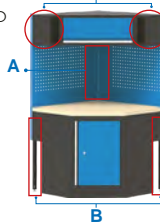

87D11AX(G/B)CO

**COMPLETE CORNER UNIT XL VERSION**

87D11AK(G/B)CO 2640 x 490 x 2000 £839.27<sup>D</sup>

87D11AX(G/B)CO XL 2640 x 645 x 2000 £949.63<sup>D</sup>

87D11AK(G/B)COS 2640 x 490 x 2000 £898.01<sup>D</sup>

87D11AX(G/B)COS XL 2640 x 645 x 2000 £1,003.92<sup>D</sup>



9G33001MD1

1/4" 3/8" 1/2"

£2,028.31<sup>D</sup>

LIFETIME GUARANTEE\*

Contents

2335M	5.5, 6, 7, 8, 9, 10, 11, 12, 13, 14
4335M	10, 11, 12, 13, 14, 15, 16, 17, 18, 19, 21, 22, 23, 24, 27, 30, 32
4235M	8, 9, 10, 11, 12, 13, 14, 15, 16, 17, 18, 19
3375M	E8
4375M	E10, E12, E14, E16, E18, E20, E22, E24
4033	T55, T70
4049	M7, M8, M9, M10, M12, M13, M14, M16
4036	M6, M8, M10, M12
4035	H6, H8, H10, H12
4026	M14, M16, M18
1025H	H3, H4, H5, H6
1025U	T10H, T15H, T20H, T25H, T27H, T30H, T40H
1025Z	PZ1, PZ2
275955G	475910G
257145	2178DF
2142	222102, 222104
425105, 425110	2792
4791	2813, 4813
3335M	6, 7, 8, 9, 10, 11, 12, 13, 14, 15, 16, 17, 18, 19, 21, 22, 24
377108G	345308F
329303, 329306	357108, 3792
4435M	10, 11, 12, 13, 14, 15, 16, 17, 18, 19, 21, 22, 24, 27, 30, 32, 33, 34, 36
4945MX	17, 19, 21
7713308	6AB3175
9AE32110 (Ø65-120)	
9AE43	34440A, 159609
344231A (42-100 Nm)	158609

1062	6, 8, 10, 11, 13, 14, 16, 17, 18, 19, 21, 22, 24, 27, 30, 32
373AM	8, 9, 10, 11, 12, 13, 14, 15, 16, 17, 18, 19, 22, 24
1025S	3.0, 4.0, 5.0, 6.0
1025P	PH1, PH2 x 2, PH3
1025Z	PZ1, PZ2 x 2, PZ3
1025T	T10, T15, T20, T25, T27, T30, T40
1025H	H3, H4, H5, H6
1025U	T10H, T15H, T20H, T25H, T27H, T30H, T40H
1025R	
1636H	H5, H6, H7, H8, H10, H12
1636M	M6, M8, M10, M12
1636T	T30, T40, T45, T50, T55, T60
1832H	H3, H4, H5, H6, H7, H8, H10, H12
1832T	T15, T20, T25, T27, T30, T40, T45, T50
1836P	PH2, PH3
1836S	9 x 1.6, 11 x 2
1880P	PH2, PH3
1880S	8 x 1.2, 10 x 1.6
414810M, 414810S	4112
75363	770225, 7732826
276A04G	361106R, 361108R
10D0	10, 12, 13, 14, 17, 18, 19
1130MR	H2.5, H3, H4, H5, H6, H8, H10
1130SR	3/32", 1/8", 5/32", 3/16", 1/4", 5/16", 3/8"
1147R	T10H, T15H, T20H, T25H, T27H, T30H, T40H
1120MR	H1.5, H2, H2.5, H3, H4, H5, H6, H7, H8
1143R	T10, T15, T20, T25, T27, T30, T40, T45, T50

1970	6x7, 8x9, 10x11, 12x13, 14x15, 16x17, 18x19, 20x22, 24x27, 30x32
1930	8x10, 10x12, 11x13, 12x14, 17x19, 19x22
1421	PH0 x 60, PH2 x 38
1422	3 x 75, 6.5 x 38
1461	PH2 x 100, PH3 x 150
1462	6.5 x 100, 8 x 150
1427	T8Hx75, T10Hx75, T15Hx75, T20Hx100, T25Hx100, T27Hx100, T30Hx125
1421 extra long	PH2 x 300
1422 extra long	6.5 x 300
43280212	212118
7713106	7734020
7909405M	9DC23
793204	797107
74408	
66HS07	66HB07
66SS07	66SB07
611107	631106
621106	651710C
785116	784310
786238	782027
764G	Ø 2, Ø 3, Ø 4, Ø 5, Ø 6, Ø 8, Ø 10, Ø 12, Ø 14
762G	18, 22, 9TK108, 9TK112

\*The guarantee is unlimited in time, excludes impact tools cutting tools and 1/4" screw bits.

recommended with **SQUAD** (87SQ337BABK)





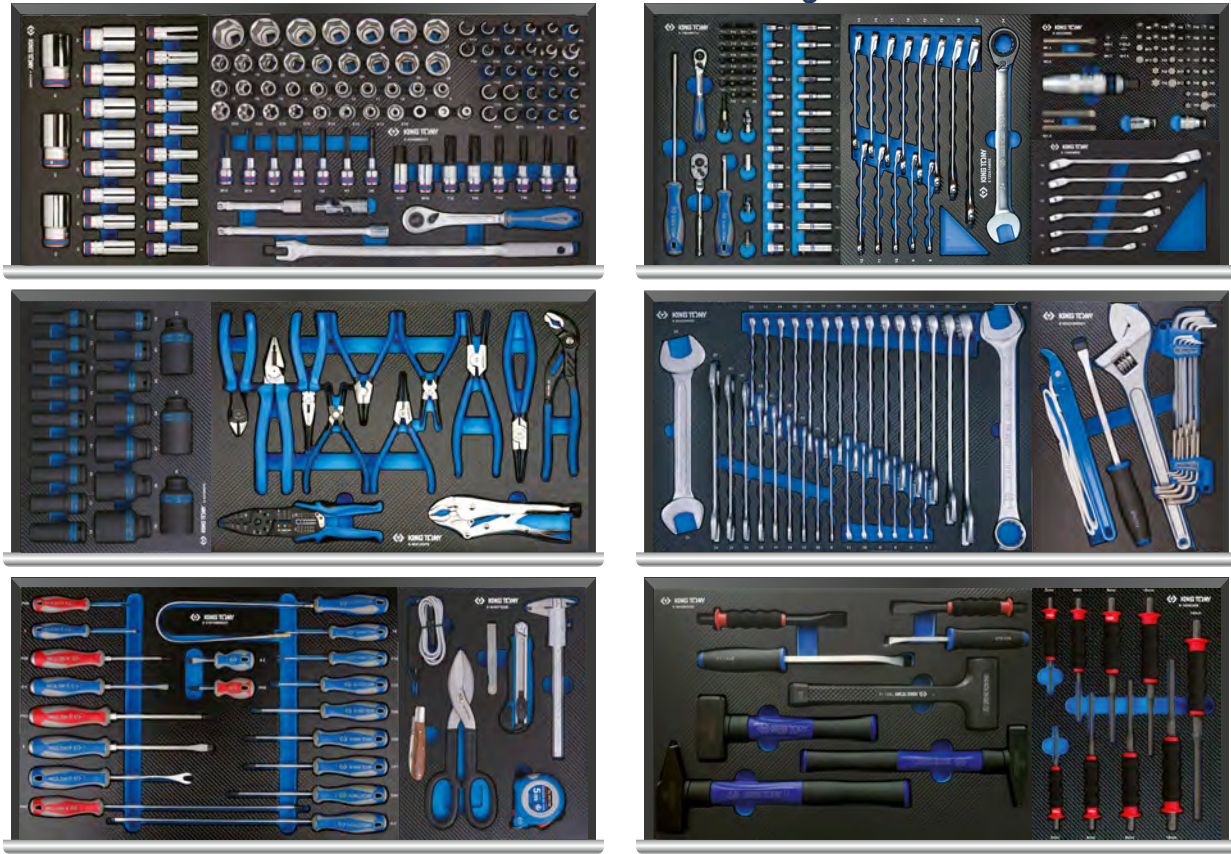









































































86



**9SQL001MD** 1/4" 3/8" 1/2" **£2,255.26<sup>D</sup>** **LIFETIME GUARANTEE\***

Contents

43.29

 4230M	8, 9, 10, 11, 12, 13, 14, 15, 16, 17, 18, 19, 21, 22, 24, 27, 30, 32, 33, 34, 36	 1421	PH0 x 60, PH2 x 38	 75260	 770225
 4335M	8, 9, 10, 11, 12, 13, 14, 15, 16, 17, 18, 19, 20, 21, 22, 23, 24, 25, 26, 27, 28, 29, 30, 32, 33, 36	 1422	3 x 75, 6.5 x 38	 2792	 2142
 4375M	E10, E12, E14, E16, E18, E20, E22, E24	 1461	PH2 x 100, PH3 x 150	 2813	
 4025	H6, H7, H8, H10, H12, H14, H17	 1462	6.5 x 100, 8 x 150	 373A	8, 9, 10, 11, 12, 13, 14, 15, 16, 17, 18, 19, 22, 24
 4023	T20, T25, T27, T30, T40, T45, T50, T55, T60, T70	 1427	T8H x 75, T10H x 75, T15H x 75, T20H x 100, T25H x 100, T27H x 100, T30H x 125	 1836S	9 x 1.6, 11 x 2
 4026	M5, M8, M10, M12, M14	 1421 extra long	PH2 x 300	 1880S	8 x 1.2, 10 x 1.6
 4027	T30, T40, T45, T50, T55, T60	 1422 extra long	6.5 x 300	 1836P	PH2, PH3
 4035	H6, H7, H8, H10	 43280212		 1880P	PH2, PH3
 4033	T40, T45, T50, T55, T60, T70	 212118		 1832H	H3, H4, H5, H6, H7, H8, H10, H12
 4036	M8, M10, M12	 7713106		 1832T	T15, T20, T25, T27, T30, T40, T45, T50
 402B	M16	 7909405M		 1636H	H5, H6, H7, H8, H10, H12
 477310GS	445318F	 7734020		 1636T	T30, T40, T45, T50, T55, T60
 414808S, 414810S, 414810M	4791	 793204		 1636M	M6, M8, M10, M12
 429305, 429310		 74408		 414810M	4112
 4435M	10, 11, 12, 13, 14, 15, 16, 17, 18, 19, 21, 22, 24, 27, 30, 32, 33, 34, 36	 797107		 414810S	4112
 651710C	 623107	 2335M	3, 2, 4, 5, 5.5, 6, 7, 8, 9, 10, 11, 12, 13, 14	 1900	8x9, 10x11, 12x13, 14x15, 16x17, 18x19, 20x22, 21x23, 24x27, 30x32
 631108	 611209	 2235M	4, 4.5, 5, 5.5, 6, 7, 8, 9, 10, 11, 12, 13, 14	 1062	6, 7, 8, 9, 10, 11, 12, 13, 14, 15, 16, 17, 18, 19, 20, 21, 22, 23, 24, 27, 30, 32
 68HB07	 68HS07	 1025P	PH1, PH2, PH3	 1930	8x10, 10x12, 11x13, 12x14, 17x19, 19x22
 68SB07	 68SS07	 1025S	3, 4, 5, 6	 762G	18, 22
 68HS10	 68SS10	 1025H	H3, H4, H5, H6	 9TK108, 9TK112	785116
 672010	 601110	 1025Z	P21, P22, P23	 784310	782027
		 1025T	T10, T15, T20, T25, T27, T30, T40	 786238	
		 1025U	T10H, T15H, T20H, T25H, T27H, T30H, T40H	 1147R	T10H, T15H, T20H, T25H, T27H, T30H, T40H, T45H, T50H
		 277355GS	278106P	 1120MR	1.5, 2, 2.5, 3, 4, 5, 6, 8, 10
		213312DF	2178DF	361115R	
				32067A	9TK112
				764G	Ø 2, Ø 3, Ø 4, Ø 5, Ø 6, Ø 8, Ø 10, Ø 12, Ø 14

\*The guarantee is unlimited in time, excludes impact tools cutting tools and 1/4" screw bits.

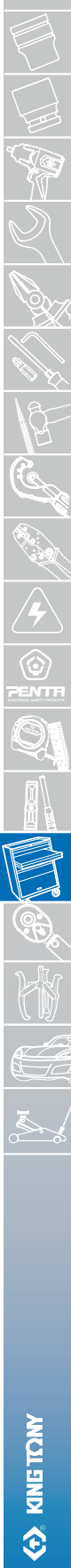

# 325 TOOLS SET

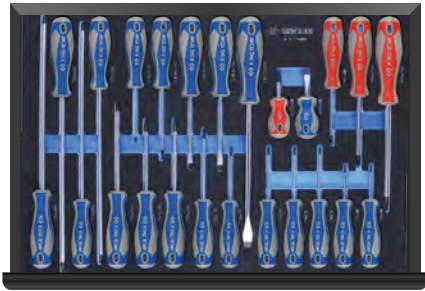

**934A 11MVD2** 1/4" 3/8" 1/2" **1/4" + 3/8" + 1/2"** **£1,263.80<sup>D</sup>** **LIFETIME GUARANTEE\***

**Contents**

2335M	4, 4.5, 5, 5.5, 6, 7, 8, 9, 10, 11, 12, 13, 14
2235M	4, 4.5, 5, 5.5, 6, 7, 8, 9, 10, 11, 12, 13, 14
2375M	E4, E5, E6, E7, E8
2013X	T8, T9, T10, T15, T20, T25, T27, T30, T40
2015MX	H3, H4, H5, H6, H8
2018X	P21, P22
2011X	PH1, PH2
2012X	3.5, 5.5, 8
1025T	T6, T7
1025M	M4, M5, M6, M8, M10
2792	2813
276A04G	
222102, 222104, 222106	
3335M	10, 11, 12, 13, 14, 15, 16, 17, 18, 19, 20, 21, 22
3375M	E7, E8, E10, E11, E12
3230M	8, 10, 11, 12, 13, 14, 16, 17, 19
3750M	10, 11, 12, 13, 14, 15, 16, 17, 18, 19
3812, 3814	377908G
322314	
322103, 322106, 322110	
4335M	8, 10, 11, 12, 13, 14, 15, 16, 17, 18, 19, 20, 21, 22, 23, 24, 26, 27, 28, 30, 32
4375M	E10, E12, E14, E16, E18, E20, E22, E24
463516R, 463521R	
463014RC	
4791	477910G
429302	425105, 425110

1636H	H5, H6, H7, H8, H10, H12
1636M	M6, M8, M10, M12
1636T	T30, T40, T45, T50, T55, T60
1832H	H3, H4, H5, H6, H7, H8, H10, H12
1832T	T15, T20, T25, T27, T30, T40, T45, T50
1836P	PH2, PH3
1836S	9 x 1.6, 11 x 2
1880P	PH2, PH3
1880S	8 x 1.2, 10 x 1.6
414810M, 414810S	4112
1062	6, 7, 8, 9, 10, 11, 12, 13, 14, 15, 16, 17, 18, 19, 21, 22, 24, 27, 30, 32
1900	6x7, 8x9, 10x11, 12x13, 14x15, 16x17, 18x19, 20x22, 21x23, 24x27, 25x28, 30x32
1970	6x7, 8x9, 10x11, 12x13, 14x15, 16x17, 18x19, 20x22, 24x27, 30x32
1143	T10, T15, T20, T25, T27, T30, T40, T45, T50
1930	8x10, 10x12, 11x13, 12x14, 17x19, 19x22
1120MR	H1.5, H2, H2.5, H3, H4, H5, H6, H8, H10
1421	PH2x38, PH1x80, PH2x100, PH3x150
1422	3x75, 4x100, 5.5x100, 6.5x100, 10x200, 6.5x38
1423	T6x48, T7x48, T8x75, T9x75, T10x75, T15x75, T15x250, T20x100, T20x250, T25x100, T25x250, T27x100, T30x125, T30x250

PH2x300	
6.5x300	
1160MR	H2, H2.5, H3, H4, H5, H6, H8, H10
115HM	8, 10, 13
115345R	9C2101
48280180	43280212
43240115V	7540208G
7510208G	7550208G
7520208G	7530208G
611106	623107
631108	631911C
601110	631405
651610C	
66HS07	66SB07
66HB07	66SS07
7610405	
7621706, 7622007	
7640305, 7640406, 7640565, 7640607	
782130	
9DC23	212118
796204	796304

\* The guarantee is unlimited in time, excludes impact tools, measuring tools, power tools, pullers, wire brush, file and 1/4" screw bits.

# 281 TOOLS SET

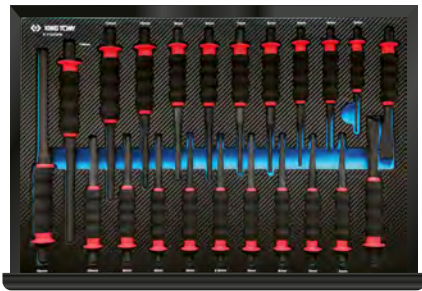
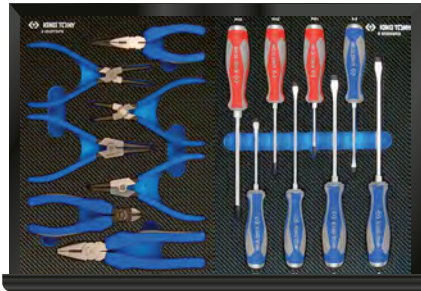
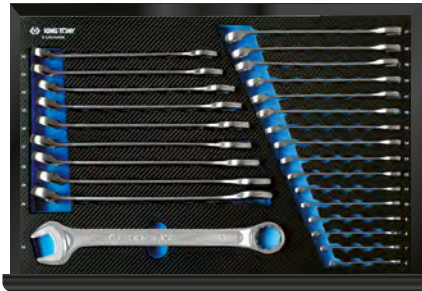

93228 1MRED 1/4" 1/2" 3/4" 1/4" + 1/2" + 3/4" £1,650.95<sup>D</sup> LIFETIME GUARANTEE\*

Contents

46.06

	2335M	4, 4.5, 5, 5.5, 6, 7, 8, 9, 10, 11, 12, 13
	2375M	E4, E5, E6, E7, E8
	4375M	E10, E12, E14, E16, E18, E20
	4435M	10, 11, 12, 13, 14, 17, 19, 21, 22, 24
	4335M	8, 9, 10, 11, 12, 13, 14, 15, 16, 17, 18, 19, 20, 21, 22, 23, 24, 25, 26, 27, 28, 29, 30, 32, 33, 36
	6335M	33, 34, 35, 36, 38, 41, 46, 50
	4375M	E10, E12, E14, E16, E18, E20, E22, E24
	1062	6, 7, 8, 9, 10, 11, 12, 13, 14, 15, 16, 17, 18, 19, 20, 21, 22, 23, 24, 25, 26, 27, 28, 29, 30, 32
	4025	H6, H7, H8, H10, H12, H14, H17
	4023	T20, T25, T27, T30, T40, T45, T50, T55, T60, T70
	4026	M5, M8, M10, M12, M14
	4027	T30H, T40H, T45H, T50H, T55H, T60H
	4035	H6, H7, H8, H10
	4033	T40, T45, T50, T55, T60, T70
	4036	M8, M10, M12
	402B	M16

	1636H	H5, H6, H7, H8, H10, H12
	1636M	M6, M8, M10, M12
	1636T	T30, T40, T45, T50, T55, T60
	1832H	H3, H4, H5, H6, H7, H8, H10, H12
	1832T	T15, T20, T25, T27, T30, T40, T45, T50
	1836P	PH2, PH3
	1836S	9 x 1.6, 11 x 2
	1880P	PH2, PH3
	1880S	8 x 1.2, 10 x 1.6
	1120MR	H1.5, H2, H2.5, H3, H4, H5, H6, H8, H10
	1147R	T10H, T15H, T20H, T25H, T27H, T30H, T40H, T45H, T50H
	275555G	2792
	2177NU	257145
	245205F	222102, 222104
	475510G	445218F
	429305, 429310	4791
	414808S, 414810S, 414810M	
	677820FS	
	625104, 625108, 625116	6814
	657220	

	414810M, 414810S	4112
	1461	PH1 x 75, PH2 x 100, PH3 x 150
	1462	5.5 x 100, 6.5 x 100, 6.5 x 150, 8 x 150, 8 x 175
	611108	621106
	631106	
	68HS07	68HB07
	68SS07	68SB07
	361112P	651110
	764G	ø3, ø4, ø5, ø6, ø7, ø8, ø9, ø10, ø12, ø14, ø16
	762G	18, 22 (x2)
	761G	ø2.5, ø4, ø6, ø8, ø10
	763G	ø2, ø3, ø4, ø5
	9TK108, 9TK112	785116
	784310	782027
	786238	782130OS
	7713106	7734020
	7909405M	9DC23
	797107	74408
	3204	793204

\* The guarantee is unlimited in time, excludes impact tools, measuring tools, power tools and cutting tools.

# 263 TOOLS SET

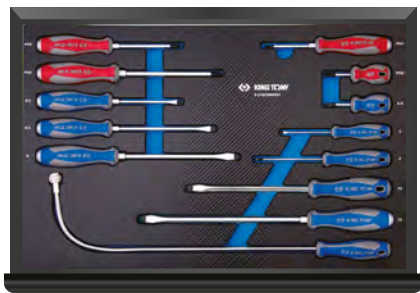

934263MRED

1/4"

1/2"

1/4" + 1/2"

£1,529.91<sup>D</sup>

LIFETIME GUARANTEE\*

## Contents

	2335M	4, 4.5, 5, 5.5, 6, 7, 8, 9, 10, 11, 12, 13
	2375M	4, 5, 6, 7, 8
	275955G	257 145
	245205F	
	222102, 222104	2792
	2177DF	
	2142	4112
	1025P	PH1, PH2, PH3
	1025Z	PZ1, PZ2, PZ3
	1025H	3, 4, 5, 6
	1025U	T7H, T8H, T9H, T10H, T15H, T20H, T25H, T27H, T30H, T40H
	1832H	H3, H4, H5, H6, H7, H8, H10, H12
	1832T	T15, T20, T25, T27, T30, T40, T45, T50
	1636H	H5, H6, H7, H8, H10, H12
	1636T	T30, T40, T45, T50, T55, T60
	1636M	M6, M8, M10, M12
	1836S	11 x 2.0, 9 x 1.6
	1836P	PH2, PH3
	1061	6, 7, 8, 9, 10, 11, 12, 13, 14, 15, 16, 17, 18, 19, 20, 21, 22, 23, 24, 25, 26, 27, 28, 29, 30, 32
	1147R	T10, T15, T20, T25, T27, T30, T40, T45, T50
	1120MR	H1.5, H2, H2.5, H3, H4, H5, H6, H8, H10

	4335M	8, 9, 10, 11, 12, 13, 14, 15, 16, 17, 18, 19, 20, 21, 22, 23, 24, 25, 26, 27, 28, 29, 30, 32, 33, 36
	4375M	E10, E12, E14, E16, E18, E20, E22, E24
	402B	M16
	4025	H6, H7, H8, H10, H12, H14 H17
	4023	T20, T25, T27, T30, T40, T45, T50, T55, T60, T70
	4026	M14, M12, M10, M8, M5
	4027	T30, T40, T45, T50, T55, T60
	4035	H6, H7, H8, H10
	4036	M8, M10, M12
	4033	T40, T45, T50, T55, T60, T70
	4148	414810M (10 mm), 414810S (5/16"), 414808S (1/4")
	477310GS	
	445318F	
	429305, 429310	4791
	1461	PH2 x 75, PH2 x 100, PH3 x 150
	1421	PH2 x 38
	1462	5.5 x 100, 6.5 x 150, 8.0 x 175, 12 x 250
	1422	6.5 x 38, 3 x 75, 4x 100, 10.0 x 200
	2121A18	

	361115	32067A
	9TK112	
	6CB21	672110
	9DC22	7951212
	7713106	7734020
	7906320	7909405M
	792112	797107
	651710C	6AB3175
	761G	Ø 2.5, Ø 4, Ø 6, Ø 7, Ø 8
	762G	Ø 22
	764G	Ø 3, Ø 4, Ø 5, Ø 6, Ø 8, Ø 10, Ø 12, Ø 14
	7622610GR	7821800S
	786238	784315
	66HS07	66SB07
	66HB07	66SS07
	611107	621106
	631106	

39.85

\* The guarantee is unlimited in time, excludes impact tools, measuring tools, power tools, cutting tools and 1/4" screw bits.

New

Available in March



9A005CRV

1/4"

1/2"

1/4" + 1/2"

£1,601.11<sup>D</sup>

LIFETIME GUARANTEE\*

Contents

27.27

	2335S	5/32", 3/16", 7/32", 1/4", 9/32", 5/16", 11/32", 3/8", 7/16", 15/32", 1/2"		344621DG	40-200 Nm		651708C, 651710C, 651712C
	2235S	5/32", 3/16", 7/32", 1/4", 9/32", 5/16", 11/32", 3/8", 7/16", 1/2"		344623DG	20-100 Nm		621106
	3330S	3/8", 7/16", 15/32", 1/2", 9/16", 19/32", 5/8", 11/16", 3/4"		9BK11			623208
	4230S	7/16", 1/2", 11/16", 3/4", 13/16", 7/8", 15/16"		1025S	3.0, 4.0, 5.0, 6.0		611405
	4330S	13/32", 7/16", 15/32", 1/2", 9/16", 19/32", 5/8", 11/16", 3/4", 25/32", 13/16", 1-1/16", 7/8", 15/16", 1", 1-3/16"		1025P	PH1, PH2 x 2, PH3		66HB07
	3635	16, 21		1025Z	PZ1, PZ2 x 2, PZ3		66SS07
	36A0	14		1025T	T10, T15, T20, T25, T27, T30, T40		66HS07
	5060	1/4", 5/16", 3/8", 7/16", 1/2", 9/16", 5/8", 11/16", 3/4", 13/16", 7/8", 15/16", 1", 1-1/16", 1-1/8", 1-3/16", 1-1/4"		1025H	H3, H4, H5, H6		66SB07
	4025S	3/16", 7/32", 1/4", 9/32", 1/2", 5/16", 3/8", 7/16", 9/16", 5/8", 3/4"		1025U	T10H, T15H, T20H, T25H, T27H, T30H, T40H		7906306
	4025	H3, H4, H5, H6, H7, H8, H9, H10, H11, H12, H14, H17, H19		1130MR	H2.5, H3, H4, H5, H6, H8, H10		75RF09M
	3023	T10, T15, T20, T25, T27, T30, T40, T45, T50		1130SR	3/32", 1/8", 5/32", 3/16", 1/4", 5/16", 3/8"		7734020
	3025	H3, H4, H5, H6, H8, H10, H12		1147R	T10H, T15H, T20H, T25H, T27H, T30H, T40H		7909505M
	4945M	15, 17, 19, 21, 22		1025R	RB2		7713308
	9BW4501	17		770225			792112
	9BW4502	21		75363			7510210G
	322103, 322110	3812		361106R, 361108R	7732826		7520210G
	425105, 425110	2792		361106G, 361108G	276A04G		7540210G
	446218F	3792		9DM1361	9DN12		7550210G
	476210P	4791R		9DC242	620705		7530210G
	376108P	276955P		797707	6AB1255		
	222102, 222104	2813					

\* The guarantee is unlimited in time, excludes impact tools, measuring tools, power tools, cutting tools and 1/4" screw bits.

# 187 TOOLS SET

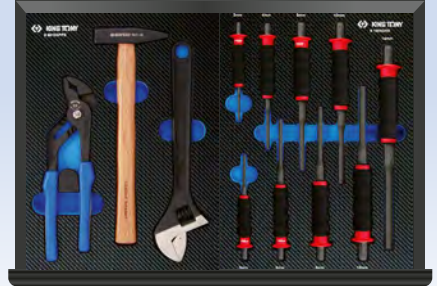
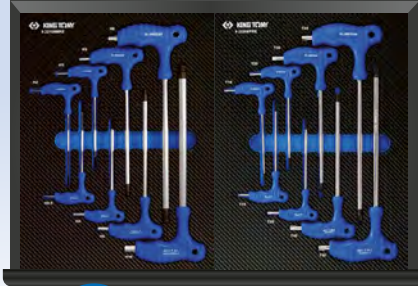
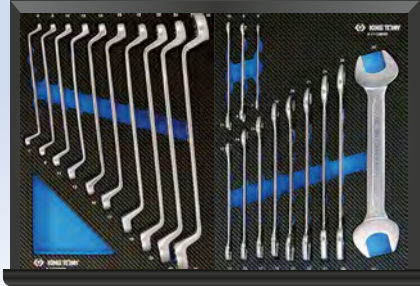
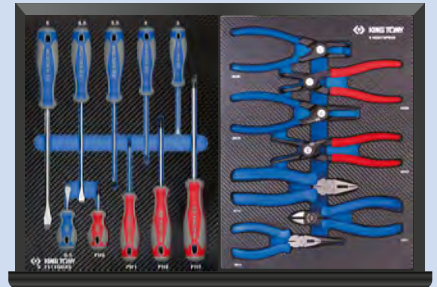
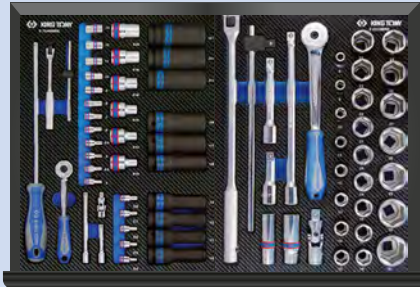

## 932187MED2 **New**

1/4" 1/2"

1/4" + 1/2"

£1,067.11 D

28.84

Contents

2335M	4, 4.5, 5, 5.5, 6, 7, 8, 9, 10, 11, 12, 13
2375M	E4, E5, E6, E7, E8
4375M	E10, E12, E14, E16, E18, E20
4435M	10, 11, 12, 13, 14, 17, 19, 21, 22, 24
275955G	2792
21777NU	257145
245205F	222102, 222104
4335M	8, 9, 10, 11, 12, 13, 14, 15, 16, 17, 18, 19, 20, 21, 22, 23, 24, 25, 26, 27, 28, 29, 30, 32
4635	16, 20, 28
475910G	457212
445215F	4791
425103, 425105, 425110	

4033	T20, T25, T27, T30, T40, T45, T50, T55, T60
4035	H4, H5, H6, H7, H8, H10, H12, H14, H17
1120MR	H1.5, H2, H2.5, H3, H4, H5, H6, H8, H10
1930	10x11, 12x14, 14x17
3204	621106
611107	631106
66HS07	66SB07
66HB07	66SS07
1163TR	T10H, T15H, T20H, T25H, T30H, T40H, T45H, T50H
1160MR	H2, H2.5, H3, H4, H5, H6, H8, H10

1062	6, 8, 10, 11, 13, 14, 16, 17, 18, 19, 21, 22, 24, 27, 30, 32
1900	6x7, 8x9, 10x11, 12x13, 14x15, 16x17, 18x19, 20x22, 21x23, 24x27, 25x28, 30x32
1970	6x7, 8x9, 10x11, 12x13, 14x15, 16x17, 18x19, 20x22, 24x27, 30x32
75°	
1421	PH1 x 80, PH2 x 38, PH2 x 100, PH3 x 150
1422	3 x 75, 4 x 100, 5.5 x 125, 6.5 x 38, 6.5 x 150, 8 x 175
361112P	651110
782130OS	
764G	Ø 2, Ø 3, Ø 4, Ø 5, Ø 6, Ø 8, Ø 10, Ø 12, Ø 14

# 155 TOOLS SET

1/4" 1/2"

LIFETIME GUARANTEE\*



## 934008MED7 1/4" + 1/2"

£622.11 D

## 934008MED8 1/4" + 1/2"

£622.11 D

17.69

Contents

2335M	5.5, 6, 7, 8, 9, 10, 11, 12, 13, 14
4335M	10, 11, 12, 13, 14, 15, 16, 17, 18, 19, 21, 22, 24, 27, 30, 32
4235M	8, 9, 10, 12, 13, 14, 15, 16, 17, 18, 19
4375M	E10, E12, E14, E16, E18
4033	T30, T40, T50, T55
4049	M8, M9, M10, M12
4036	M8, M10, M12
4035	H6, H8, H10
4026	M14
402B	M16, M18
1025H	H3, H4, H5, H6
1025U	T7H, T8H, T9H, T10H, T15H, T20H, T25H, T27H, T30H, T40H
1025Z	P21, P22, P23
1025P	PH1, PH2, PH3

934008MED7 →	275955G	475910G
934008MED8 →	277155G	477110G
257145	2178DF	
213312DF	2142	2745
222102, 222104	2792	
425105R, 425110R	4791R	
1062	6, 7, 8, 9, 10, 11, 12, 13, 14, 15, 16, 17, 18, 19, 20, 21, 22, 23, 24	
1421	PH1 x 80, PH2 x 38, PH2 x 100, PH3 x 150	
1422	3 x 75, 4 x 100, 5.5 x 125, 6.5 x 38, 6.5 x 150, 8 x 175	

1120MR	H1.5, H2, H2.5, H3, H4, H5, H6, H7, H8
1147R	T10, T15, T20, T25, T27, T30, T40, T45, T50
651710C	631106
611107	621106
67HS07	67SB07
67HB07	67SS07
7610405	782130
7621706, 7622007	
7640305, 7640406, 7640565, 7640607	

\*The guarantee is unlimited in time, excludes impact tools and 1/4" screw bits.



# BASE WITH 108 TOOLS

LIFETIME GUARANTEE\*

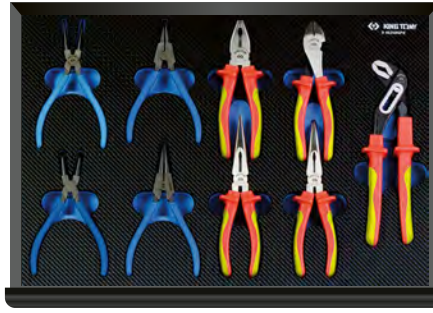

Contents

22.9

2335M	4, 4.5, 5, 5.5, 6, 7, 8, 9, 10, 11, 13, 14
2235M	4, 5, 5.5, 6, 7, 8, 9, 10, 11, 13, 14
275955G	222102, 222104
2142	2813
2792	
4335M	8, 9, 10, 11, 12, 13, 14, 15, 16, 17, 18, 19, 20, 21, 22, 23, 24, 25, 26, 27, 28, 29, 30, 32
4635	16, 20, 8
475910G	457212
445215F	4791
425103, 425105, 425110	

4033	T20, T25, T27, T30, T40, T45, T50, T55, T60
4035	H4, H5, H6, H7, H8, H10, H12, H14, H17
68HB07	68HS07
68SS07	68SB07
633608A	631808A
651610A	611607A
623607A	

1421	PH0 x 60
1422	3x75, 4x100, 5.5 x 150, 6.5x150, 8x175
1427	T10H x 75, T15H x 75, T20H x 100, T25H x 100, T27H x 100, T30H x 125, T40H x 150
1428	PZ1x100, PZ3x150
762G	22
764G	ø4, ø5, ø6

3 trays (+) 2 of your choice

+ 58 TOOLS = 166 TOOLS SET

+ 49 TOOLS = 157 TOOLS SET



934016MED4

£817.91<sup>D</sup>

Contents

1062	6, 7, 8, 9, 10, 11, 12, 13, 14, 15, 16, 17, 18, 19, 20, 21, 22, 23, 24, 25, 26, 27, 28, 29, 30, 32
1900	6x7, 8x9, 10x11, 12x13, 14x15, 16x17, 18x19, 20x22, 21x23, 24x27, 25x28, 30x32
1120MR	H1.5, H2, H2.5, H3, H4, H5, H6, H8, H10
1147R	T10H, T15H, T20H, T25H, T27H, T30H, T40H, T45H, T50H
3204	781140OS



934016MED5

£809.01<sup>D</sup>

Contents

1062	8, 9, 10, 11, 12, 13, 14, 15, 16, 17, 18, 19, 22, 24, 27, 29, 30, 32
1080	8, 9, 10, 11, 12, 13, 14, 16, 17, 18, 19
1130M	H1.5, H2, H2.5, H3, H4, H5, H6, H8, H10
1127R	T10H, T15H, T20H, T25H, T27H, T30H, T40H, T45H, T50H
601110R	782180OS

\*The guarantee is unlimited in time, excludes impact tools, and 1/4" screw bits.

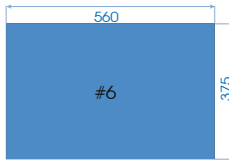
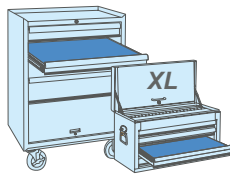

93 PC.

**92593MRE** (1/4") **1/4" #6** £229.62<sup>B</sup>

Contents 2.83

	2335M	3.2, 4, 4.5, 5, 5.5, 6, 7, 8, 9, 10, 11, 12, 13, 14
	2235M	4, 4.5, 5, 5.5, 6, 7, 8, 9, 10, 11, 12, 13, 14
	2375M	E4, E5, E6, E7, E8
	2275M	E4, E5, E6, E7, E8
	2035	H3, H4, H5, H6, H7, H8, H10
	2037	T8H, T9H, T10H, T15H, T20H, T30H, T40H
	2033	T8, T9, T10, T15, T20, T25, T27, T40
	1421	PH0 x 60, PH1 x 100, PH2 x 38, PH2 x 150, PH3 x 150
	1422	3 x 75, 5.5 x 100, 6.5 x 38, 6.5 x 150, 8 x 175
	1431	PH000 x 75, PH00 x 75, PH0 x 75, PH1 x 75
	1432	1.5 x 75, 2.0 x 75, 2.5 x 75, 3.0 x 75
		PH0 / 4, PH1 / 5, PH2 / 6, PH3 / 8
		H2 / H2.5, H3 / H4, H5 / H6
		T10 / T15
	2178DF	
	32810MR	
	275955G	
	222102, 222104, 222106	
	2792	
	2142	



92 PC.

**97392MRE** (1/4") (1/2") **#6** £372.91<sup>B</sup>

Contents 8.8

	2335M	5.5, 6, 7, 8, 9, 10, 11, 12, 13, 14
	4335M	10, 11, 12, 13, 14, 15, 16, 17, 18, 19, 21, 22, 24, 27, 30, 32
	4235M	8, 9, 10, 12, 13, 14, 15, 16, 17, 18, 19
	4375M	E10, E12, E14, E16, E18
	4033	T30, T40, T50, T55
	4049	M8, M9, M10, M12
	4036	M8, M10, M12
	4035	H6, H8, H10
	4026	M14
	402B	M16, M18
	1025H	H3, H4, H5, H6
	1025U	T7H, T8H, T9H, T10H, T15H, T20H, T25H, T27H, T30H, T40H
	1025Z	PZ1, PZ2, PZ3
	1025P	PH1, PH2, PH3
	97392MRE:	275955G 475910G
	97392MRE01:	277155G 477110G
	257145	2178DF 213312DF
	222102, 222104	425105R, 425110R
	2142	2745 2792 4791



84 PC.

**94584MRE01** (1/2") **#6** £479.71<sup>B</sup>

Contents 9.7

	4335M	8, 9, 10, 11, 12, 13, 14, 15, 16, 17, 18, 19, 20, 21, 22, 23, 24, 25, 26, 27, 28, 29, 30, 32, 33, 36
	4375M	E10, E12, E14, E16, E18, E20, E22, E24
	4025	H6, H7, H8, H10, H12, H14, H17
	4023	T20, T25, T27, T30, T40, T45, T50, T55, T60, T70
	4026	M5, M8, M10, M12, M14
	4027	T30, T40, T45, T50, T55, T60
	4035	H6, H7, H8, H10
	4033	T40, T45, T50, T55, T60, T70
	4036	M8, M10, M12
	402B	M16
	414808S, 414810S, 414810M	
	429305, 429310	
	477310GS	445318F 4791



14 PC.

**96314MRE01** (3/4") **#6** £310.61<sup>B</sup>

Contents 10.8

	6335M	33, 34, 35, 36, 38, 41, 46, 50
	677820FS	657220
	625104, 625108, 625116	6814

\* The guarantee is unlimited in time, excludes impact tools, measuring tools, power tools, pullers, wire brush, file and 1/4" screw bits.

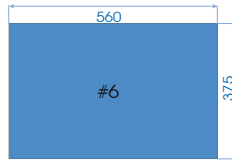
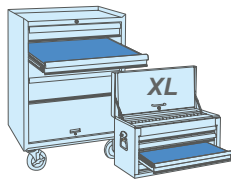

143 PC.

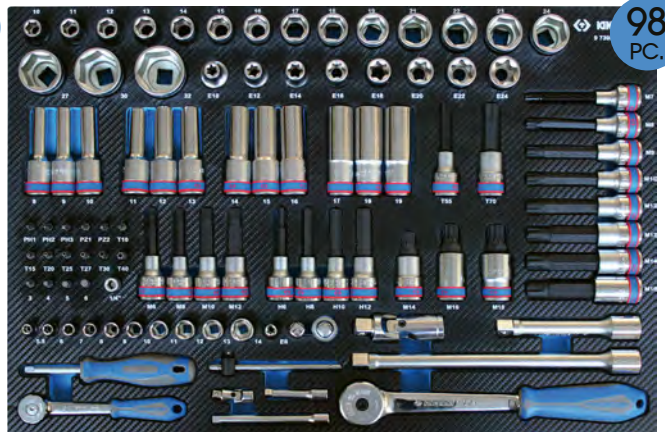

98 PC.

**97543MRV** (1/4") (1/2") #6 £301.71<sup>B</sup>

**97398MRE** (1/4") (3/8") (1/2") #6 £402.28<sup>B</sup>

Contents		5.65
2335M	4.5, 5.5, 6, 7, 8, 9, 10, 11, 12, 13, 14	
4335M	10, 11, 13, 14, 15, 16, 17, 18, 19, 20, 21, 22, 24, 27, 30, 32	
1636H	H4, H5, H6, H7, H8, H10, H12	
1636M	M5, M6, M8, M10, M12	
1636T	T20, T25, T27, T30, T40, T45, T50, T55, T60	
1680H	H4, H5, H6, H7, H8, H10, H12	
1680M	M5, M6, M8, M10, M12	
1680T	T20, T25, T27, T30, T40, T45, T50, T55, T60	
1120MR	H1.5, H2, H2.5, H3, H4, H5, H6, H8, H10	
1127R	T10H, T15H, T20H, T25H, T27H, T30H, T40H, T45H, T50H	
1025H	H3, H4, H5, H6	
1025S	3.0 x 0.5, 4.0 x 0.5, 5.0 x 0.8, 6.0 x 1.0	
1025U	T10H, T15H, T20H, T25H, T27H, T30H, T40H	
1025P	PH1, PH2 x 2 ø6mm, PH3	
1025T	T10, T15, T20, T25, T27, T30, T40	
1025Z	PZ1, PZ2 x 2, PZ3	
75363	770225	7909505M
797707	797807P02	425105R
457212	2792	2142
222302, 222304	2178DF	4791
477110G	277155G	414710M

Contents		8.8
2335M	5.5, 6, 7, 8, 9, 10, 11, 12, 13, 14	
4335M	10, 11, 12, 13, 14, 15, 16, 17, 18, 19, 21, 22, 23, 24, 27, 30, 32	
4235M	8, 9, 10, 11, 12, 13, 14, 15, 16, 17, 18, 19	
3375M	E8	
4375M	E10, E12, E14, E16, E18, E20, E22, E24	
4033	T55, T70	
4049	M7, M8, M9, M10, M12, M13, M14, M16	
4036	M6, M8, M10, M12	
4035	H6, H8, H10, H12	
4026	M14, M16, M18	
1025P	PH1, PH2, PH3	
1025H	H3, H4, H5, H6	
1025U	T10H, T15H, T20H, T25H, T27H, T30H, T40H	
1025Z	PZ1, PZ2	
275955G	475910G	
257145	2178DF	2142
222102, 222104	425105, 425110	
2792	4791	2813
		4813

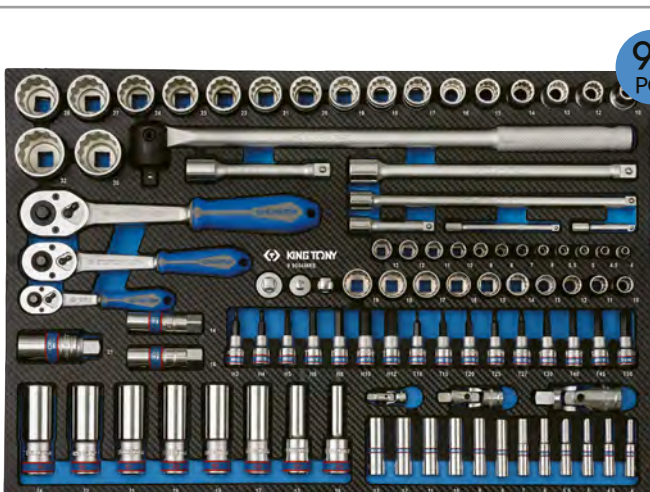

95 PC.

**99004MRE** (1/4") (3/8") (1/2") #6 £372.91<sup>B</sup>

Contents		8.1
2235M	4, 4.5, 5, 5.5, 6, 7, 8, 9, 10, 11, 12, 13	
3635	16, 21	
36A0	14	
2335M	4, 4.5, 5, 5.5, 6, 7, 8, 9, 10, 11, 12, 13	
3330M	10, 11, 12, 13, 14, 15, 16, 17, 18, 19	
4330M	10, 12, 13, 14, 15, 16, 17, 18, 19, 20, 21, 22, 23, 24, 27, 28, 30, 32	
4230M	10, 13, 17, 18, 19, 21, 22, 24	
3025	H3, H4, H5, H6, H8, H10, H12	
3023	T10, T15, T20, T25, T27, T30, T40, T45, T50	
277155G	377108G	477110GR
322103, 322110	222102, 222104	
425105, 425110	4791R	2792
3792	2813	3812
		4813
446218F		

\* The guarantee is unlimited in time, excludes impact tools, measuring tools, power tools, pullers, wire brush, file and 1/4" screw bits.

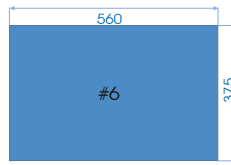
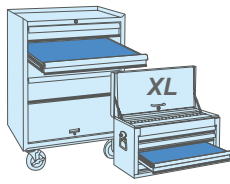

32  
PC.

990232MRE

**New**

#6

£245.64<sup>B</sup>

Contents

5.63

1062	6, 7, 8, 9, 10, 11, 12, 13, 14, 15, 16, 17, 18, 19, 20, 21, 22, 23, 24, 27, 30, 32
1900	8x9, 10x11, 12x13, 14x15, 16x17, 18x19, 20x22, 21x23, 24x27, 30x32

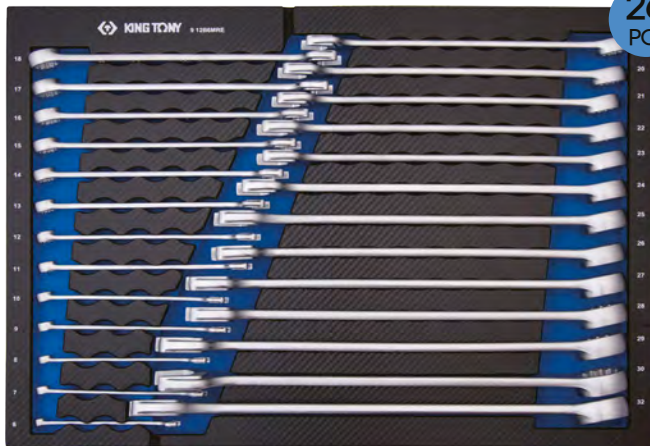

26  
PC.

912B6MRE

#6

£296.37<sup>B</sup>

Contents

5.9

1061	<b>XIL</b> 6, 7, 8, 9, 10, 11, 12, 13, 14, 15, 16, 17, 18, 19, 20, 21, 22, 23, 24, 25, 26, 27, 28, 29, 30, 32
------	---

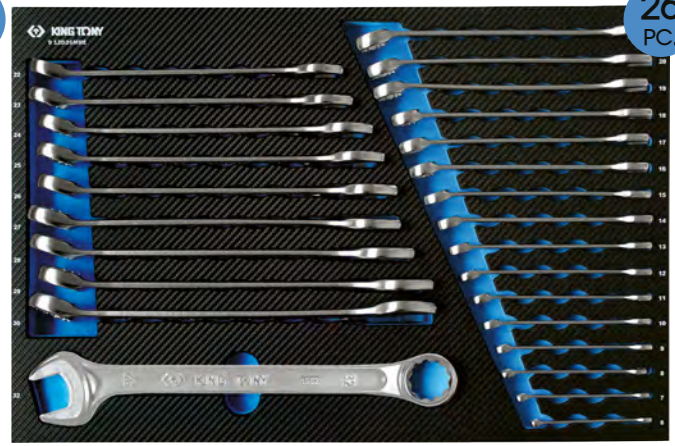

26  
PC.

912D26MRE

#6

£218.05<sup>B</sup>

Contents

5.9

1062	6, 7, 8, 9, 10, 11, 12, 13, 14, 15, 16, 17, 18, 19, 20, 21, 22, 23, 24, 25, 26, 27, 28, 29, 30, 32
------	--

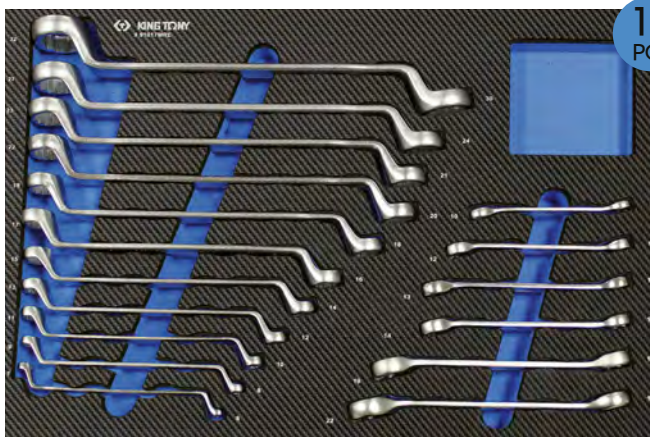

17  
PC.

991017MRE

#6

£168.21<sup>B</sup>

Contents

3.9

1970	6x7, 8x9, 10x11, 12x13, 14x15, 16x17, 18x19, 20x22, 21x23, 24x27, 30x32
1930	8x10, 10x12, 11x13, 12x14, 17x19, 19x22



15  
PC.

991215MRV

#6

£281.24<sup>B</sup>

Contents

2.5

1062	27, 28, 29, 30, 32	373AM	8, 10, 11, 13, 17, 19, 22, 24
	361112R		601110R

\* The guarantee is unlimited in time, excludes impact tools, measuring tools, power tools, pullers, wire brush, file and 1/4" screw bits.

Offer valid from 01/01/2026 to 31/12/2026. Recommended retail prices in pounds excl. taxes. Non-contractual photographs.

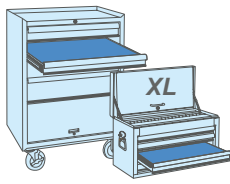

LIFETIME GUARANTEE\*

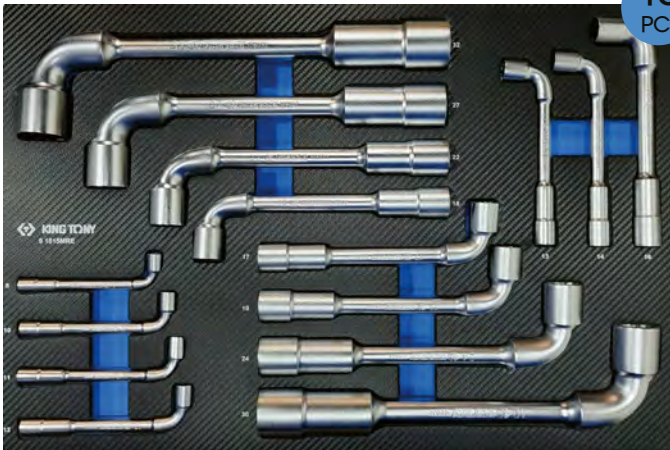
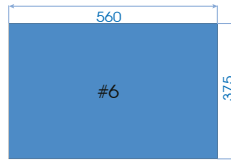

15 PC.

**91815MRE #6 £239.41<sup>B</sup>**

Contents	7.55
1080	8, 10, 11, 12, 13, 14, 16, 17, 18, 19, 22, 24, 27, 30, 32

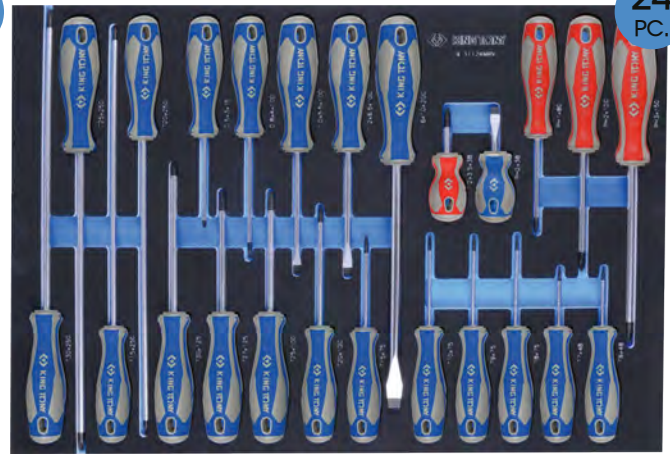

24 PC.

**93124MRV #6 £137.95<sup>B</sup>**

Contents	2.41
1421	PH2x38, PH1x80, PH2x100, PH3x150
1422	3x75, 4x100, 5.5x100, 6.5x100, 10x200, 6.5x38
1423	T6x48, T7x48, T8x75, T9x75, T10x75, T15x75, T15x250, T20x100, T20x250, T25x100, T25x250, T27x100, T30x125, T30x250



35 PC.

**991035CRV #6 £328.41<sup>B</sup>**

Contents	4.47
1421	PH1 x 100, PH2 x 38, PH3 x 150
1422	8 x 150, 5.5 x 100, 6.5 x 38
1062	6, 7, 8, 9, 10, 11, 12, 13, 14, 15, 16, 17, 18, 19, 21, 22, 24
7610405	7621706, 7622007, 7640306, 7640406, 7640565, 7640607
782130	651710C, 611108
631106	621106



19 PC.

**990319PRE #6 £132.61<sup>B</sup>**

Contents	2.44
1421	PH0 x 60
1422	3 x 75, 4 x 100, 5.5 x 150, 6.5 x 150, 8 x 175
1427	T10H x 75, T15H x 75, T20H x 100, T25H x 100, T27H x 100, T30H x 125, T40H x 150
1428	PZ1x100, PZ3x150
762G	22
764G	ø4, ø5, ø6

\* The guarantee is unlimited in time, excludes impact tools, measuring tools, power tools, pullers, wire brush, file and 1/4" screw bits.

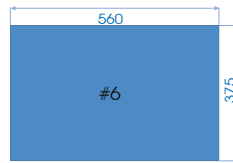
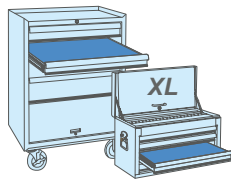

17 PC.

990217GRE03 #6 £230.51<sup>B</sup>

Contents		3, 4, 5, 6		kg 3.89	
764					
7610506	7671705	651710C	601110		
781116					
611108	623107	631108	631405		
66SB07	66HB07	66SS07	66HS07		



17 PC.

990217GRE04 #6 £230.51<sup>B</sup>

Contents		3, 4, 5, 6		kg 3.89	
764					
7610506	7671705	651710C	601110		
782150					
611108	623107	631108	631405		
66SB07	66HB07	66SS07	66HS07		



9 PC.

940209GPE #6 £210.04<sup>B</sup>

Contents		kg 2.72	
68HB07	68HS07	68SB07	
68SS07	651610A	611607A	
633608A	631808A	623607A	



11 PC.

990421GNE #6 £249.20<sup>B</sup>

Contents		kg 3.5	
68HB07	68HS07	68SB07	
68SS07	651610A	671606A	
633608A	623607A		
611209	672010	601110	

\* The guarantee is unlimited in time, excludes impact tools, measuring tools, power tools, pullers, wire brush, file and 1/4" screw bits.

Offer valid from 01/01/2026 to 31/12/2026. Recommended retail prices in pounds excl. taxes. Non-contractual photographs.

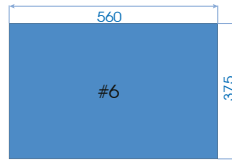
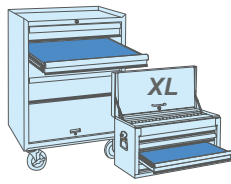

Available in March

10 PC.



940210GPV **New** #6 £220.72<sup>B</sup>

Contents kg 3.18

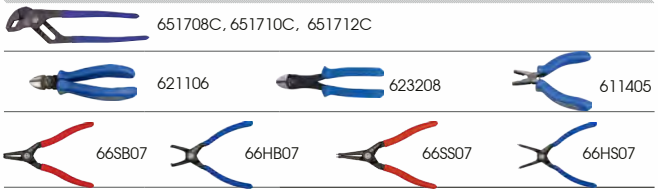

Available in March

11 PC.



990430TQV **New** #6 £218.05<sup>B</sup>

Contents kg 2.32

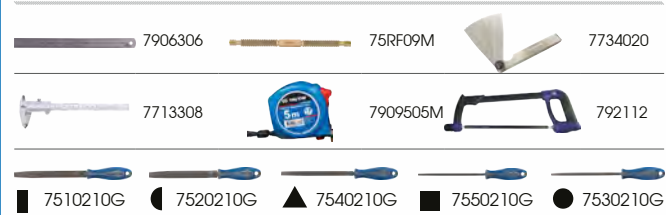

9 PC.



990409TQE #6 £126.38<sup>B</sup>

Contents kg 2.5

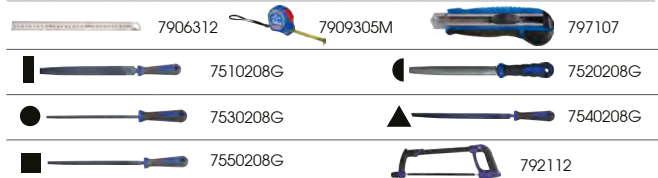

13 PC.



990413TQV #6 £140.62<sup>B</sup>

Contents kg 2.49

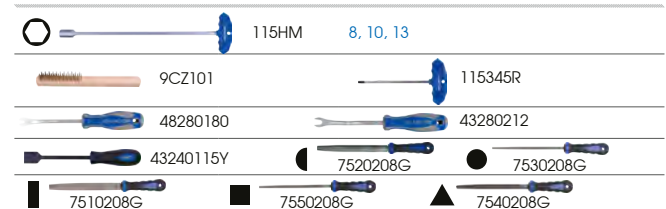

\* The guarantee is unlimited in time, excludes impact tools, measuring tools, power tools, pullers, wire brush, file and 1/4" screw bits.



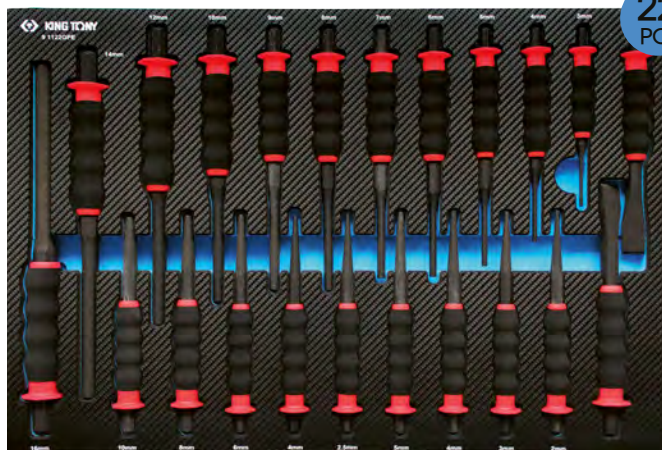
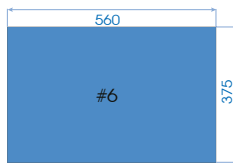
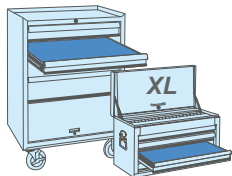

**91122GPE #6 £194.91<sup>B</sup>**

Contents		Weight
764G	ø3, ø4, ø5, ø6, ø7, ø8, ø9, ø10, ø12, ø14, ø16	4.75
762G	18, 22	
761G	ø2.5, ø4, ø6, ø8, ø10	
763G	ø2, ø3, ø4, ø5	



**91017GPE #6 £239.41<sup>B</sup>**

Contents		Weight
764G	ø3, ø4, ø5, ø6, ø8, ø10, ø12, ø14	6.5
762G	22	
761G	ø2.5, ø4, ø6, ø7, ø8	
762GR	26 x 7	
786238	784315	



**990408GQE #6 £262.55<sup>B</sup>**

Contents		Weight
762G	18, 22	2.35
9TK108, 9TK112	785116	
784310	782027	786238



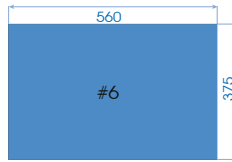
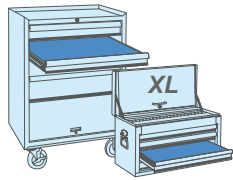

# ALLOY WHEELS SOCKETS

ANTI-MARKING ROTATING PLASTIC



19



**New**



10 PC.

Available in March

944910MPV **New** #6 £356 B

1/2"

Contents

5.73

4945M	15, 17, 19, 21, 22	98W4502	21
9BW4501	17	344621DG 40-200 Nm, 344623DG 20-100 Nm	
9BK11			



11 PC.



41 PC.

994411MQEU 1/2" #6 £248.31<sup>B</sup>

Contents

4.7

4945M	17, 19, 21	344231A (42-100 Nm)	9AE32110
34440A	9AE43	7713308	
159609	158609	6AB3175	

944803MPV 1/2" #6 £591.85<sup>B</sup>

Contents

9.5

4435M	10, 11, 12, 13, 14, 15, 16, 17, 18, 19, 21, 22, 24	426003P, 426005P	
4535M	10, 11, 12, 13, 14, 15, 16, 17, 18, 19, 21, 22, 24, 27, 30, 32	33481095	7990010, 3341171
4945M	17, 19, 21	344231A	4797P, SY211M x2

\* The guarantee is unlimited in time, excludes impact tools, measuring tools, power tools, pullers, wire brush, file and 1/4" screw bits.



IMPERIAL SIZE

**New** Available in March **87 PC.**



**99005SRV** **1/4"** **3/8"** **1/2"** **#6** **£333.75<sup>B</sup>**

Contents 8.10

○	2335S	5/32", 3/16", 7/32", 1/4", 9/32", 5/16", 11/32", 3/8", 7/16", 15/32", 1/2"			
○	2235S	5/32", 3/16", 7/32", 1/4", 9/32", 5/16", 11/32", 3/8", 7/16", 1/2"			
○	3330S	3/8", 7/16", 15/32", 1/2", 9/16", 19/32", 5/8", 11/16", 3/4"			
○	4230S	7/16", 1/2", 11/16", 3/4", 13/16", 7/8", 15/16"			
○	4330S	13/32", 7/16", 15/32", 1/2", 9/16", 19/32", 5/8", 11/16", 3/4", 25/32", 13/16", 1-1/16", 7/8", 15/16", 1", 1-3/16"			
○	3635	16, 21	○	36A0	14
●	3023	T10, T15, T20, T25, T27, T30, T40, T45, T50			
●	3025	H3, H4, H5, H6, H8, H10, H12			
—	322103, 322110	—	425105, 425110	—	3812
—	446218F	—	222102, 222104	—	2792
—	476210P	—	4791R	—	3792
—	376108P	—	276955P	—	2813



**40 PC.**

**99040SRV01** **#9** **£136.17<sup>B</sup>**

Contents 3.02

○	2330S	5/32", 3/16", 7/32", 1/4", 9/32", 5/16", 11/32", 3/8", 7/16", 1/2"
○	3330S	3/8", 7/16", 1/2", 9/16", 5/8"
○	4330S	3/8", 7/16", 1/2", 9/16", 5/8", 11/16", 3/4", 13/16", 7/8", 15/16", 1", 1-1/8", 1-1/4"
—	5060	1/4", 5/16", 3/8", 7/16", 1/2", 9/16", 5/8", 11/16", 3/4", 7/8", 15/16", 1"

**New** Available in March



**17 PC.**

**91217SRV** **#9** **£138.84<sup>B</sup>**

Contents 3.98

—	5060	1/4", 5/16", 3/8", 7/16", 1/2", 9/16", 5/8", 11/16", 3/4", 13/16", 7/8", 15/16", 1", 1-1/16", 1-1/8", 1-3/16", 1-1/4"
---	------	---

**New** Available in March



**11 PC.**

**94111SRV** **#7** **£67.64<sup>B</sup>**

Contents 1.31

●	4025S	3/16", 7/32", 1/4", 9/32", 1/2", 5/16", 11/16", 3/4", 13/16", 7/8", 15/16", 3/4"
---	-------	--



\* The guarantee is unlimited in time, excludes impact tools, measuring tools, power tools, pullers, wire brush, file and 1/4" screw bits.



82 PC.

**97582MRE** <sup>(1/4")</sup> #9 £134.39<sup>B</sup>

Contents		Weight
	2335M 4, 4.5, 5, 5.5, 6, 7, 8, 9, 10, 11, 12, 13	2.27
	2375M 4, 5, 6, 7, 8	
	1025H 3, 4, 5, 6	
	1025P PH1, PH2, PH3	
	1025U T7H, T8H, T9H, T10H, T15H, T20H, T25H, T27H, T30H, T40H	
	1025Z PZ1, PZ2, PZ3	
	1832H H3, H4, H5, H6, H7, H8, H10, H12	
	1832T T15, T20, T25, T27, T30, T40, T50	
	1636T T30, T40, T45, T50, T55, T60	
	1636H H5, H6, H7, H8, H10, H12	
	1836M M6, M8, M10, M12	
	1836S 11 x 2.0, 9 x 1.6	
	1836P PH2, PH3	
	275955G	
	257145	
	245205F	
	2792	
	2142	
	4112	
	222102, 222104	
	2177DF	



62 PC.

**92562MRE01** <sup>(1/4")</sup> #9 £126.38<sup>B</sup>

Contents		Weight
	2335M 3, 2, 4, 5, 5.5, 6, 7, 8, 9, 10, 11, 12, 13, 14	1.6
	2235M 4, 4.5, 5, 5.5, 6, 7, 8, 9, 10, 11, 12, 13, 14	
	1025P PH1, PH2, PH3	
	1025S 3, 4, 5, 6	
	1025H H3, H4, H5, H6	
	1025Z PZ1, PZ2, PZ3	
	1025T T10, T15, T20, T25, T27, T30, T40	
	1025U T10H, T15H, T20H, T25H, T27H, T30H, T40H	
	277355GS	
	278106P	
	213312DF	
	2178DF	
	75260	
	770225	
	2792	
	2142	
	2813	

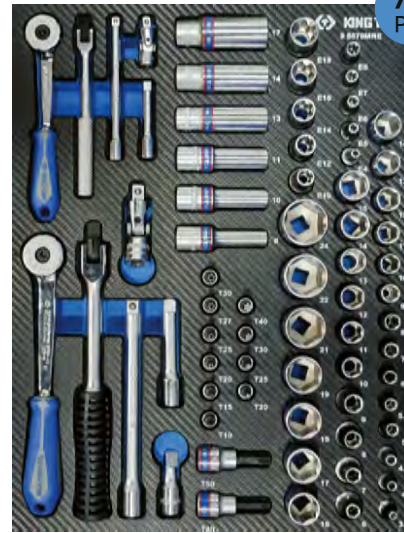

70 PC.

**95570MRE** #9 £185.12<sup>B</sup>

Contents		Weight
	2335M 3, 2, 4, 4.5, 5, 5.5, 6, 7, 8, 9, 10, 11, 12, 13, 14	3.2
	3335M 6, 7, 8, 9, 10, 11, 12, 13, 14, 15, 16, 17, 18, 19, 21, 22, 24	
	3235M 8, 10, 11, 12, 14, 17	
	2375M E4, E5, E6, E7, E8	
	3375M E10, E12, E14, E16, E18	
	2033 T20, T25, T30, T40	
	2037 T10H, T15H, T20H, T25H, T27H, T30H	
	3027 T40H, T50H	
	275955G	
	375908G	
	245205F	
	345208G	
	2792	
	222102, 222104	
	322116, 322103, 322106	
	3792	



44 PC.

**93544MRV** <sup>(3/8")</sup> #9 £173.55<sup>B</sup>

Contents		Weight
	3335M 10, 11, 12, 13, 14, 15, 16, 17, 18, 19, 20, 21, 22	3.19
	3375M E7, E8, E10, E11, E12	
	3230M 8, 10, 11, 12, 13, 14, 16, 17, 19	
	3750M 10, 11, 12, 13, 14, 15, 16, 17, 18, 19	
	377908G	
	3812, 3814	
	322314	
	322103, 322106, 322110	

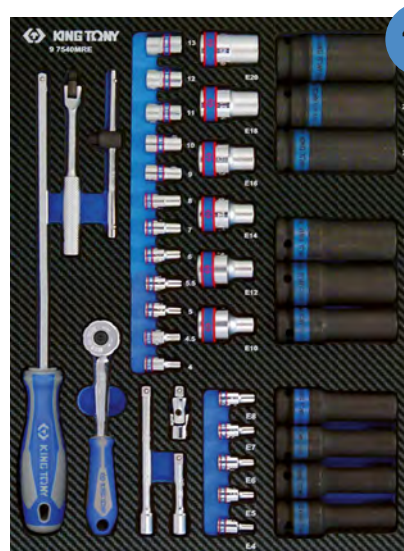

40 PC.

**97540MRE** #9 £148.63<sup>B</sup>

Contents		Weight
	2335M 4, 4.5, 5, 5.5, 6, 7, 8, 9, 10, 11, 12, 13	3.36
	2375M E4, E5, E6, E7, E8	
	4375M E10, E12, E14, E16, E18, E20	
	4435M 10, 11, 12, 13, 14, 17, 19, 21, 22, 24	
	275955G	
	2792	
	2177NU	
	257145	
	245205F	
	222102, 222104	

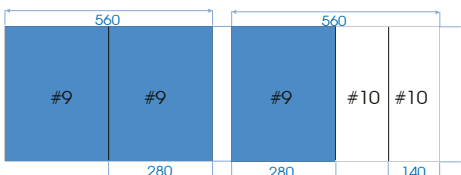
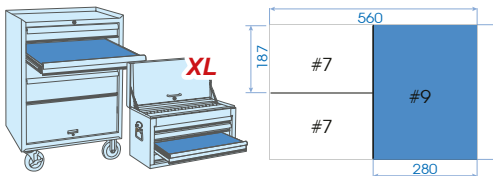
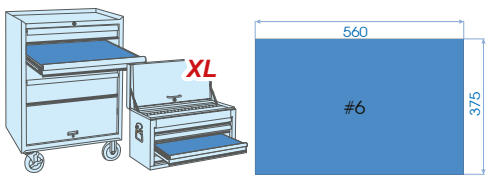

\* The guarantee is unlimited in time, excludes impact tools, measuring tools, power tools, pullers, wire brush, file and 1/4" screw bits.

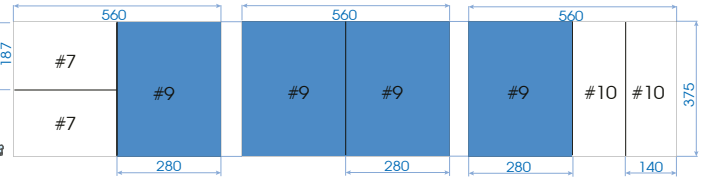
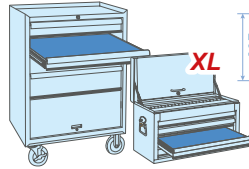
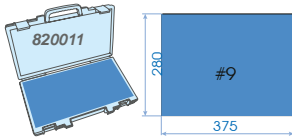

60 PC.

97560MRV01 #9 £203.81<sup>B</sup>

Contents		Weight
2335M	4.5, 5.5, 6, 7, 8, 9, 10, 11, 12, 13, 14	6.24
4335M	10, 11, 13, 14, 15, 16, 17, 18, 19, 20, 21, 22, 24, 27, 30, 32	
1025S	3.0, 4.5, 5, 6.5, 83.0, 4.5, 5, 6.5, 8	
1025P	PH0, PH1, PH2, PH3	
1025U	T10H, T15H, T20H, T25H, T27H, T30H, T40H	
1025Z	PZ1, PZ2, PZ3	
276A04G	477110GR	445215FR
457212	213312DF	2792
4791R	2813	2745
222302, 222304	425105R, 425110R	

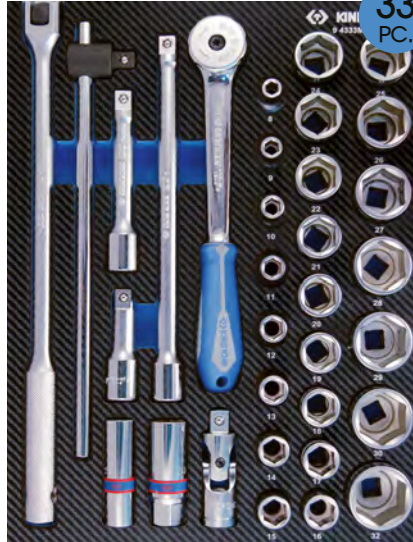

33 PC.

94333MRE 1/2" #9 £174.44<sup>B</sup>

Contents		Weight
4335M	8, 9, 10, 11, 12, 13, 14, 15, 16, 17, 18, 19, 20, 21, 22, 23, 24, 25, 26, 27, 28, 29, 30, 32	5.3
463516M, 463521R		
475910G	457212	
445215F	4791	
425103, 425105, 425110		



37 PC.

94537MRV 1/2" #9 £177.11<sup>B</sup>

Contents		Weight
4335M	8, 10, 11, 12, 13, 14, 15, 16, 17, 18, 19, 20, 21, 22, 23, 24, 26, 27, 28, 30, 32	4.39
4375M	E10, E12, E14, E16, E18, E20, E22, E24	
463516R, 463521R		
463014RC		
477910GR	4791	
429302	425105R, 425110R	



21 PC.

94221MRV 1/2" #9 £165.54<sup>B</sup>

Contents		Weight
4230M	8, 9, 10, 11, 12, 13, 14, 15, 16, 17, 18, 19, 21, 22, 24, 27, 30, 32, 33, 34, 36	3.92

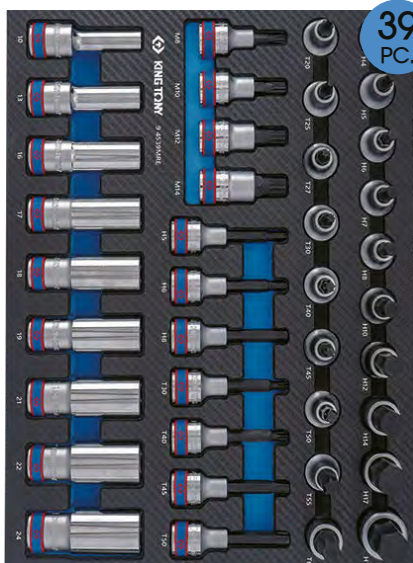

39 PC.

94539MRE 1/2" #9 £201.14<sup>B</sup>

Contents		Weight
4235M	10, 13, 16, 17, 18, 19, 21, 22, 24	5.26
4023	T20, T25, T27, T30, T40, T45, T50, T55, T60	
4025	H4, H5, H6, H7, H8, H10, H12, H14, H17, H19	
4026	M8, M10, M12, M14	
4033	T30, T40, T45, T50	
4035	H5, H6, H8	



19 PC.

94419MPE 1/2" #9 £177.11<sup>B</sup>

Contents		Weight
4435M	10, 11, 12, 13, 14, 15, 16, 17, 18, 19, 21, 22, 24, 27, 30, 32, 33, 34, 36	5.6

\* The guarantee is unlimited in time, excludes impact tools, measuring tools, power tools, pullers, wire brush, file and 1/4" screw bits.

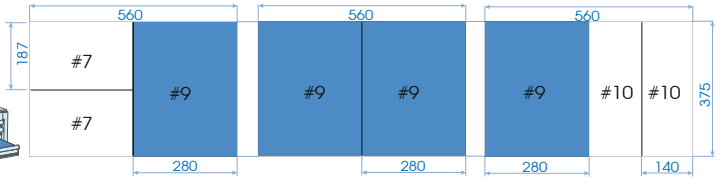
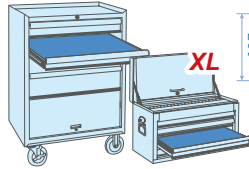
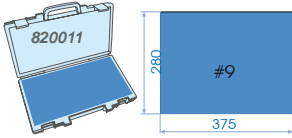

20 PC.

**91220MRV #9** £138.84<sup>B</sup>

Contents 3.49

1060 6, 7, 8, 9, 10, 11, 12, 13, 14, 15, 16, 17, 18, 19, 21, 22, 24, 27, 30, 32



16 PC.

**912D16MRE1 #9** £123.71<sup>B</sup>

Contents 3.3

1062 6, 8, 10, 11, 13, 14, 16, 17, 18, 19, 21, 22, 24, 27, 30, 32



12 PC.

**91112MRE #9** £94.34<sup>B</sup>

Contents 2.6

1900 6x7, 8x9, 10x11, 12x13, 14x15, 16x17, 18x19, 20x22, 21x23, 24x27, 25x28, 30x32



20 PC.

**912D20MRE #9** £141.51<sup>B</sup>

Contents 2.6

1062 6, 7, 8, 9, 10, 11, 12, 13, 14, 15, 16, 17, 18, 19, 21, 22, 24, 27, 30, 32



19 PC.

**912D19MRE1 #9** £111.25<sup>B</sup>

Contents 2.5

1062 6, 7, 8, 9, 10, 11, 12, 13, 14, 15, 16, 17, 18, 19, 20, 21, 22, 23, 24



5 PC.

**912D05MRE #9** £86.33<sup>B</sup>

Contents 2.6

1062 27, 28, 29, 30, 32



1062 I-beam

\* The guarantee is unlimited in time, excludes impact tools, measuring tools, power tools, pullers, wire brush, file and 1/4" screw bits.

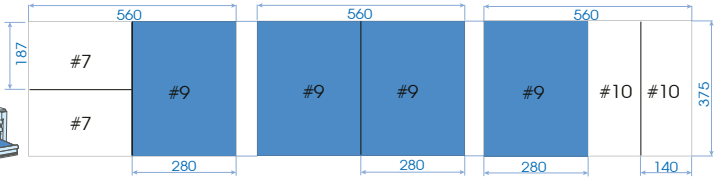
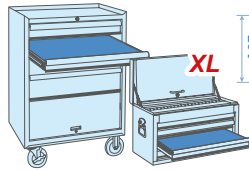
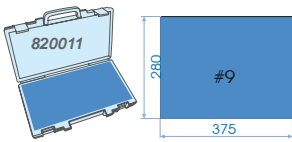

**9122A08MRE #9** £168.21<sup>B</sup>

Contents

1.6

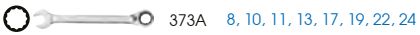

373A 8, 10, 11, 13, 17, 19, 22, 24



**9122A14MRE #9** £251.87<sup>B</sup>

Contents

2.36

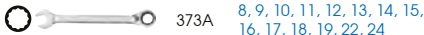

373A 8, 9, 10, 11, 12, 13, 14, 15, 16, 17, 18, 19, 22, 24



**990221MRE01 #9** £132.61<sup>B</sup>

Contents

1.94

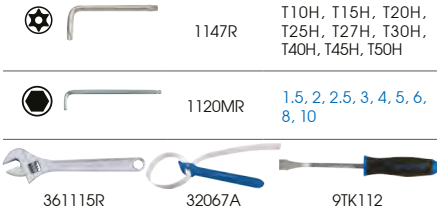

**373AM** **Anti-slip ring**

- With its anti-slip ring, it will not slip off the fastener head.
- You'll work faster, and increase productivity and safety

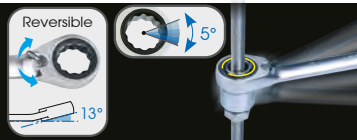

**New** Available in March



**990210TQV #9** £250.09<sup>B</sup>

Contents

1.20



**991107MRE01 #9** £230.51<sup>B</sup>

Contents

1.1

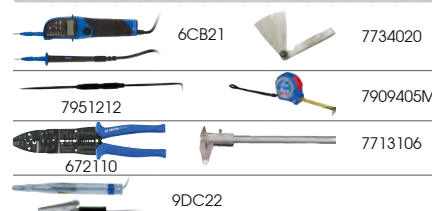

**990407GQE #9** £141.51<sup>B</sup>

Contents

1.2



\* The guarantee is unlimited in time, excludes impact tools, measuring tools, power tools, pullers, wire brush, file and 1/4" screw bits.

Offer valid from 01/01/2026 to 31/12/2026. Recommended retail prices in pounds excl. taxes. Non-contractual photographs.

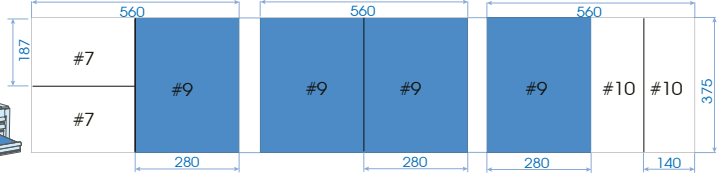
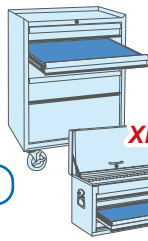
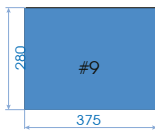

LIFETIME GUARANTEE\*

**New** Available in March



90 PC.

**991190CRV #9 £150.41<sup>B</sup>**

Contents 2.22

	1025S	3.0, 4.0, 5.0, 6.0
	1025P	PH1, PH2 x 2, PH3
	1025Z	PZ1, PZ2 x 2, PZ3
	1025T	T10, T15, T20, T25, T27, T30, T40
	1025H	H3, H4, H5, H6
	1025U	T10H, T15H, T20H, T25H, T27H, T30H, T40H
	1025R	RB2
	770225	75363
	10DD	10, 12, 13, 14, 17, 18, 19
	1130MR	H2.5, H3, H4, H5, H6, H8, H10
	1130SR	3/32", 1/8", 5/32", 3/16", 1/4", 5/16", 3/8"
	1147R	T10H, T15H, T20H, T25H, T27H, T30H, T40H
	361106R, 361108R	
	7732826	
	276A04G	



61 PC.

**991161CQE #9 £113.92<sup>B</sup>**

Contents 1.4

	1636H	H4, H5, H6, H7, H8, H10, H12
	1636T	T20, T25, T27, T30, T40, T45, T50, T55, T60
	1636M	M5, M6, M8, M10, M12
	1680H	H4, H5, H6, H7, H8, H10, H12
	1680T	T20, T25, T27, T30, T40, T45, T50, T55, T60
	1680M	M5, M6, M8, M10, M12
	1127R	T10H, T15H, T20H, T25H, T27H, T30H, T40H, T45H, T50H
	1120MR	H1.5, H2, H2.5, H3, H4, H5, H6, H8, H10
	414710M	



22 PC.

**990222MRE #9 £128.16<sup>B</sup>**

Contents 1.94

	1120MR	H1.5, H2, H2.5, H3, H4, H5, H6, H7, H8
	1147R	T10, T15, T20, T25, T27, T30, T40, T45, T50
	651710C	
	611108 (990222MRE) / 611107 (990222MRE01)	631106 / 621106

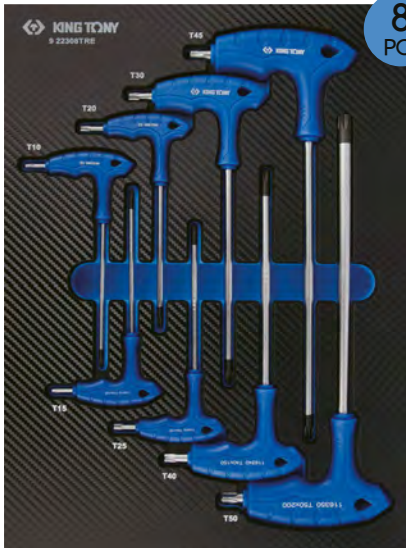

8 PC.

**922308TRE #9 £64.97<sup>B</sup>**

Contents 1.1

	1163TR	T10, T15, T20, T25, T30, T40, T45, T50
--	--------	--



9 PC.

**91019GRE #9 £79.21<sup>B</sup>**

Contents 1.7

	764G	Ø 2, Ø 3, Ø 4, Ø 5, Ø 6, Ø 8
	762G	18, 22
	9TK112	

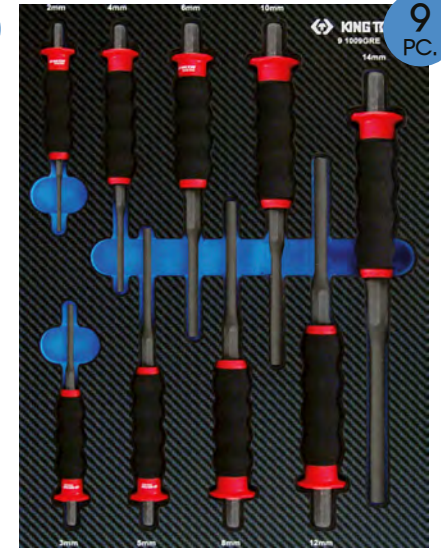

9 PC.

**91009GPE #9 £88.11<sup>B</sup>**

Contents 2.0

	764G	Ø 2, Ø 3, Ø 4, Ø 5, Ø 6, Ø 8, Ø 10, Ø 12, Ø 14
--	------	--

\* The guarantee is unlimited in time, excludes impact tools, measuring tools, power tools, pullers, wire brush, file and 1/4" screw bits.



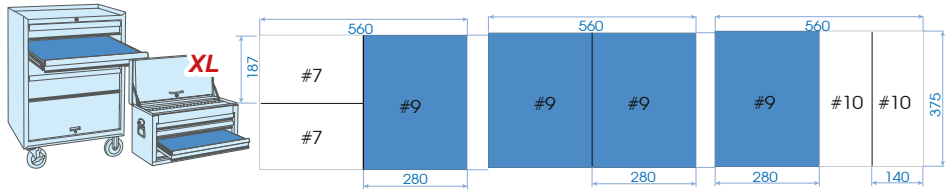
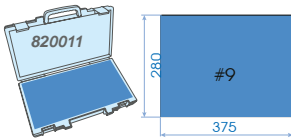

31 PC.

990131MRE #9 £145.07<sup>B</sup>

Contents		1/2"	3.1
	4033	T20, T25, T27, T30, T40, T45, T50, T55, T60	
	4035	H4, H5, H6, H7, H8, H10, H12, H14, H17	
	1120MR	H1.5, H2, H2.5, H3, H4, H5, H6, H8, H10	
	1930	10 x 11, 12 x 14, 14 x 17	
	3204	Ø 60 ~ 140	



5 PC.

91905MRE #9 £91.67<sup>B</sup>

Contents		0.82
	1950	10 x 12, 11 x 13, 14 x 17, 16 x 18, 19 x 22



25 PC.

94435MP #9 £192.24<sup>B</sup>

Contents		1/2"	7.3
	4435M	8, 9, 10, 11, 12, 13, 14, 15, 16, 17, 18, 19, 20, 21, 22, 23, 24, 25, 26, 27, 28, 29, 30, 32, 36	

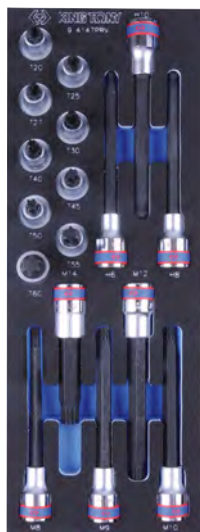

17 PC.

94147PRV 1/2" #10 £129.05<sup>B</sup>

Contents		1.81
	40D0	H6, H8, H10
	4066	M8, M9, M10, M12, M14
	4023	T20, T25, T27, T30, T40 T45, T50, T55, T60



121 PC.

9212007MRV #10 £47.17<sup>B</sup>

Contents		0.91
	2120101	4.8 x 10, 4.8 x 8, 4 x 10, 4 x 8



4 PC.

942154GPV #10 £68.53<sup>B</sup>

Contents		0.8
	66HS07	66HB07
	66SB07	66SS07

\* The guarantee is unlimited in time, excludes impact tools, measuring tools, power tools, pullers, wire brush, file and 1/4" screw bits.

Offer valid from 01/01/2026 to 31/12/2026. Recommended retail prices in pounds excl. taxes. Non-contractual photographs.

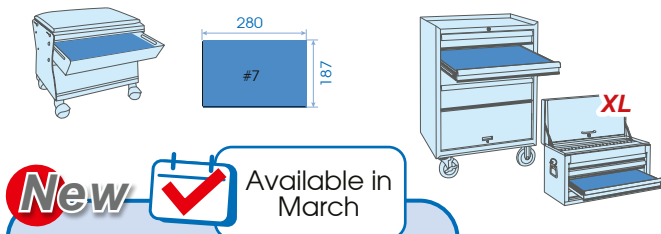

**New** Available in March

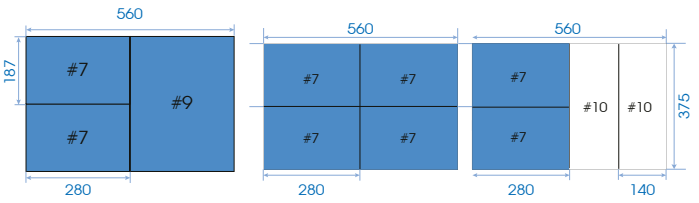

11 PC.

**94113PRV #7 £72.98<sup>B</sup>**

Contents 1.39

- 4025 H3, H4, H5, H6, H7, H8, H9, H10, H11, H12, H14, H17, H19



12 PC.

**910112MRE #7 £145.07<sup>B</sup>**

Contents 1.13

- 3731M 10, 11, 12, 13, 14, 15, 16, 17, 19

- 373202R 373203R 373204R



6 PC.

**91306MRE #7 £55.18<sup>B</sup>**

Contents 1.0

- 1930 8x10, 10x12, 11x13, 12x14, 17x19, 19x22

SET MODULE



27 PC.

**94427MP 1/2" #7 £138.84<sup>B</sup>**

Contents 4.09

- 4535M 8, 9, 10, 11, 12, 13, 14, 15, 16, 17, 18, 19, 20, 21, 22, 23, 24, 25, 26, 27, 28, 29, 30, 32, 33, 34, 36

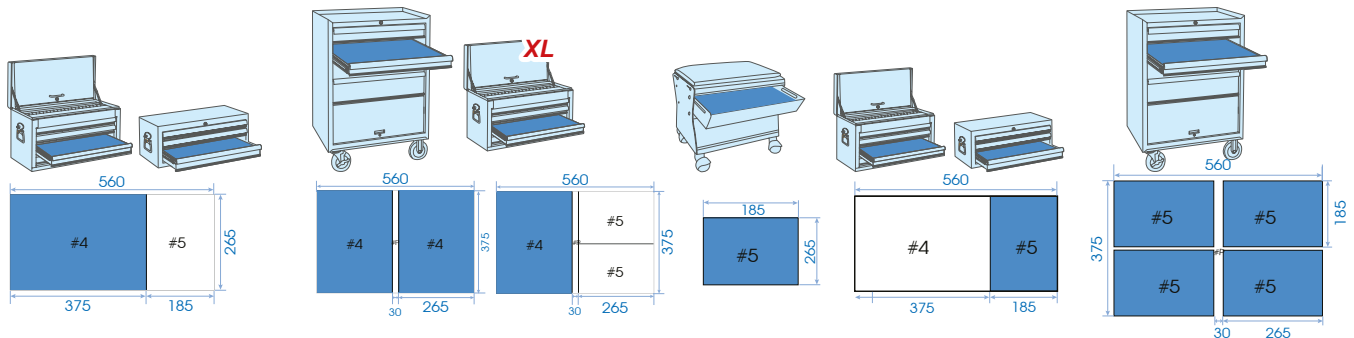

12 PC.

**9102A12MR #5 £177.11<sup>B</sup>**

Contents 1.22

- 373AM 10, 11, 12, 13, 14, 15, 16, 17, 19

- 373202R 373204R 373203R



15 PC.

**9102A15MR #4 £230.51<sup>B</sup>**

Contents 1.9

- 373A 8, 9, 10, 11, 12, 13, 14, 15, 16, 17, 19, 22

- 373202R 373204R 373203R

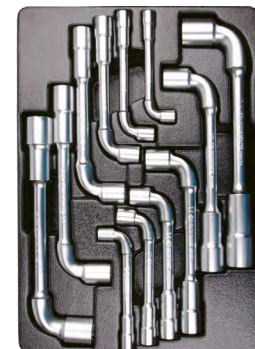

12 PC.

**91912MR #4 £103.24<sup>B</sup>**

Contents 3.69

- 1081 8, 10, 11, 12, 13, 14, 16, 17, 18, 19, 22, 24

\* The guarantee is unlimited in time, excludes impact tools, measuring tools, power tools, pullers, wire brush, file and 1/4" screw bits.



# TORQUE CONTROL

**62**  
SERIES

TOLERANCE  
+/- 3%



## 34\_62\_DG

### HEAVY DUTY ADJUSTABLE TORQUE WRENCH

DIN ISO 6789 & ASME B107.300-2010.  
Designed for an easy torque adjustment.  
±3% torque accuracy (clockwise).  
Clockwise (CW) and counter-clockwise (CCW) triggering.

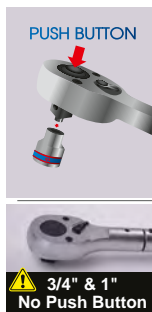

	Square drive	Torque range Nm	Graduation	Number of teeth	Total length mm	kg	
342621DG	1/4"	4-20 Nm	0.1 Nm	24	324	0.64	£113.92 B
342622DG	1/4"	2-10 Nm	0.1 Nm	24	281	0.56	£97.01 B
342623DG	1/4"	5-30 Nm	0.5 Nm	24	325	0.64	£105.91 B
343621DG	3/8"	4-20 Nm	0.1 Nm	32	324	0.64	£102.35 B
343622DG	3/8"	20-100 Nm	0.5 Nm	32	435	1.30	£119.26 B
343623DG	3/8"	10-60 Nm	0.5 Nm	32	325	1.30	£113.03 B
344621DG	1/2"	40-200 Nm	1 Nm	32	521	1.59	£123.71 B
344622DG	1/2"	60-340 Nm	2 Nm	32	613	1.81	£123.71 B
344623DG	1/2"	20-100 Nm	1 Nm	32	435	1.30	£122.82 B
344624DG	1/2"	80-400 Nm	2 Nm	32	613	1.97	£121.04 B
346621DG	3/4"	100-600 Nm	5 Nm	24	1048	5.50	£364.01 B
346622DG	3/4"	150-800 Nm	5 Nm	24	1234	5.60	£453.01 B
346623DG	3/4"	200-1000 Nm	5 Nm	24	1238	6.15	£479.71 B
348621DG	1"	200-1000 Nm	5 Nm	24	1238	6.15	£488.61 B

**62**  
SERIES

TOLERANCE  
+/- 3%



## 348622DG

1" £800.11 B

⚠ This torque wrench must be used with its extension.  
Not using it will result in inaccurate torque or damage.

### HEAVY DUTY ADJUSTABLE TORQUE WRENCH

DIN ISO 6789 & ASME B107.300-2010. Designed for an easy torque adjustment. ±3% torque accuracy (clockwise).  
Clockwise (CW) and counter-clockwise (CCW) triggering.

	Square drive	Torque range Nm	Graduation	Total length mm	kg
348622DG	1"	300-1500 Nm	10 Nm	1850	12.2

**6A**  
SERIES

TOLERANCE  
+/- 3%

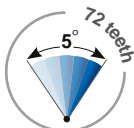

### HEAVY DUTY ADJUSTABLE TORQUE WRENCH

DIN ISO 6789 & ASME B107.300-2010.  
Quick release button design.  
Fixed head version, allowing to operate in reduced spaces.  
5° Gear action degree (72 teeth).  
Torque accuracy tolerance +3% (CW). Clockwise (CW) and counter-clockwise (CCW) triggering.

	Square drive	Torque range Nm	Graduation	Total length mm	kg	
3436A2DG	3/8"	20-100 Nm	0.5 Nm	430	1.30	£136.17 B
3446A1DG	1/2"	40-200 Nm	1 Nm	490	1.46	£137.06 B
3446A2DG	1/2"	60-340 Nm	2 Nm	590	1.75	£135.28 B

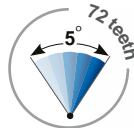

**3426D1DA**

**ALUMINIUM MINI TORQUE WRENCH FOR BICYCLES**

DIN ISO 6789 & ASME B107.300-2010.  
Quick release button design.  
Fixed head version, allowing to operate in reduced spaces.  
5° Gear action degree (72 teeth).  
Torque accuracy tolerance +4% (CW).  
Clockwise (CW) and counter-clockwise (CCW) triggering.



	Square drive	Torque range Nm	Graduation	Total length mm	kg	
3426D1DA	1/4"	3 - 16 Nm	0.1 Nm	172	214	£114.81 <sup>B</sup>

**3426D1D23MR**

1/4"

£129.05<sup>B</sup>

**MINI ADJUSTABLE TORQUE WRENCH AND SCREW BITS SET**

199 x 161 x 56 mm



23 PC.

Contents

kg 0.72

	3426D1DA	3~16 Nm
	1025S	3, 4, 5, 5.5, 6
	1025P	PH0, PH1, PH2, PH3
	1025H	H3, H4, H5, H6, H8, H10
	1025T	T10, T15, T20, T25, T30
	2142	
	222104	



**SWITCH SERIES**

TOLERANCE +/- 3%



Quick automatic return adjustment



Comfortable rubber handle

**PUSH**  
to remove the insert tool easily



**345\_DG**

**HEAVY DUTY INTERCHANGEABLE TORQUE WRENCHES**

Compatible with standard insert tools. Quality in accordance with DIN ISO 6789 & ASME B107.300-2010.  
Torque accuracy tolerance +3% (CW) CW/CCW Direction.

	Size mm	Torque range Nm	Graduation	Total length mm	kg	
345121DG	9 x 12	2-10 Nm	0.1 Nm	261	0.51	£89.00 <sup>B</sup>
345122DG	9 x 12	4-20 Nm	0.1 Nm	306	0.59	£89.00 <sup>B</sup>
345123DG	9 x 12	20-100 Nm	0.5 Nm	430	1.27	£108.58 <sup>B</sup>
345223DG	14 x 18	60-340 Nm	2 Nm	580	1.59	£123.71 <sup>B</sup>
345224DG	14 x 18	100-600 Nm	5 Nm	1015	6.20	£337.31 <sup>B</sup>
345226DG	14 x 18	150-800 Nm	5 Nm	1195	6.62	£346.21 <sup>B</sup>
345227DG	14 x 18	70-350 Nm	2 Nm	580	1.80	£123.71 <sup>B</sup>
345228DG	14 x 18	200-1000 Nm	5 Nm	1200	6.62	£372.91 <sup>B</sup>
345229DG	14 x 18	80-400 Nm	2 Nm	580	1.78	£123.71 <sup>B</sup>



TOLERANCE +/- 2%



585

**346071A** 3/4" £146.85<sup>B</sup>

**ELECTRONIC TORQUE ADAPTOR**

Direct reading of the torque on the LCD display. Easy torque input. Audio and visual alarm when reaching the desired torque setting. Battery life: 110 hours.

Torque range

	Square drive	Nm	Incr.	ft.lb	kgf.m	Memory
<b>346071A</b>	3/4"	200-1000 Nm	0.1 Nm	147.6-738 ft.lb	20.4-102 kgf.m	50

Make sure to check the torque first

10 PC.



**1E10MR** 3/8" £83.66<sup>B</sup>

**3/8" CROWFOOT INSERT SET ON RAIL**

Crowfoot inserts. 12 points flare nut. For difficult access.

Contents

550

1031R 10, 11, 12, 13, 14, 15, 16, 17, 18, 19 mm

Also available in 1/2" and 3/4" lengths  
**22** 50 mm



TOLERANCE +/- 5%

Rotary angle gauge

173 Nm max. 1/2"



4500 Nm max. 1"



8.9

**3448826** 26:1 £1,584.20<sup>B</sup>

**26:1 TORQUE MULTIPLIER**

Accuracy: ±5% at least. Anti-backlash. 2 types of reaction bar (straight and angled).



Use with impact socket. Do not use with a power tool (impact wrench....). Do not use an extension bar.

New

TOLERANCE +/- 5%

300 Nm max. 1/2"



1500 Nm max. 3/4"



7.1

**34486** 5:1 £469.03<sup>B</sup>

**5:1 TORQUE MULTIPLIER**

Accuracy: ±5% at least. 2 types of reaction bar (straight and angled).

540 Nm max. 3/4"



2700 Nm max. 1"

7.4

**34688** 5:1 £489.50<sup>B</sup>



TOLERANCE +/- 2%

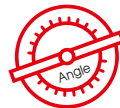

**344171A** 1/2" £150.41<sup>B</sup>

**ANGLE TORQUE ADAPTER**

Contents: torque and angle adapter, 1 control adapter, one 1/2" x 1/4" adapter and one 1/2" x 3/8" adapter.

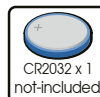

	Square drive	Nm	Incr.	ft.lb	kgf.m	Memory
<b>344171A</b>	1/2"	40-200 Nm	0.1 Nm	29.5-147.5 ft.lb	4.08-20.38 kgf.m	10

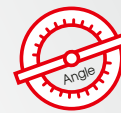

Flexible and magnetic arm for better adjustment against components.



375

**34440A** 1/2" £32.93<sup>B</sup>

**TORQUE ANGLE GAUGE**

The dial allows the operator to precisely tighten to the desired angle. Transparent composite plate with integrated pointer, 360° angle scale clearly marked in 2° increments, and in intervals of 10° and 30°, protecting the dial from dirt and grease.

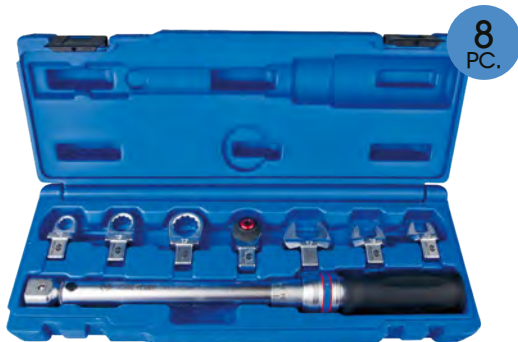

8 PC.

328 x 123 x 60 mm

**345102D08MR**

£183.34<sup>B</sup>

**INTERCHANGEABLE TORQUE WRENCH SET (4~20 NM)**

Plastic box. Inserts 9x12mm.

Contents		⚖️ 1.3
	345011M 10, 13, 17	
	345021M 10, 13, 17	
	1/4" 34503102R	
	345122DG	



11 PC.

618 x 153 x 65 mm

**345202D11MR**

£291.03<sup>B</sup>

**345203D11MR**

£308.83<sup>B</sup>

**INTERCHANGEABLE TORQUE WRENCH SET (40~200 NM)**

Plastic box. Inserts 14x18mm.

Contents		⚖️ 3.8
	345202D11MR	345222DG
	345203D11MR	345223DG
	345012M 13, 14, 15, 17, 19, 22, 24, 27, 30 mm	
	1/2" 34503204R	

**INTERCHANGEABLE TORQUE WRENCH SET (60~340 NM)**

⚖️ 4.0



TOLERANCE +/- 5%

Suitable for 1/4" Hex insert bit



Set torque using the blue band

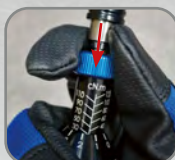

**34011\_DG**

1/4"

**TORQUE SCREWDRIVER**

DIN ISO 6789 & ASME B107.300-2010. Easy-to-read laser scale. Ergonomic and comfortable rubber grip. Aluminium alloy.

	○	Torque range	Incr.	Length	⚖️	
		cNm / Nm		mm		
<b>34011DG</b>	1/4"	30~120 cNm	1 cNm	180	207	£114.81 <sup>B</sup>
<b>34012DG</b>	1/4"	1.5 - 6.5 Nm	0.1 Nm	196	475	£119.26 <sup>B</sup>



TOLERANCE +/- 5%

Equipped with a 1/4"



**342113DG**

1/4"

£124.60<sup>B</sup>

**1/4" SOCKET HOLDER TORQUE SCREWDRIVER**

DIN ISO 6789 & ASME B107.300-2010. Accuracy ±5%. Equipped with a 1/4. Direct reading of torque measure. Delivered with a calibration certificate. Adjust torque using the blue ring. Aluminium alloy frame. Comfortable ergonomic handle. Easy-to-read laser scale.



	1/4"DR.	Torque range	Incr.	Length	⚖️
		Nm		mm	
<b>342113DG</b>	○	4 ~ 9 Nm	0.1 Nm	196	475

# PULLERS



## 7962B

### 2 ARMS UNIVERSAL PULLER

Exchangeable and adjustable sliding arms. Fast and precise tightening.

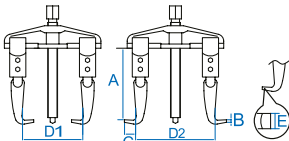

	Power Tons	A mm	B mm	C mm	D1 mm	D2 mm	E mm	mm	kg	£
7962B35	3 T	100	3.8	14.5	90	60-125	21	17	1.05	£66.75 <sup>B</sup>
7962B05	5 T	100	3.8	14.5	130	60-160	21	17	1.15	£70.31 <sup>B</sup>
7962B06	5 T	150	4.6	23	150	85-200	30	22	2.98	£112.14 <sup>B</sup>
7962B08	7.5 T	150	4.6	23	190	105-230	30	22	3.41	£129.05 <sup>B</sup>
7962B10	7.5 T	210	7.0	30	240	130-300	35	27	7.11	£218.05 <sup>B</sup>



## 7963

### PULLER WITH 3 ARTICULATED ARMS

Jointed and reversible arms.

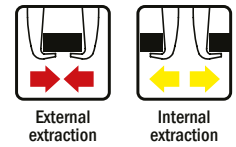

	Power Tons	mm	mm	mm	kg	£
796303	0.5 T	60	85	14	0.55	£35.60 <sup>B</sup>
796304	1 T	95	110	17	1.06	£46.28 <sup>B</sup>
796306	4 T	160	160	19	2.25	£76.54 <sup>B</sup>
796308	7 T	235	210	23	4.50	£137.95 <sup>B</sup>
796312	10 T	330	310	32	11.0	£380.92 <sup>B</sup>



## 796313ALT

### PULLER WITH 3 ARTICULATED ARMS

Extra-long version.

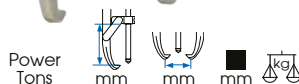
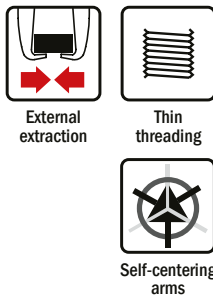

	Power Tons	mm	mm	mm	mm	kg	£
79631301ALT	1 T	105	110	12	1.0	£146.85 <sup>B</sup>	
79631304ALT	4 T	185	175	16	2.5	£186.01 <sup>B</sup>	
79631307ALT	7 T	225	240	19	6.5	£282.13 <sup>B</sup>	
79631310ALT	10 T	385	360	22	14.5	£577.61 <sup>B</sup>	
High capacity	79631317ALT	17 T	480	480	27	31.5	£980.78 <sup>B</sup>
	79631330ALT	30 T	585	580	37	55.5	£1,639.38 <sup>B</sup>



Convertible in 2 or 3 arms applications mode

High capacity

## 796373ALT

### PULLER WITH 3 JOINTED AND AUTO-CENTERING ARMS

Extra-long version.

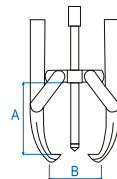
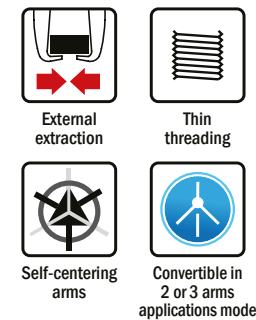

Thin and notched arms for a straight grip or fitting around a screw.

	Power Tons	A mm	B mm	mm	kg	£
79637304ALT	4 T	210	220	16	2.5	£203.81 <sup>B</sup>



Lightweight

## 796227

### LIGHTWEIGHT PULLER WITH 2 SELF-CENTERING ARMS

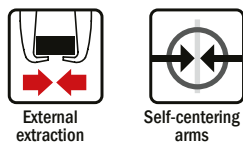
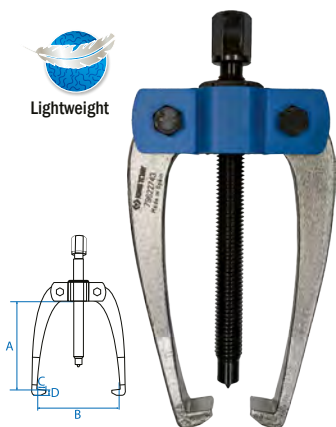

	Power Tons	A mm	B mm	C mm	D mm	kg	£
79622741	1 T	80	80	10.7	7.9	0.47	£55.18 <sup>B</sup>
79622743	3 T	122	116	11	8.1	0.87	£65.86 <sup>B</sup>
79622745	5 T	161	160	14.2	11.1	1.79	£92.56 <sup>B</sup>
79622748	8 T	202	200	19	14.5	3.26	£110.36 <sup>B</sup>



Lightweight

## 796327T

### LIGHTWEIGHT PULLER WITH 3 SELF-CENTERING ARMS

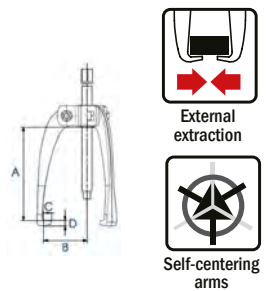

	Power Tons	A mm	B mm	C mm	D mm	kg	£
79632741T	1 T	80	80	10.7	7.9	0.59	£66.75 <sup>B</sup>
79632743T	3 T	122	116	11	8.1	1.09	£81.88 <sup>B</sup>
79632745T	5 T	161	160	14.2	11.1	2.28	£114.81 <sup>B</sup>
79632748T	8 T	202	200	19	14.5	4.18	£137.06 <sup>B</sup>

## 7963C

### 2 TO 3 REVERSIBLE ARMS PULLER

For internal and external extraction. The innovative arm structure makes jaw replacement quick and convenient, optimizing efficiency. Reversible arms provide great versatility, suitable for internal and external gears, axles, bearings, etc.



External extraction

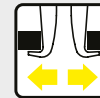

Internal extraction



Convertible in 2 or 3 arms applications mode



Convertible from 2 to 3 arms



Reversible arms



Quick adjustment of the operating range with the notched system

	Power Tons	A mm	B mm	mm	kg	
7963C03	2 T	50~76	45	13	0.45	£64.08 <sup>B</sup>
7963C05	5 T	101~127	75	17	1.50	£105.91 <sup>B</sup>
7963C08	8 T	127~200	172	17	2.89	£132.61 <sup>B</sup>

## 796218C

### MULTIFUNCTION 2 ARMS PULLER SET

For an internal, an external and screw extraction, for confined spaces. 4 additional arms. Tip protection.

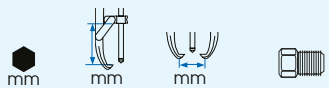

	mm	mm	mm		Power Tons	kg	
79621805C	17	173	140	9/16"x12h	5 T	2.7	£189.57 <sup>B</sup>
79621810C	22	250	182	3/4"x12h	10 T	6.0	£266.11 <sup>B</sup>



External extraction

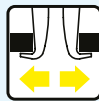

Internal extraction



Thin threading

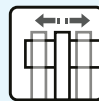

Sliding jaws

### 3 in 1



75-105 mm  
Separators and Beam



Puller with 2 arms



Puller with 3 arms

**New**



79621805J4 5T £364.01<sup>B</sup>

6.5

79621810J3 10T £566.93<sup>B</sup>

9.5

### 2 OR 3 ARMS MULTI-CLAW PULLER

For internal, external extraction, by screwing, in narrow spaces. Adjustable sliding arms. Thin threading.

422 x 372 x 92mm

#### Contents

- 12 claws
- 1 body for 2-claw mounting
- 1 body for 3-claw mounting
- 1 screw
- 1 screw tip protector.

9BA01 1/2" £337.31<sup>B</sup>

### HYDRAULIC PULLER SET

Includes forged steel bearing separator and gear puller. Operate up to 10 ton hydraulic pulling power. Special separator design of the strong back puller allows the puller to be used even in the tightest spaces.

#### Contents

17

- 1 PC. Beam
- 1 Set Separator Capacity 75~105mm
- 2 PC. Main Rod Hex bar (255mm)
- 2 PC. Extension Rod Hex bar (255mm)
- 1 PC. 10T Hydraulic Ram
- 1 PC. Ram Part
- 1 PC. Centre Adapter
- 1 PC. 3 arms body
- 1 PC. 2 arms body
- 3 PC. 102 mm (4") Leg
- 3 PC. 152 mm (6") Leg
- 3 PC. 203 mm (8") Leg
- 1 PC. 25 x 51 mm (1"x2") Extension Rod
- 1 PC. 25 x 102 mm (1"x4") Extension Rod



796226

**CROSS-JAW PULLERS FOR SPROCKET**

Wide-Claw version. Articulated claws. One-piece claw design.

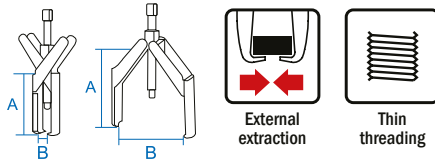

	Power Tons	A mm	B max mm	B min mm	Characteristics of the screw	kg
79622641	1 T	90	95	55	12 M10x1	0.3 £81.88 <sup>B</sup>
79622642	4 T	125	125	70	16 M14x1,50	0.8 £101.46 <sup>B</sup>
79622643	7 T	160	125	80	19 M14x1,50	1.0 £129.05 <sup>B</sup>

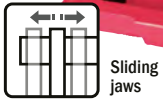

9BE5077C

£162.87<sup>B</sup>

**2-ARMS PULLERS FOR NON-DISENGAGEABLE ALTERNATOR PULLEY**

Several central screws included for perfect pulling. Long adapter included. Sliding arms. Specially designed for alternator pulleys.

mm	mm	mm	kg
63-100	11-50	14	1.3

9BE5077C



17 PC.

9BQ01

£143.29<sup>B</sup>

**SLIDE HAMMER PULLER SET**

Three types to use: internal/external puller, plate puller, dent puller. Use for removal of vehicle Hub, rear axle, bearing or repair dent, etc...

Contents	kg
<ul style="list-style-type: none"> <li>1 PC. 500 mm T handle shaft</li> <li>1 PC. 5 lbs / 2.2 kgs hammer</li> <li>1 PC. Axle puller</li> <li>1 PC. Hub puller</li> <li>1 PC. Hook</li> <li>1 PC. Locking pliers puller</li> <li>1 PC. Dent puller</li> <li>1 PC. Central bolt</li> <li>1 PC. Twin head</li> <li>1 PC. Tripe head</li> <li>1 PC. Adjustable nut</li> <li>3 PC. 3.5" leg</li> <li>3 set nut &amp; bolt</li> </ul>	7.5



796502

£63.19<sup>B</sup>

**MICRO BEARING PULLER**

Suitable for alternators, generators domestic appliances, power tools & pumps. Adjust arms by turning the screw.

Power Tons	A mm	B mm	kg
2 T	19 - 45	73	905

796502

2 T

19 - 45

73

905



6 PC.

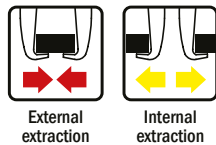

796401MR

£164.65<sup>B</sup>

**SLIDE HAMMER GEAR PULLER SET**

For jobs involving pull and grip gears, bearings, outer races, grease retainers, oil seals, etc. 2.6 lbs (1.2 kgs) slide hammer 400 mm length T-handle puller 3-in-1 hammer puller, to handle inside pull such as bearing cups and outer races, as well as regular outside pull jobs

Contents	kg
<ul style="list-style-type: none"> <li>1PC. 400 mm T handle shaft</li> <li>1PC. 2.6 lbs / 1.2 kgs hammer</li> <li>1PC. Adjustable nut</li> <li>1SET Internal gear puller for Ø15-30mm(A)</li> <li>1SET Internal gear puller for Ø30-80mm(B)</li> <li>1SET External gear puller for Ø15-80mm(C)</li> </ul>	4.5



14 PC.

9BE5158

£694.20<sup>B</sup>

**INJECTOR PULLER SET**

To quickly remove seized up injectors. Designed to remove injectors without damaging them. Adjustable arm-height to compensate for support irregularities. For BOSCH, DELPHI and SIEMENS double attachment injectors.

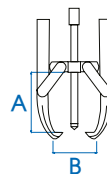

7969300K

£180.67<sup>B</sup>

**MINI EXTRACTOR SET**

Contents	kg
79629300 (B: 70, A: 55),	
79629301 (B: 100, A: 85)	
79639300T (B: 70, A: 55),	
79639301T (B: 100, A: 85)	

Related product



9BA120



9BA11  
+ 9BA120



Thin  
threading



Thin  
threading

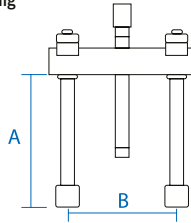

Related product



9BA220



9BA11S  
+ 9BA220

## 9BA11

### 2 ARMS BEAM FOR SEPARATOR

For an ideal pulley-extraction. Sliding and extendable arms. Fast and precise tightening. Extract by screwing bridge arms.

	B (max) mm	A mm	Power T	For separator NO.	Thread	kg	£
9BA1110	195	190	14	9BA1204B, 9BA1206B	3/4"x16h	3.4	£212.71 <sup>B</sup>
9BA1120	325	255	17	9BA1204B, 9BA1206B	1"x14h	9.5	£417.41 <sup>B</sup>

## 9BA11S

### 2 ARMS BEAM FOR REFINED SEPARATOR

Unscrew to pull. Precise and fast tightening. Sliding arms. For ideal stripper extraction of gearboxes and narrow spaces.

£168.21<sup>B</sup>

	B mm	A mm	Power T	kg	£
9BA1110S	62 ~ 195	175	10	3.0	

Related product



9BA11



9BA11  
+ 9BA120

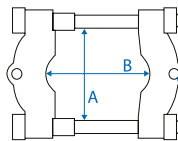

Related product



9BA11S



9BA11S  
+ 9BA220

## 9BA120

### SEPARATOR FOR BEAM OF 9BA1100 SERIES

For an ideal pulley-extraction.

£300.82<sup>B</sup>

	B mm	A mm	Ø D mm	For beam NO.	kg	£
9BA1206B	12 ~ 134	152	5/8"	9BA1110, 9BA1120	5.7	

## 9BA220

### SEPARATOR FOR BEAM OF 9BA1100S SERIES

Especially made for gearboxes and narrow spaces.

£158.42<sup>B</sup>

	B mm	A mm	Ø D mm	For beam NO.	kg	£
9BA2204B	10 ~ 110	110	5/8"	9BA1110S	2.75	



18  
PC.

2 in 1



80 x 80 mm



120 x 110 mm



External  
extraction

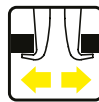

Internal  
extraction

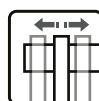

Sliding  
jaws

## 9BA9082

£324.85<sup>B</sup>

### SCREW PULLER SET

For internal, external and screw pulling. Spread 120 mm. Reach 110 mm.

Contents	kg	£
	2.8	
9BA1100		9BA1102
9BA1200		9BA1202A



12  
PC.

kg 5.25

## 9BA21

### SET OF BEARING SEPARATORS AND BRIDGES

CONTENTS:

- 1 bracket
- 1 separator 30~50 mm
- 2 main rods (102 mm)
- 2 extension rod (102 mm)
- 1 separator 50~75 mm
- 2 main rods (127 mm)
- 2 extension rod (127 mm)
- 1 beam central bolt 175 mm



30-50 mm



50-75 mm

£119.26<sup>B</sup>



Internal extraction

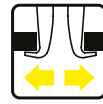
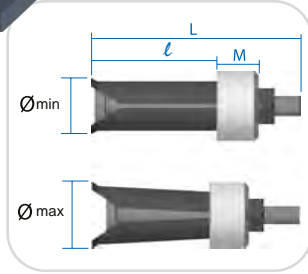

Internal extraction

Related product



9BE43

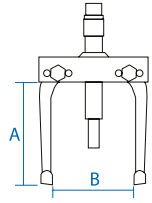

## 9BE43

### INTERNAL PULLING

Slide hammer 9BA4390 and puller 9BA4392.

	Ø mm	M mm	l mm	L mm	Clamp only	kg	£
9BE4347	47 ~ 54	39	88	175	9BE434705	1.32	£149.52 <sup>B</sup>
9BE4355	55 ~ 64	39	89	175	9BE435505	1.58	£177.11 <sup>B</sup>
9BE4365	65 ~ 76	39	89	175	9BE436505	1.95	£215.38 <sup>B</sup>

## 9BA4392

£142.40<sup>B</sup>

### BEAM FOR 9BE43 SERIES

	B mm	A mm	mm	Thread	kg
9BA4392	38 ~ 91	120	22	1/2" UNF 20h	1.5



Related product



79634704

kg 7.2

## 9BA4396

£260.77<sup>B</sup>

### SLIDE HAMMER FOR 79634704

375mm extension included.  
5000gr mass, 58mm diameter.  
Total length: 880mm, incl 750mm of hammering.



Self-centering arms



External extraction

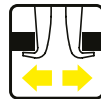

Internal extraction

Thread 5/8" 18h



2 PC.

kg 9.3

## P9BA4396

£648.81<sup>B</sup>

### SLIDE HAMMER AND PULLER WITH ARMS

Inertia extraction.  
For internal and external pulling.  
79634704 - Width internal pulling : 95~150 mm.  
79634704 - Width external pulling : 45~97 mm.

Contents

	79634704	
	9BA4396	5/8" 18h



Self-centering arms



Convertible in 2 or 3 arms applications mode



External extraction



Internal extraction



Internal extraction

## 9BA4311

£559.81<sup>B</sup>

### COLLET EXTRACTOR SET

For internal pulling.

Contents		kg
	9BE4300	Ø : 5~37 mm
	9BA4392	B : 38~91 mm

kg 3.5

## 9BA4322

£737.81<sup>B</sup>

### COLLET EXTRACTOR SET

For an external extraction.

Contents		kg
	9BE4300	Ø : 5~46 mm
	9BA4392	B : 38~91 mm
	9BA4390	1/2" UNF 20h

kg 5.2



Internal extraction



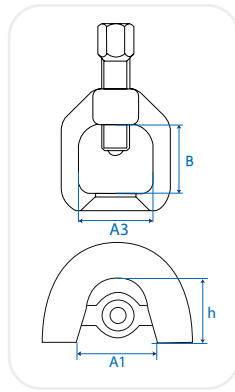

### 9BE5650

#### TRUCK BALL-JOINT SEPARATOR

For extracting steering joints.

	Max. Torque Nm	B mm	A1 mm	A3 mm	h mm	Screw mm	mm	kg	£
9BE5655	320	80	55.6	79	51	M1/2"x14x111	22	2.1	£144.18 <sup>B</sup>
9BE5656	400	100	59	102	50	M1/2"x14x112	22	2.3	£157.53 <sup>B</sup>

### 9BE45

#### DIRECT ACTION BALL JOINT EXTRACTOR

For removing steering tie-rods, stabiliser links, steering ball joints and other various ball joints.

	Max. Torque Nm	A mm	B mm	C mm	mm	1	kg
9BE45	400	77	100	46	24	1/2' 14h	2.3

£88.11<sup>B</sup>



### 7960991



### 7960991B



### 7960991C

### 796099

#### TAPER KEY EXTRACTOR

Taper key extractor with grip head. Made from robust materials. This extractor is designed to resist to intensive use and demanding agricultural work conditions. Guaranteed durability and consistent performance. Curved model facilitates access in difficult to reach areas or poorly positioned, minimizing risks of damaging fragile components or injury during operation. Handle width: 89.5mm

	l mm	L mm	kg	£
7960991	385	10	780	£40.94 <sup>B</sup>
7960991B	385	10	780	£40.94 <sup>B</sup>
7960991C	304	10	600	£30.26 <sup>B</sup>

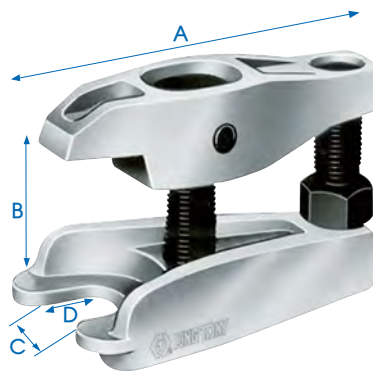

### 9BE5681

£74.76<sup>B</sup>

#### BALL JOINT EXTRACTOR ON SHAFT

For removing steering and suspension ball-joints. Universal.

	C mm	A mm	B mm	mm	D mm	kg
9BE5681	18 ~ 22	97	50	19	25	700



1.046

### 9BE1950

£169.99<sup>B</sup>

#### SLIDE HAMMER AND PULLER SET FOR FEMALE THREAD PIN SET (M4 - M10)

2 axes for the slide hammer and 4 adaptors M4, M5, M6 and M8. M10 thread directly remove itself without any adaptors. Designed for pulling female thread pin.



2

### 9BE1960

£283.91<sup>B</sup>

#### SLIDE HAMMER AND PULLER SET FOR FEMALE THREAD PIN SET (M6 - M20)

1kg slide hammer and puller set for female thread pin. Including 10 adaptors from M6 to M20. Designed for pulling female thread pin. 1 slide hammer 9BA4390 : 1/2" UNF 20h thread. 2 adaptors: 3/8" + 5/8". 8 adaptors: M6, M8, M10, M12, M14, M16, M18, M20.



25  
PC.

79

### 11225SQE

£97.01<sup>B</sup>

#### STUD EXTRACTOR SET

For external extraction.  
Right threaded drill bits.

##### CONTENTS:

- 10 external guides from M5 to M14
- 5 Right threaded drill bits: 4, 5, 6, 7.5, 8.5 mm
- 5 extraction pins
- 5 hexagonal adapters for pins

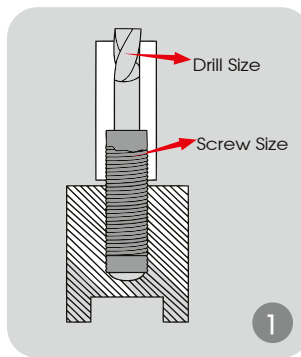

1

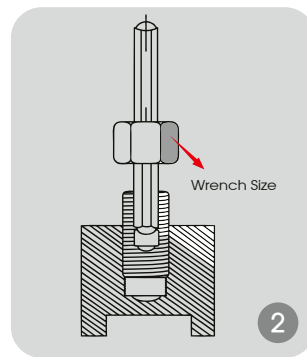

2



15  
PC.

0.53

### 11015SQ

£55.18<sup>B</sup>

#### SCREW EXTRACTOR SET

For removing damaged, broken, or jammed screws.  
For removing rounded, damaged, broken, or jammed bolts.

SNCM + V steel. Hardness : HRC 49-52.

##### Contents

- 12 mm 1/8", 3/16", 1/4", 3/8", 3/4, 5/5, 6, 8, 10 mm
- 16 mm 1/2", 11, 12, 14 mm



Do not ever use these hand extractors with a power tool, to avoid risks of damage or injury.

##### Operation :

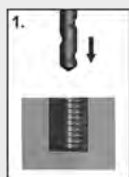

1. Drill a hole, 0.5 mm bigger than the extractor, on the bolt.



2. Insert the extractor inside the bolt.

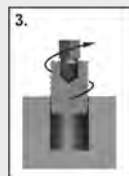

3. Turn counter-clockwise to remove the bolt.



5  
PC.

### 11205SQ

£11.57<sup>B</sup>

#### SCREW EXTRACTOR SET

For internal stud extraction.

##### Contents

103

- 9BE2127 M3~M6, M6~M8, M8~M11, M11~M14, M14~M18

##### Use with:

3912M

3911ML

3740ML



6  
PC.

82

### 11406SQ

£14.69<sup>B</sup>

#### DOUBLE ENDED SCREW EXTRACTOR SET

For removing damaged, broken, rusty, jammed screws.  
To be used with a powered drill. Drill a hole on a damaged screw, then extract it using the other end of the extractor.  
Contains 6 extractors from 2 to 12 mm to meet the most common situations.  
Manufactured from high hardness HSS for easier and faster drilling.

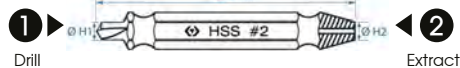

Drill	Contents	Ø H1	Ø H2	Extract
1	HSS #0	#0	2.5	2-3 mm
	HSS #1	#1	3.0	3-5 mm
	HSS #2	#2	3.5	4-8 mm
	HSS #3	#3	4.0	5-10 mm
	HSS #4	#4	6.0	6-12 mm



8  
PC.

### 11208SQ

£46.28<sup>B</sup>

#### SCREW EXTRACTOR SET

For internal stud extraction.

##### Contents

829

- 9BE2127 M3~M6, M6~M8, M8~M11, M11~M14, M14~M18, M18~M24, M24~M33, M33~M50



Good vision of the extraction process step by step.



34 PC.

12.9

9BE5198

£711.11<sup>B</sup>

**SILENT BLOCK PULLER SET**

Designed to assemble and disassemble the silent block, bearings and ball joints. No need for a hydraulic press.

**CONTENTS:**

- 340 mm threads (M10, M12, M14, M16)
- Ring: Ø int 34 to 72 mm, Ø ext 44 to 82 mm
- Top: Ø 34 to 72 mm



22 PC.

2.45

9DA022

£99.68<sup>B</sup>

**ALTERNATOR FREEWHEEL PULLEY REMOVER SET**

Used to install and remove freewheel alternator pulley  
 Conceived for the following alternators brands :  
 Bosch, Valeo, Magneti Marelli, Denso  
 Also works for VW, Audi, Citroen/Peugeot, Mercedes, Renault, BMW, Fiat, Ford, Toyota



4 PC.

1.89

9TD064

£70.31<sup>B</sup>

**NUT SPLITTER SET**

For removing stubborn nuts or over tightened bolts without damaging the bolt thread. Suitable for nuts to a tensile class 6.

**Contents**



- 9TD601 (9~12 mm)
- 9TD602 (12~16 mm)
- 9TD603 (16~22 mm)
- 9TD604 (22~27 mm)



Designed for used nuts or nuts rounded by time. Sockets made of SNCM (Silicon Nickel Chrome Molybdenum).

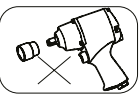

**!** Do not use these sockets with an impact wrench.



3 PC.

9TD033MR 1/2"

£44.50<sup>B</sup>

**1/2" HELICAL SOCKET SET ON RAIL**

**Contents**

400



- 9TD403 17, 19, 21 mm



4 PC.

9TD164MR 1/2"

£86.33<sup>B</sup>

**1/2" LONG HELICAL SOCKETS SET**

Sockets length: 146 mm.  
 Damaged Bolt Puller Bar 12x160mm.  
 After extraction, in case the damaged bolt gets stuck in the socket, use the 7641206P extraction bar to push it out.

**Contents**

1.36



- 9TD406 17, 19, 21 mm



- 7641206P



6 PC.

9TD036MR 1/2"

£86.33<sup>B</sup>

**1/2" HELICAL SOCKET SET ON RAIL**

**Contents**

400



- 9TD403 10, 12, 13, 14, 17, 19



# AUTOMOTIVE TOOLS

## FUEL



312

**9AB11**

£29.37<sup>B</sup>

### FUEL LINE PLIERS

For fitting and removing fuel line fittings.  
For VW-Audi, Fiat, GM, Opel/Vauxhall, Mercedes-Benz.

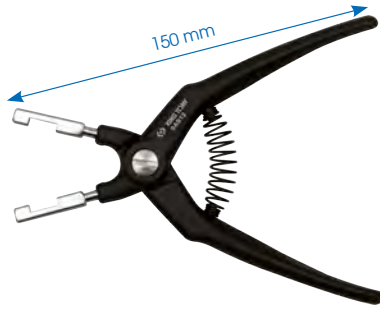

87

**9AB12**

£23.14<sup>B</sup>

### FUEL LINE PLIERS

For fitting and removing fuel line fittings.  
For VW, PSA, Fiat, Opel/Vauxhall.

## ACCESSORIES



203

**9TQ02**

£28.48<sup>B</sup>

### 3 IN 1 LED FLEXIBLE MAGNETIC PICK UP TOOL



To pick up hard to reach nuts and bolts.

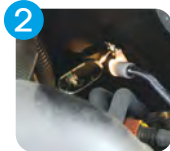

Inspection mirror: 50 x 25 mm. To inspect hidden or narrow areas. Pivoting mirror with double ball joint.

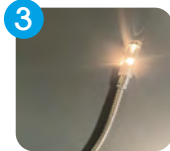

Light head

2x AA not included

**New**

1.6 kg

L2 : 685 mm

Ø16 mm

L1 : 574 mm



Flexible bending.

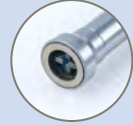

High power magnet supporting 1.6 kg.

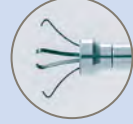

Maximum claw width 15 mm.

200

**2126B27**

£11.13<sup>B</sup>

### MAGNETIC CLAW PICK-UP TOOL

Compact, ergonomic finish for better handling.



**212924**

£34.71<sup>B</sup>

### LED MAGNETIC PICK-UP TOOL

3 in 1: magnet, hook and led lamp. Powerful magnet. Compact, ergonomic finish for better handling. Lithium battery: LR521x3.

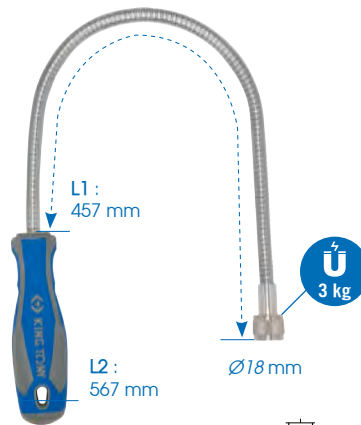
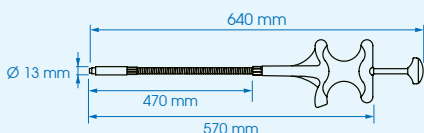

**2121A18**

£19.58<sup>B</sup>

### MAGNETIC PICK-UP TOOL

Flexible metallic shaft. Chemical and oil resistant.

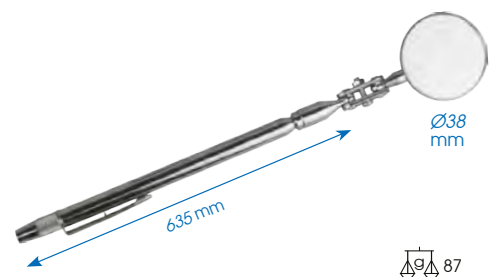
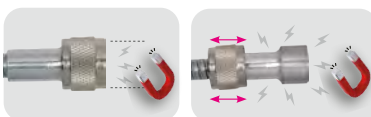

**9TQ21**

£9.26<sup>B</sup>

### 3-IN-1 TELESCOPIC MAGNETIC HANDLE



600 g magnetic power.

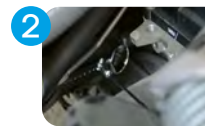

38 mm diameter inspection mirror for inspecting hidden or narrow areas. Rotating mirror for 360° vision.



Needle for cleaning wiper nozzle outlet.

\* The guarantee is unlimited in time, excluding bulbs, mirrors and LED lighting.

Offer valid from 01/01/2026 to 31/12/2026. Recommended retail prices in pounds excl. taxes. Non-contractual photographs.

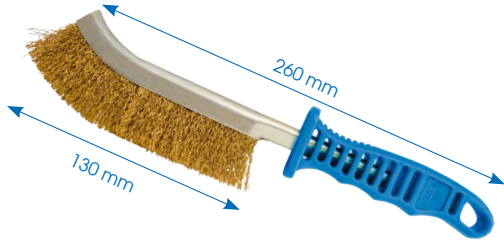

130

**9CZ201**

£3.56<sup>B</sup>

**CURVED WIRE BRUSH CORRUGATED STEEL WIRES**

For brushing jobs such as deburring, cleaning, derusting, smoothing, and flexibility requiring tasks.



**New**

278 x 178 x 44 mm

158 x 132 x 44 mm

134 x 80 x 44 mm

**9TE6403**

£27.59<sup>B</sup>

**SET OF MAGNETIC AND RETRACTABLE TRAYS**

- This set of three magnetic trays for small parts is ideal for all kinds of uses.
- Each tray is foldable, making it easy to store and transport.
- Their magnetic base helps to hold different parts in place while you work.
- Made from soft silicone, they grip well and protect surfaces from scratches.
- Recommended operating temperature: -20 to 70°C.



3 PC.

800



126

**9TG11**

£24.03<sup>B</sup>

**KNEE PROTECTOR**

Oil and chemical resistant. Reduces pain when kneeling. Anti-fatigue mat for knees.

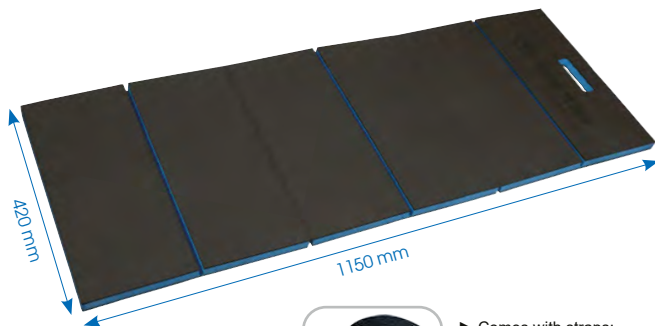

24 mm



► Comes with straps; may be stored folded and hung up for convenient storage.

991

**9TG22**

£54.29<sup>B</sup>

**FLOOR MAT WITH INBUILT LED LIGHTS**

Folding mat allowing mechanics to work while seating, kneeling or laying. Comes with straps; may be stored folded and hung up for convenient storage. Oil and chemical resistant.

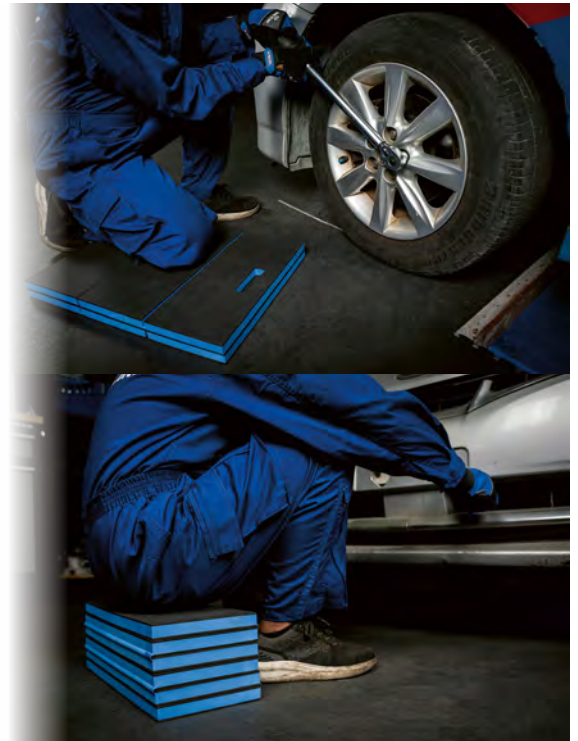

87H32AB

£59.63<sup>B</sup>

ADJUSTABLE WORK CHAIR

- Material : PVC leather + foam padding + PP plastic base.
- 4 removable plastic bases: 185 x 212 x 34 mm (1 magnetic).

Dimensions (mm)	kg
430 x 430 x 400	4.8



► 1 magnetic base



► Four 360° rotating wheels.



- Removable plastic frame to keep small tools and pieces easy to reach.



- Adjustable seat height from 400 to 540 mm, enabling to bend, kneel or squat.



- Soft touch seat, made of synthetic waterproof leather with a 50 mm thickness.



87C23AB

£52.51<sup>B</sup>

PLASTIC CREEPER

Practical, with a transport handle and two side storage trays to easily reach tools and small parts. Cushioned foam head support with vinyl cover for user comfort. 6 swivel wheels. 102 cm. Robust: plastic one-piece construction. Ground clearance: 6.35 mm.

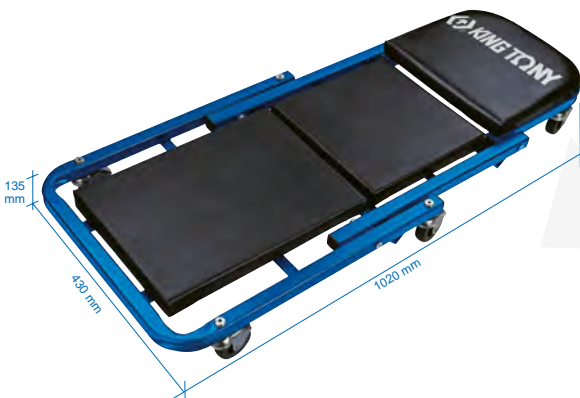

87C26AB

£70.31<sup>B</sup>

CONVERTIBLE STOOL INTO CREEPER TROLLEY

- Cushioned foam seat for user comfort.
- 6 rotating wheels for a full mobility.
- Large vinyl cushion for greater comfort while working.
- Robust and durable steel construction.

Dimensions (mm)	kg
1020 x 430 x 135	8.9



- Converts easily from stool into creeper trolley.



- 360° rotating wheels for easy movement.



- Cushioned foam seat, comfortable and soft to prevent fatigue.

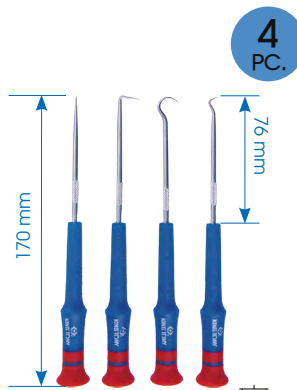

4 PC.

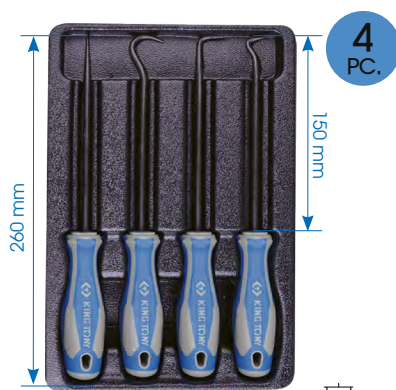

4 PC.

**30914AY** £12.28<sup>B</sup>

**HOOK SET**

To scribe, align, install and remove o-rings, gaskets, cotter pins and washers.

70

#7 (280 x 187 mm) £24.03<sup>B</sup>

**HOOK SET**

4 hooks: straight, angled, 90°, hooked. Bi material handle PP+TPR.

420

**New**

9 PC.

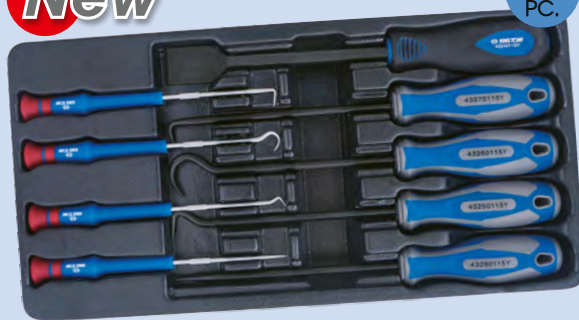

#8 (375 x 187 mm)

690

**930909AY** £41.83<sup>B</sup>

**HOOK SET**

Ideal for marking, aligning parts, installing or removing O-rings, gaskets, split pins and washers. Contains 4 precision hooks, 4 hooks and a wide scraper. 4 shapes : Bent Tip 45°, hook, bent Tip 90°, awl. Bi material handle PP+TPR.

**LUBRICATION**

**New**



One-hand use

1.16

**9BU1452TA** 400 cc £24.03<sup>B</sup>

**GREASE GUN WITH HANDLE**

Cartridge capacity: 400 cc. Air Pressure: 275 bars Flexible hose and metal fixed nozzle. Length: 365 mm.

**New**



1.2

**9BU2452TA** 400 cc £22.25<sup>B</sup>

**LEVER GREASE GUN**

Cartridge capacity 400 cc. Work pressure: 310 bars (max 700 bars). Fixed metal hose and flexible hose. Comfortable handle. Length: 360 mm.



770

**9BT250** 500 cc £27.59<sup>B</sup>

**OIL SUCTION GUN**

500 cc capacity. Flexible hose. Can drain or empty tanks in all fields. Length: 340 mm.



505.2

**9BU41** £37.38<sup>B</sup>

**PORTABLE BEARING PACKER**

Allows to packs bearings quickly and easily. Suitable for Bearing diameter up to 89 mm. Press the cap until the used grease is forced out and replaced by fresh grease.

**9TB**

**OILER**

Model	Capacity cc.	Weight g
9TB225	225	103
9TB500	500	302

9TB225 plastic 225 103 £9.79<sup>B</sup>  
9TB500 metallic 500 302 £12.46<sup>B</sup>



\* The guarantee is unlimited in time, excluding scrapers.

Non-contractual photographs. Offer valid from 01/01/2026 to 31/12/2026. Recommended retail prices in pounds excl. taxes.



**DRAIN - FILTRATION**

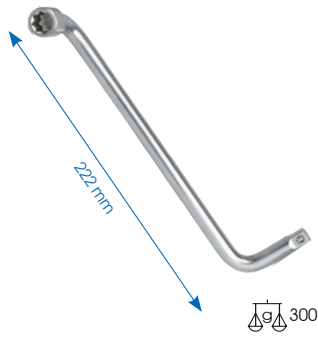

**159609** £7.30<sup>B</sup>

**DRAIN PLUG WRENCH**

Volkswagen 10 mm 8 point oil filter wrench. Width: 61 mm. Chromed finish.

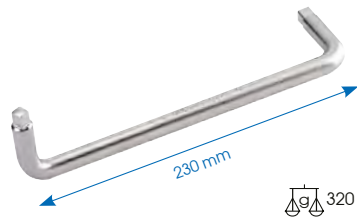

**158609** £5.25<sup>B</sup>

**DRAIN PLUG WRENCH**

Sizes: 8 and 10 mm. Chromed finish.



**32067A** Ø60~180 £30.71<sup>B</sup>

**OIL FILTER STRAP WRENCH**

- Capacity: 60-180 mm.
- Length: 279 mm.
- Strap length: 830mm.
- Suitable for oil filters and all hose types.
- Highly resistant nylon strap for better grip.
- Aluminum alloy handle.



**9AE31**

**OIL FILTER STRAP WRENCH**

Tilting PVC handle for narrow access

	Capacity (mm)	Weight (g)	Price (£)
9AE31111	95~111	307.8	£11.57 <sup>B</sup>
9AE31121	110~121	400.0	£12.46 <sup>B</sup>
9AE31134	120~134	400.0	£12.46 <sup>B</sup>
9AE3173	60~73	273.4	£10.68 <sup>B</sup>
9AE3185	73~85	283.0	£10.68 <sup>B</sup>
9AE3195	85~95	302.4	£11.57 <sup>B</sup>



**3203**

**STRAP WRENCH FOR OIL FILTER**

Ideal for use on oil filters, sanitary fittings, pipes, ect. Materials: wrench in carbon steel, strap in rubber and cotton yarn.

	Capacity (Ømm)	Length (mm)	Weight (g)	Price (£)
3203	60~140	223	242	£24.03 <sup>B</sup>
3203A	60~260	223	300	£29.37 <sup>B</sup>



**9AE43** Ø75~120 £23.14<sup>B</sup>

**SELF-TIGHTENING WRENCH**

3/8" square drive. Adapter 1/2"F to 3/8"M. Reinforced frame.



**LIMITED QUANTITY**

**9AR21** £8.72<sup>B</sup>

**OIL DRAIN PLUG FOR VAG**

Used to remove or install plastic oil drain plugs on the latest VAG vehicles.



**9AE52** Ø60~80 £64.08<sup>B</sup>

**9AE52110** Ø80~110 £100.57<sup>B</sup>

**SELF-TIGHTENING WRENCH**

1/2" Square drive. Electro-black oxide finish for rust protection.

\* The guarantee is unlimited in time, excluding straps.

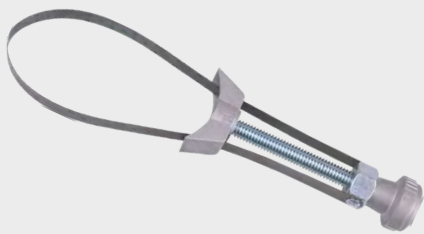

**9AE32110** £11.57<sup>B</sup>  
 Ø65~110  450

**9AE32155** £13.35<sup>B</sup>  
 Ø110~155  455

**METAL OIL FILTER STRAP WRENCH**











21 PC.

**9AR11** £58.74<sup>B</sup>

**DRAIN PLUG SOCKET SET**

Suitable for sump plugs on engine, gearbox and rear axle

- Contents  1.7
-  T45  M16  T10
  -  S5/16', S3/8", S7, S8, S10, S11, S12, S13, S14
  -  H8, H9, H10, H12, H13, H14, H17
  -  3/8"  10 mm



**3204** Ø60~140 £16.91<sup>B</sup>  359

**CHAIN OIL FILTER WRENCH**

Length: 225 mm.

**3209120** Ø60~120 £24.03<sup>B</sup>

**3209135** Ø60~135 £24.92<sup>B</sup>

**3209220** Ø60~220 £29.37<sup>B</sup>

**1/2" CHAIN SOCKET FOR OIL FILTER**

Suitable for removing all kinds of oil filter on vehicles. Chain designed to easily remove stubborn oil filters. Easy to use with a 1/2" ratchet.



**320560** Ø60~160 £52.51<sup>B</sup>  975

**DOUBLE CHAIN FILTER WRENCHES**

Flexible handle for narrow areas. Open the chain by simply pressing the head.



30 PC.

 6.5

**9AE6030** Ø65~120 £168.21<sup>B</sup>

**OIL FILTER CUP WRENCH SET**

Universal set.

- 1x extra flat self tightening wrench 9AE42 (65-120 mm)
- 1x 1/2"F to 3/8"M adaptor
- 28x 1/2" cup wrenches (65-108 mm)



**9TT1118** £15.66<sup>B</sup>  920

**OIL RECOVERY BIN**

The splash-proof edge prevents overflows. Not suitable for spray guns.

18L 

\* The guarantee is unlimited in time, excluding strap, chains and the recovery tray.

Non-contractual photographs. Offer valid from 01/01/2026 to 31/12/2026. Recommended retail prices in pounds excl. taxes.

## FRONT AXLE



LIFETIME GUARANTEE



### 9BE5

#### SELF-TIGHTENING TRACK ROD END REMOVER

Allows installation and removal of the axial direction hinges without removing the rack. Can fully separate the head from the rod to change the orientation of the direction's trajectory. Hex drive.

	Capacity (Ømm)	Length (mm)	Weight (kg)	Price (£)
9BE51	28~35	400	1635	£ 88.11 <sup>B</sup>
9BE52	35~45	400	2140	£ 105.91 <sup>B</sup>

### 9BE6

#### AXIAL DIRECTION BALL UNLOCKING TOOL

Allows installation and removal of the direction axial ball without having to remove the rack. Serrated inside for perfect grip. Can be used with 1/2" ratchets and extensions. Suitable for most light vehicles and trucks.

	Capacity (Ømm)	Length (mm)	Weight (kg)	Price (£)
9BE62	33~42	81.50	370	£ 57.85 <sup>B</sup>
9BE63	42~50	87.56	403	£ 64.08 <sup>B</sup>

## WHEELS



20 PC.

LIMITED QUANTITY

#### WHEEL LOCK SCREW SOCKET SET

This set allows professional mechanics to maintain wheels equipped with anti-theft nuts. Made of chrome-molybdenum (CrMo). Alloy steel chrome plated. Work 17mm hex tool.

### 9BW0120 VW £203.81<sup>B</sup>

Applicable for installing and removing locks of most VW models.

Contents 2.9

#521, #522, #523, #524, #525, #526, #527, #528, #529, #530, #531, #532, #533, #534, #535, #536, #537, #538, #539, #540
--

### 9BW0220 BMW £190.46<sup>B</sup>

Applicable for installing and removing locks of most BMW models.

Contents 1.94

#041, #042, #043, #044, #045, #046, #047, #048, #049, #050, #051, #052, #053, #054, #055, #056, #057, #058, #059, #060
--

New



Available in February



### 9BW0501

£132.61<sup>B</sup>

#### LOCKING WHEEL BOLT REMOVAL

- Versatile specialized tools to handle all types of anti-theft bolt.
- Effortlessly remove even the toughest anti-theft screws with the power of an impact driver
- Soft pads and protective covers safeguard both your rims and your hands, ensuring maximum safety with every use»

Contents

2.36

1 protective tray



6 keys for locking nuts

3 spare spring washers

1 impact screwdriver

1 impact body

impact socket 1/2"

1 needle



8  
PC.



**9BK7008** £50.73<sup>B</sup>

**STUD CLEANING BRUSHES TRAY**

For easily cleaning corrosion from studs ranging from 12 to 28 mm. Includes six brushes, a handle holder for brushes and 1/2" abrasive discs and a 1/2" screwdriver adapter. Quick and easy change of brushes on the 1/2" handle. Can be used with a screw gun or a 1/2" impact wrench.

Contents		545
	770 1/2" 770450	
	9BK711 1/2"	
	9BK72 12, 13, 14, 16, 22, 28	

8  
PC.



**9BK7009** £56.07<sup>B</sup>

**STUD AND HUB CLEANING ABRASIVE BRUSHES AND DISCS TRAY**

Quickly and easily cleans corrosion from 14mm and 22mm studs and hubs. Positioned on the hub studs and allows their surface to be cleaned over their entire length. Also cleans the rest of the hub between the studs. Includes two brushes, four abrasive discs, a brush holder handle and 1/2" abrasive discs and a 1/2" screwdriver adapter. Quick and easy change of brushes on the 1/2" handle. Can be used with a screw gun or a 1/2" impact wrench.

Contents		480
	770 1/2" 770450	
	9BK711 1/2"	
	9BK72 12, 22	
	9BK73 14x2, 22x2	

L

**9BK4153** £18.69<sup>B</sup>

**TYRE LEVER**  
Length L: 530 mm

**9BK4165** £28.48<sup>B</sup>

**TYRE LEVER**  
Length L: 650 mm

**New**



86 mm

250 mm

**9BK11** £17.80<sup>B</sup>

**WHEEL WEIGHT PLIERS**



LIFETIME GUARANTEE\*

11  
PC.

**9BK51E** £88.11<sup>B</sup>

**REPAIR KIT FOR TYRE-PRESSURE MONITORING SYSTEMS (TPMS)**

Complete kit for tightening valve nuts and Snap-in screws. Simplifies installing/changing the TPMS sensor and tyre valve. Complies with DIN ISO 6789 & ASME B107.14M2004 standards.

Contents		1.6
	2235M 1/4" 11, 12, 13	
	2033 1/4" T10, T15, T20	
	342113DG	341214M
	34101040M	275245G
	222104	

\* The guarantee is unlimited in time, excluding torque screwdrivers (covered by a 2-year warranty). Non-contractual photographs. Offer valid from 01/01/2026 to 31/12/2026. Recommended retail prices in pounds excl. taxes.

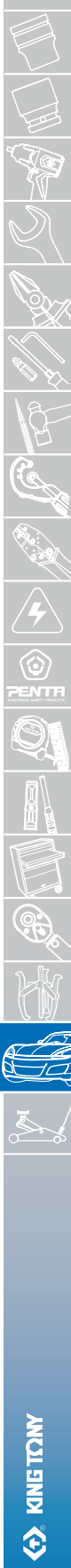

## CLUTCH

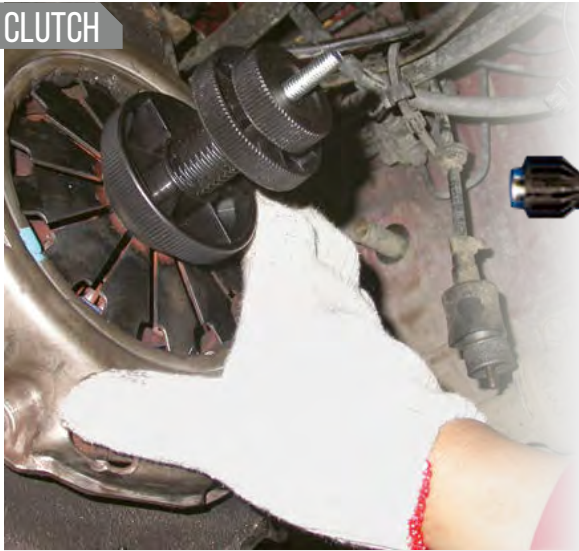

3  
PC.

9AK111

£16.02<sup>B</sup>

### UNIVERSAL CLUTCH ALIGNER

Designed to align and assemble the clutch. Delivered with 3 collets. Capacity: 15.5-27 mm.



190

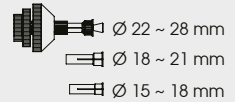

## SUSPENSION

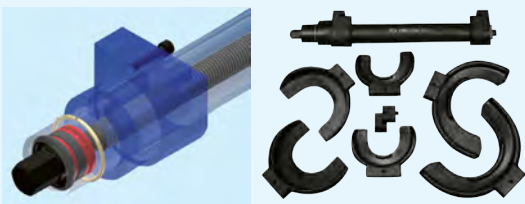

8  
PC.



Ø 110~150 mm    Ø 80~115 mm    Ø 140~195 mm

15

9BF31

£533.11<sup>B</sup>

### SPRING COMPRESSOR SET

Developed for the MacPherson spring coil, delivered with 3 sets of interchangeable 1-component cups. Max torque: 350 Nm. Compression power: 450 kg / 4410 Nm. Capacity: 40-300 mm. Length: 460 mm.

Suitable for: BMW, Ford, VW, Audi, Porsche, Saab, Vauxhall, Volvo, Nissan, Honda, Mitsubishi, Subaru, Toyota.

## LAMBDA SENSOR

LIFETIME GUARANTEE

7  
PC.



2.13



9AJ017 3/8"+1/2"

£83.66<sup>B</sup>

### LAMBDA SENSOR SOCKET SET

Special sockets for removing Lambda sensors, injectors and radiator thermal contacts. Suitable for most vehicles: Volkswagen, BMW, PSA, Mercedes-Benz, Ford, etc...

○	○	○	○
3/8"	27 mm	1/2"	29 mm
3/8"	22 mm	1/2"	27 mm
3/8"	22 mm	1/2"	22 mm

4  
PC.



190 x 60 x 48 mm



9AJ014

£83.66<sup>B</sup>

### EXTRA-SHORT LAMBDA SENSOR SOCKET SET

Temperature, NOX and particles sensor sockets. Extra-short socket to access difficult to reach areas.

#### Contents

9AJA0	30 mm	20, 22, 24 mm
4935M	1/2"	30 mm

0.96

## WINDSHIELD



9CW01

£54.29<sup>B</sup>

456

### WINDSHIELD REMOVAL TOOL KIT

Suitable for cutting windshield seals.

#### CONTENTS:

- A - Starting needle
- B - 2 piano wire handles
- C - Reel of piano wire - 22 meters



9CW22

£17.80<sup>B</sup>

351

### SUCTION CUPS FOR WINDSHIELD

Lifts up to 40 kg in horizontal position. 120 mm rubber suction cup for a firm hold on the surface carried to avoid damage. Suitable for handling glass, tiles, sheet metal.



## ENGINE



Camera Hose Length: 980 mm



331

9TQ12

£60.52<sup>B</sup>

### WiFi PORTABLE VIDEOSCOPE

Before use, download the Inskam APP, available for iOS & Android. 5.5mm lens with 6 LED, can be used for shooting video or taking photo (1080P HD Camera 1920 x 1080 resolution). Suitable for visually inspecting areas that are difficult to access over a great distance. Rechargeable battery: 1700 mAh Li-ion. Autonomy: 2-3 hours of continuous use.



1.43

9AT3A04

£79.21<sup>B</sup>

### CAMSHAFT SPROCKET PULLER

Use to hold and remove the camshaft sprocket without damaging. Use with 3/8" square drive tool or 19mm wrench. Suitable for most sprockets from Ø60 to Ø100 mm.



700

9AC23154

£33.82<sup>B</sup>

### CYLINDER HONE

For lapping and polishing engine cylinders from 50 mm to 175 mm. Easy to change honing stone. Easy spring tension adjustment. Medium grit 220 honing stone.

ENGINE

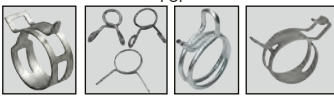

**99AA11** £18.51<sup>B</sup>

**STRAIGHT PLIERS FOR SELF-LOCKING COLLARS**  
The swivel jaws are designed to install and remove hose clamps. Compatible with Audi & VW

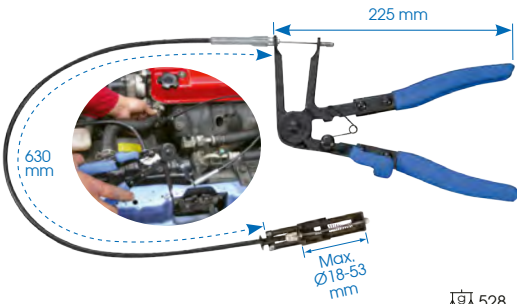

**99AA31** £61.41<sup>B</sup>

**FLEXIBLE PLIERS FOR SELF-TIGHTENING CLAMPS**  
630 mm flexible extension.  
For replacing hose clamps in hard to reach areas.

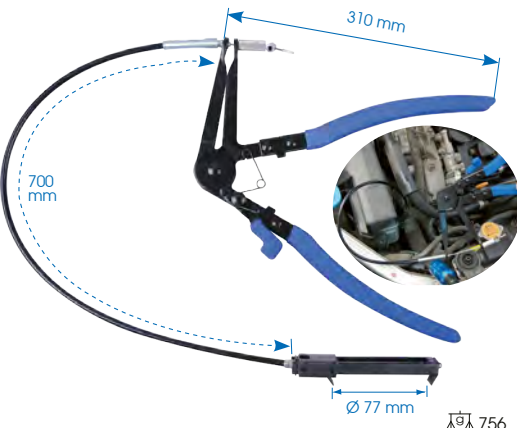

**99AA32** £84.55<sup>B</sup>

**FLEXIBLE HOSE CLAMP PLIERS**  
700mm long Flexible.  
Used to remove and install spring clamp.  
Flexible flat jaw with greater access in confined spaces.  
Suitable for universal cars, especially VW, Ford, Nissan.



11 PC.

**99AA01E** £265.22<sup>B</sup>

**HOSE CLAMP PLIERS SET EVAWAVE**

Contents		3.7	
	1453 05, 06, 07, 08, 10 mm		9AA13 9AA16
	9AA17		9AA21 9AA25 9AA31



**99BP21** £32.04<sup>B</sup>

**EXHAUST CLAMP PLIERS**  
For Citroën/Peugeot. Pliers can be locked in open position.



**99BP11** £20.47<sup>B</sup>

**SILENT EXHAUST BLOCK CLAMP**  
Pliers to remove the rubber mounts on exhaust lines For all vehicles.

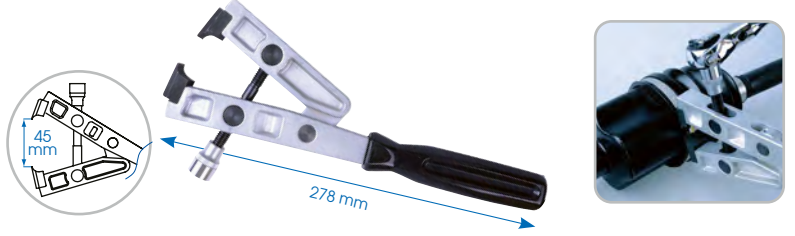

**99BB13** £67.64<sup>B</sup>

**BOOT CLAMP PLIERS**  
Boot clamp pliers for stainless steel drive shafts. Can be used with a 3/8" torque wrench.  
Suitable for Audi, VW, Ford and Vauxhall.



**99DB201** £15.13<sup>B</sup>

**SPARK PLUG BOOT PLIERS**  
Safely removes spark plug cables. Covered head to prevent cable damage. PP Handle.

\*The guarantee is unlimited in time, excluding hoses and spark-plug wire pliers.

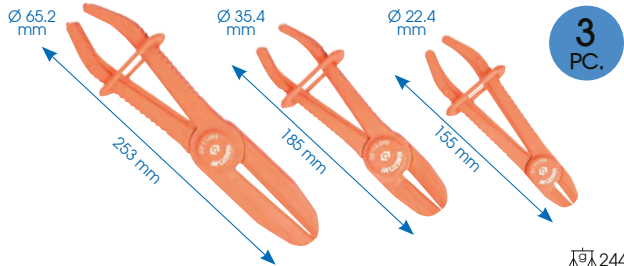

3 PC.

**9AF113**

**HOSE CLAMP PLIERS SET**  
Adjustable jaws to prevent damage to the hose. For 15 mm to 60 mm hoses. Useful for blocking radiator, heating, fuel, coolant and brake hoses.

£18.69<sup>B</sup>



3 PC.

**9AF123**

**HOSE CLAMP PLIERS SET**  
Adjustable jaws to prevent damage to the hose. For 17, 25 to 42 mm hoses. Useful for blocking radiator, heating, fuel, coolant and brake hoses. The angled jaws provide easy access to confined spaces.

£22.25<sup>B</sup>



Contents	
	9AF12
	17, 25, 42 mm



60

**9AL31**

**PSA BELT MOUNTING TOOL**  
Designed for installation of expandable belt on water pumps. Nylon fiber material prevents from damaging components during use. Compatible with PSA Group vehicles and Vauxhall/Opel 1.0 L and 1.2 L 3-cylinder engines manufactured since 2012.

£10.68<sup>B</sup>



Vehicle brand and type

	mm	Inch	mm
9AL31	18	2-3/4"	69

Citroën : Berlingo, C1, C3, C3 Picasso, C3 Aircross, C4, C4 Picasso, C4 Cactus, C-Elysee, DS3, DS4, DS4S and DS5LS.  
Peugeot : 108, 208, 301, 308, 408, 2008, 3008, 5008 Partner.  
Vauxhall/Opel : Crossland X.



**COOLANT**



Works without adaptor thanks to its rubber cone which adapts to fit perfectly all diameters from 17 to 40 mm.

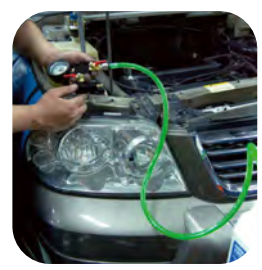

For quickly changing coolant vacuum.

**9AM012**

**UNIVERSAL COOLING SYSTEM PRESSURE TESTER**  
Makes checking for radiator leaks easy. Professional design, high-pressure resistant. Special hose hooks for quick replacement.

£310.61<sup>B</sup>



Universally suitable : MB, GM, Jeep, Peugeot, Subaru, Chrysler, Acura, Mitsubishi, Nissan, Mazda, Toyota, Infiniti, Suzuki, Isuzu, Honda, Acura, Lexus, Volvo, Saab, Citroën, Renault, Fiat, Alfa, Mini Cooper, BMW, Ford, Vauxhall, Porsche, etc....





**9DD21** £7.12<sup>B</sup>

**BATTERY TESTER**

Fast reading of the battery's acid concentration (in g/L). Used to determine the charge level of the battery. Tests 6, 12 and 24 V tensions.



**9AC**

**PISTON RING COMPRESSOR**

For easy insertion of piston into cylinder bore and even compression. Strip steel. Delivered with hex key (6mm)

	Capacity (mm)	Height H (mm)			
9AC12532	57-125	80	260	£ 14.24	<sup>B</sup>
9AC12540	57-125	100	280	£ 14.24	<sup>B</sup>
9AC17532	90-175	80	300	£ 14.24	<sup>B</sup>
9AC17540	90-175	100	320	£ 14.24	<sup>B</sup>
9AC17566	90-175	165	530	£ 28.48	<sup>B</sup>

**SPARK PLUGS**



135 x 78 x 33 mm 356



**9DM1A1** 3.5~24V £75.65<sup>B</sup>

**DIGITAL GLOW PLUG TESTER**

Suitable for steel and ceramic spark plugs (3.5, 4.4, 5, 7, 8.5, 10, 11, 24 V). LCD display. Short circuit and reverse charge protection. Automatic stop: 110 seconds.

**BRAKES**



6 PC.

**9BC5001MR** £104.13<sup>B</sup>



**BRAKE BLEEDER WRENCH SET**

Wrench dimensions: 7, 8, 9, 10, 11 mm. Ideal for bleeding the brake system and hydraulic clutch system without removing the wheels. Internal sealing made of high quality material to improve durability.

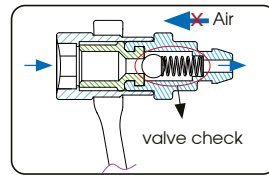

Integrated valve check, preventing the backflow of air into the braking system.



Can be used on any vehicle, SUV, van or motorcycle brake callipers.



Combined wrench and socket to facilitate loosening and tightening.



Silicone tube resistant to acidic and alkaline liquids, corrosion, wear and extremes temperature.

**GLOW PLUGS**



6 PC.



**3716MR** £78.32<sup>B</sup>



**3/8" ARTICULATED SOCKET SET**

For diesel engine Glow plugs. Sockets have a ball retainer to hold them in place.

**Contents**



	3785M	8, 9, 10, 12, 14, 16
--	-------	----------------------



5  
PC.

0.587

**9BC4A05MP** 1/2" £43.61<sup>B</sup>

**BRAKE CALIPER SOCKET SET**

Brake caliper sockets for Volkswagen, Audi and Porsche (VAG) vehicles.  
10-teeth sockets: Ø 11.5 mm, Ø 15 mm, Ø 20 mm.  
7-teeth socket: Ø 14 mm, Ø 22 mm.

LIFETIME GUARANTEE

Contents	Number of teeth	Ø (mm)	Vehicle brand and type
9BC42A11	10 teeth	11.5	Porsche
9BC42A15	10 teeth	15	Audi Q7, S8 e Porsche Macan, Cayenne, Cayman
9BC42A20	10 teeth	20	Audi A8, S6 e Porsche Cayenne
9BC41A14	7 teeth	14	Audi Q7, S4
9BC41A22	7 teeth	22	Audi S5



2  
YEAR  
GUARANTEE

1.05

**9TV14020** £150.41<sup>B</sup>

**PNEUMATIC BRAKE BLEEDER**

Air operated, handle trigger and noise-reduction design, easy to use. Allows to replace the old brake fluid without leakage. With 1m silicon hose and universal rubber adapter.

Capacity (L)	Air Pressure (PSI)	Air inlet (inch)	Temperature range (°C)
2	40~170	1/4"	-19°C~60°C

**9TV14020**

2  
YEAR  
GUARANTEE

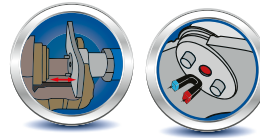

Increased space

Magnetic



1.35

**9BC251A01** £85.44<sup>B</sup>

**PNEUMATIC DISC BRAKE WIND-BACK TOOL**

Increased space. Slim version. Designed to facilitate brake disc change operations. The tool can be turned left and right - suitable for regular and reverse thread pistons.



LIFETIME GUARANTEE\*

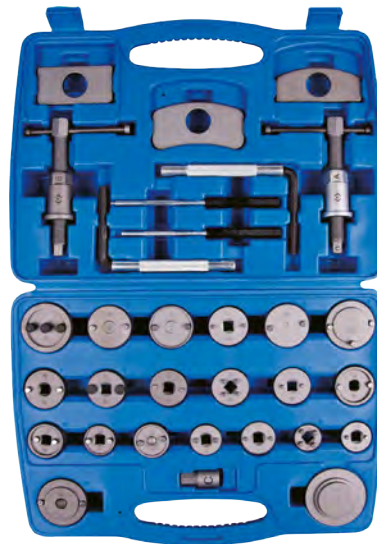

31  
PC.

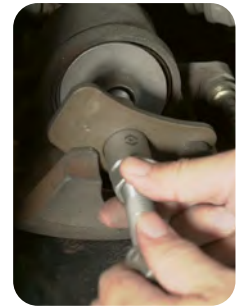

4.87

**9BC23** £194.91<sup>B</sup>

**DISC BRAKE REWIND TOOL SET**

For rotating pistons back into the caliper to provide clearance for new brake pads. Prevent damages to the pistons and caliper.

CONTENTS:

- 21x piston adaptors
- 3x reaction plates
- 1x 3/8" rotating square drive for caliper (left)
- 1x 3/8" rotating square drive for caliper (right)
- 2x hex keys: 7, 8 mm
- 2x punches: 5.5, 6 mm
- 1x 3/8" hex bit socket: 12 mm

Suitable for BMW, Ford, VW, Audi, Porsche, Saab, Opel, Volvo, Jaguar, Citroën, Peugeot, Renault, Vauxhall, Lancia, Alfa Romeo, Fiat, Nissan, Honda, Subaru, Toyota, Mitsubishi.

\* The guarantee is unlimited in time, excluding adaptors.

Non-contractual photographs. Offer valid from 01/01/2026 to 31/12/2026. Recommended retail prices in pounds excl. taxes.



## BODYWORK

**9CF120**

£27.59<sup>B</sup>

**9CF110**

£27.59<sup>B</sup>

**9CF210**

£24.03<sup>B</sup>

**9CF241**

£21.36<sup>B</sup>

**9CF132**

£24.03<sup>B</sup>

**9CF240**

£24.92<sup>B</sup>

**9CF220**

£24.03<sup>B</sup>

**9CF230**

£21.36<sup>B</sup>



7 PC.

430 x 350 x 95 mm

**9CF107**

£197.58<sup>B</sup>

### AUTO BODY REPAIR TOOL SET

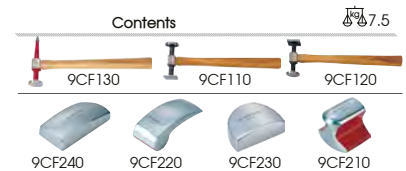

These products are not covered by commercial warranty.



3.5

**9CH212**

£177.11<sup>B</sup>

### PNEUMATIC DENT PULLER

- 1.36 kg sliding hammer.
- 2 pads (120mm, 150mm).
- Brass valve.
- 1/4" air plug.
- 325mm length inlet hose.
- Air exhaust from the handle.
- Working pressure: 6.3 bar.
- Weight: 3.5 kg.



### LIFETIME GUARANTEE

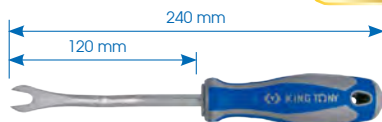

**43280212**

£4.63<sup>B</sup>

**DOOR TRIM HOOK**  
Removes door upholstery without causing damage.



9.5

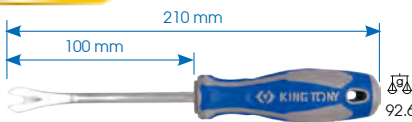

**48280180**

£8.37<sup>B</sup>

**DOOR TRIM HOOK**  
Removes door upholstery without causing damage.



5.7



6 PC.

**9CI016**

£26.70<sup>B</sup>

### TRIM REMOVAL SET - 6 PCS

Ideal for removing inside door handles, door trims, dashboard trims. Thin profile. For easily removing door trims.

328



1050 x 650 mm

520

**9TP22**

£35.60<sup>B</sup>

### WING PROTECTOR WITH 3 SUCTION PADS

Protects against scratches, dents and dirt. Robust, cushioned material with reinforced edges. The suction pads stick firmly to aluminium alloy surfaces. Magnetic strip for a better hold.

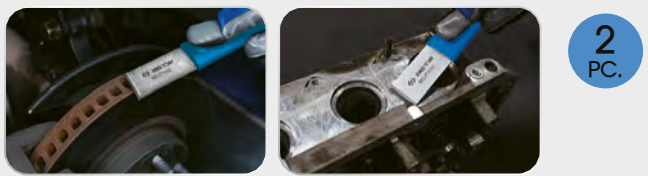

2  
PC.



9CJ072

£48.06<sup>B</sup>

**TUNGSTEN CARBIDE SCRAPER SET**

The blade tip is made of tungsten carbide material, which offers high hardness and a long lifespan. It can be used to scrape off residual carbon deposits, rust marks, or silicone residue from surfaces of objects, such as old silicone on oil sumps, exhaust manifolds, or brake callipers. The blade tip is equipped with a protective cover.

10  
PC.



SK5  
40 mm



Steel blade x4



Plastic blade x5

160

9CJ61C1

£14.24<sup>B</sup>

**MULTI-PURPOSE SCRAPER**

Designed for fast scraping of labels, seals, paint and glass or metal residues. 4 SK5 high-grade steel blades. 5 POM plastic blades. Fits all standard single-edge razor blades. Ergonomic PP+TPR handle.



3  
PC.

215 x 259 x 30 mm

9CJ013

£25.81<sup>B</sup>

**STAINLESS STEEL PUTTY KNIFE SET**

3 Flat engineers' scrapers width of 32 to 76 mm. Total length: 218 mm.



212



3  
PC.

175 x 259 x 30 mm

9CJ023

£29.37<sup>B</sup>

**STAINLESS STEEL BOLSTERED SCRAPER SET**

3 engineer's 32 to 50 mm-wide scrapers, including one bent scraper. Metal impact zone. Total length: 218 mm.



389



3  
PC.

175 x 259 x 30 mm

9CJ033

£20.47<sup>B</sup>

**STAINLESS STEEL PINCHWELD SCRAPER SET**

3 Engineers' scrapers special welders' type width of 12 to 19 mm. Total length: 168 / 218 mm.



258



149

43240115Y1

£6.68<sup>B</sup>

**JOINT SCRAPER**

Remove old seals more easily and quickly.

LIFETIME GUARANTEE



241

9TC101

£21.36<sup>B</sup>

**CLIP REMOVAL PLIERS**

For removing inner door-linings and other trim items held in place by plastic rivets. Finger protection.



580 x 350 x 170 mm

17

9TY120040A

4T

£239.41<sup>B</sup>

**4 TONS BODYWORK REPAIR KIT**

4 tons hydraulic jack with lever and hose. Hydraulic extension bars : 82, 125, 215, 418, 495 mm. Hydraulic spreading wedge. Push ram. Set of sheet metal reshaping tools.



820 x 435 x 170 mm

31

9TY12010AB

10T

£343.54<sup>B</sup>

**10 TONS BODYWORK REPAIR KIT**

10 tons hydraulic jack with lever and hose. Hydraulic extension bars : 127, 250, 456, 685 mm. Hydraulic spreading wedge. Push ram. Set of sheet metal reshaping tools.

**New**



215 mm

580

**10BOB**

1/4"

### BRAKE CALIPER SLOGGING WRENCH

- Use for the assembly and removal of the brake caliper on commercial vehicles
- «Designed with a 3/4" DR., can be used with torque wrenches for tightening operations
- The torque adjustment formula, laser engraved on the wrench, facilitates the calculation of the exact tightening torque during assembly.
- Wrench made of 44 HRC hardness steel, ensuring robustness and longevity.

		Application	L (mm)	
10BOBE18	E18	MAN TGL, TGM	215	£20.47 <sup>B</sup>
10BOBE20	E20	MAN TGL, TGM	215	£20.47 <sup>B</sup>
10BOBE24	E24	MAN TGA, TGS, TGX	220	£20.47 <sup>B</sup>



**2**  
YEAR  
GUARANTEE

146 mm  
185 mm

20 mm



**9BM2210A**

£76.54<sup>B</sup>

### 3 IN 1 TYRE INFLATOR

Diaphragm gauge. Accuracy: ANSI B401.1. Rubber casing to protect the gauge from bumps. 3 functions on the handle: pressure check, deflation, inflation. 400 mm flexible rubber hose for high pressure. Standard air chuck for cars. Long air chuck for hard to reach valves: suitable for trucks, buses and tractors. Pressure range: 0-15 Bars (0-220 PSI). Integrated hook for easy storage. Air inlet: 1/4". Air hose: 3/8".



3L

246 mm

316 mm

156 mm

390

**9TT2103**

£14.77<sup>B</sup>

### OIL RECOVERY BIN FOR TRUCK HUBS

**New**

LIFETIME GUARANTEE



**9HB885M**

### 12 POINT TRUCK AXLE NUT SOCKET



**9HB8B5M**

### 8 POINT TRUCK AXLE NUT SOCKET

Heavy-duty socket for truck wheel axle maintenance. Material - Steel S45C. Finishing - phosphate sunk

	ø mm	L (mm)	Suitable for truck axles		
9HB885M	85	58.5	IVECO	1512	£155.75 <sup>B</sup>
9HB8B5M	115	82	VOLVO	2835	£212.71 <sup>B</sup>

LIFETIME GUARANTEE



1.9

**9AE5001GM** Ø110~142

£244.75<sup>B</sup>

### MAGNETIC SELF-TIGHTENING WRENCH

Coated with electro-black oxide finish for protection against rust. 350 Nm resistance, fixed hexagon drive.

LIMITED QUANTITY



**2**  
YEAR  
GUARANTEE

342 x 168 x 94 mm

9.3

**3488A03MP**

£137.06<sup>B</sup>

### 47:1 TORQUE MULTIPLIER

Ideal for loosening wheel bolts on HGVs, buses, agricultural or civil engineering machinery. Manual torque multiplier. Compact, robust and designed for professional use. Delivered with two hex impact sockets 32-33 mm. Ratio: 47:1. Max applied torque 4700 Nm.



## 9BA12

### PLUG-IN TOOL FOR SHAFT SEALS

Designed to fit axle seals without damaging them. For trucks. Use with a rubber hammer.

	∅ (mm)	Compatible with	kg	£
9BA12165	165	Mercedes-Benz Actros FA	222	£105.91 <sup>B</sup>
9BA12175	175	Mercedes Actros AP rear axles	191	£123.71 <sup>B</sup>
9BA12187	187	Mercedes-Benz Actros FA	253	£137.06 <sup>B</sup>
9BA12208	208	Mercedes-Benz, MAN, DAF	378	£194.91 <sup>B</sup>

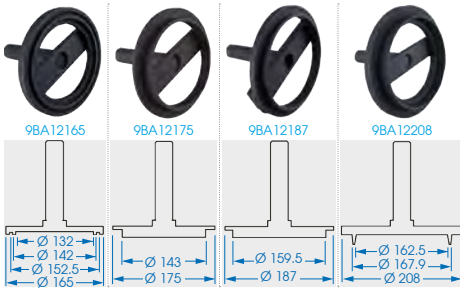

728 mm

kg 1470

9BK4173

£85.44<sup>B</sup>

TYRE LEVER - HVG VERSION

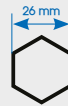

9HBE4

### REINFORCED HGV DIRECT ACTION BALL JOINT SEPARATOR

Can be used with an impact wrench. Suitable for all types of truck or vehicle. For removing steering tie-rods, stabiliser links, steering ball joints and other various ball joints.

	A mm	B mm	kg	£
9HBE439	39	95	2.32	£159.31 <sup>B</sup>
9HBE458	58	120	4.20	£372.91 <sup>B</sup>
9HBE462	62	120	4.20	£372.91 <sup>B</sup>

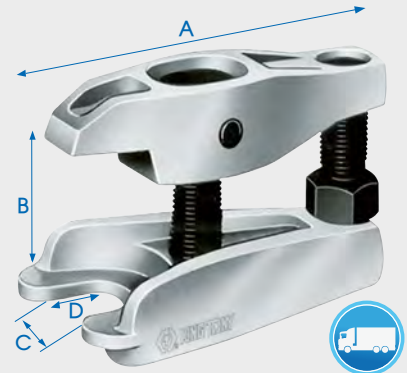

9BE5683 28~32 £152.19<sup>B</sup>

9BE5685 32~36 £249.20<sup>B</sup>

### BALL JOINT EXTRACTOR ON SHAFT

For removing steering and suspension ball-joints. Universal.

	C mm	A mm	B mm	∅ mm	D mm	kg	£
9BE5683	28 ~ 32	155	95	30	30	2600	
9BE5685	32 ~ 36	191	120	26	50	5200	



3 PC.

9HBE81

£319.51<sup>B</sup>

### REINFORCED HYDRAULIC HGV BALL JOINT SEPARATOR

Reinforced hydraulic HGV ball joint separator. For separating steering and suspension ball joints. Reinforced opening and lever. Delivered with a manual and a hydraulic 12T screw. Ideal for HGVs, buses, agricultural or civil engineering machinery.



kg 7.0

CYLINDERS

2 YEAR GUARANTEE

Arm opening : 70 mm  
Arm width : 36 mm

9HBE083

£304.38<sup>B</sup>

### HYDRAULIC HGV BALL JOINT SEPARATOR

Hydraulic HGV ball joint separator. Interchangeable arms 30 mm, 34 mm, 40 mm. Delivered with a manual and a hydraulic 12T screw. Ideal for HGVs, nozzles, agricultural or civil engineering machinery.

5 PC.

kg 8.55



Arm width : 30, 34, 40 mm

## PNEUMATIC DRAINER AND OIL COLLECTOR



**9TVP180AB**

£509.08<sup>D</sup>

### AIR SUCTION - OIL DRAINER

2 drain modes :

- 1) Direct suction: Fast action, via the gauge well. Ensure the oil tank is under negative pressure. No need to lift the vehicle and to remove the oil extractor.

Plexiglass analysis tank transparent with graduation, designed to easily visualize the condition of the extracted oil and the volume (9 L).

- 2) By gravity (under deck elevator or pit) : Convenient, thanks to the large collecting funnel oil and adjustable in height.

■ Air Pressure (bar) : 6 - 8

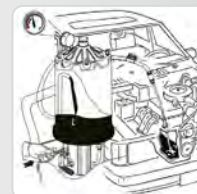

	Oil tank capacity (liters)	Minimum height (mm)	Maximum height (mm)	kg
--	----------------------------	---------------------	---------------------	----

<b>9TVP180AB</b>	80 L	1/4"	40-60°C	26.1
------------------	------	------	---------	------

## UNIVERSAL LEVER

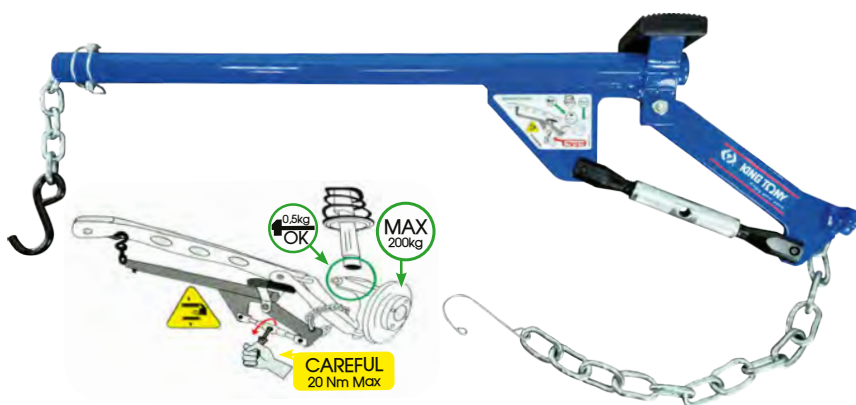

**9BH1000**

£186.01<sup>D</sup>

### FRONT AXLE LEVER BAR

Avoids dismantling the spindle or the wishbone.  
Manual assembly, simple, fast and safe.  
Suitable for all cars and light commercial vehicles.

	Capacity (kg)	Minimum height (mm)	Length (mm)	Width (mm)	kg
--	---------------	---------------------	-------------	------------	----

<b>9BH1000</b>	200	300	1000	130	6
----------------	-----	-----	------	-----	---

## ENGINE STAND



■ Allows balancing the weight to ease handling and positioning of the engine.

**9TY621AB**

£40.94<sup>B</sup>

### ENGINE LEVELER

Balance adjustment by hand crank. Comes with 4 support chains.  
Compatible with workshop cranes 9HYGR11 / 9HYGR55 / 9HYGR20.

	Capacity (kg)	Length (mm)	kg
--	---------------	-------------	----

<b>9TY621AB</b>	680	400	5.5
-----------------	-----	-----	-----



**9TY135150AB** £ 225.17<sup>B</sup>

**ENGINE STAND**

For working on disassembled engines. 4 adjustable arms (distance and inclination). Support pivots 360°. 5 wheels, including 3 guide wheels, and 2 brakes.

	Capacity (kg)	Minimum height (mm)	Length (mm)	Width (mm)	kg
<b>9TY135150AB</b>	680	880	870	825	33



**9TY61105AB** £141.51<sup>B</sup>

**ENGINE SUPPORT**

Easily supports the engine while removing the Transmission. Adjustable pad. The rubber pad prevents sliding while operation.

	Capacity (kg)	Length (mm)	kg
<b>9TY61105AB</b>	500	1500	22

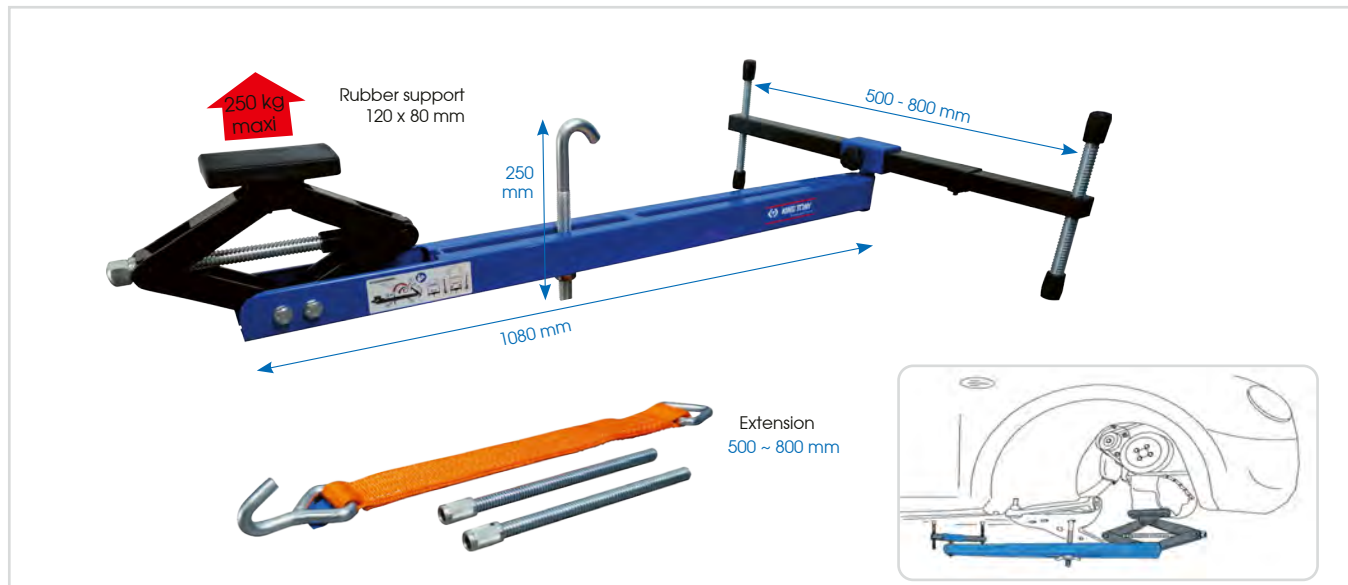

**9BJ2070** £461.91<sup>D</sup>

**ENGINE SUPPORT**

Provides engine or gearbox support when servicing cars and light commercial vehicles.

	Capacity (kg)	Height (mm)	Length (mm)	Width (mm)	kg
<b>9BJ2070</b>	250	120 ~ 260	1080	500	12





Please contact your retailer to get a quotation for these items.



9HYGR55  
9HYGR11



When folded the crane takes up a minimum of space on the workshop floor.



9HYGR20



5 positions = 5 capacities

	Position NO.1 (kg)	Position NO.2 (kg)	Position NO.3 (kg)	Position NO.4 (kg)	Position NO.5 (kg)
9HYGR55	550	500	450	400	350
9HYGR11	1100	1000	900	800	700
9HYGR20	2000	1900	1800	1700	1600

9HYGR

HYDRAULIC WORKSHOP CRANE

Folds away in seconds for quick and easy storage.  
Jib arm with large lifting capacity, even in 5th position.  
Hard chromium plated piston rod and pump piston for long life.  
Built-in safety overload valve.  
Fitted with 2 castors and 2 fixed wheels for easy manoeuvrability even with maximum load.  
Lifting hook pivots 360°.  
Hand operated dead man's release for optimum safety whilst lowering.

	Capacity (Ton)	Min. height (mm)	Max. height (mm)	Jib arm (mm)	Frame height (mm)	Frame length (mm)	Inner width (mm)	Frame width (mm)	Height (mm)	kg
9HYGR55	0.55 T	2020	2340	955 - 1375	125	1420	955	1080	1520	75
9HYGR11	1.10 T	2020	2340	955 - 1375	125	1420	985	1110	1520	95
9HYGR20	2.00 T	2340	2630	1210	160	1750	840	1020	1850	250

# EXCELLENCE SERIES

Structure  
GUARANTEED  
**10**  
YEARS

Hydraulic  
system  
GUARANTEED  
**3**  
YEARS



Please contact your retailer to get a quotation for these items.



Lifting arms with roller bearings for easy rotation of the wheel into correct position.

Pedal operated pump leaving both hands free for working.



## 9HYCM5

### HYDRAULIC WHEEL TROLLEY

Flexible and ergonomic wheel trolley for the easy removal of wheels and brake drums. Ideal for lifting brake drums, fuel tanks, tool boxes etc.

	Capacity (ton)	Lifting height (mm)	Minimum height (mm)	Length (mm)	Width (mm)	Height (mm)	Fork/rolls length (mm)	Distance between (mm)	For wheel diameter (mm)	Crane arm 9HYCMA1	kg
<b>9HYCM5</b>	0.5 T	710	95	870	990	1180	415 / 600	260 - 710	Ø 270-1300	○	100

Illustration with crane arm (optional)

○ Optional



**HANDLE**  
Wheel rotation system using the handle. The rollers use the wheel notches to turn the wheel on itself.

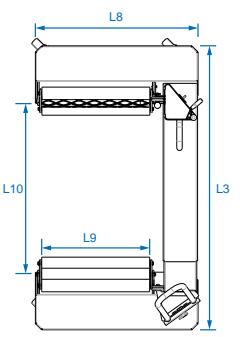

Great manoeuvrability thanks to four large robust swivelling wheels

## 9HYCM15V2

### HYDRAULIC WHEEL TROLLEY



Lever with hydraulic system to control the distance between the rollers that cause the lifting and lowering of the wheel.



Notched roll allowing the wheel to roll on itself



System to keep the wheel in place and aligned



Optimal user safety



Robust safety support to hold the wheel in place during transport

	Capacity (Ton)	Length L8 (mm)	Width L3 (mm)	Height H5 (mm)	Roller length L9 (mm)	Roller distance L10 (mm)	Roller diameter (mm)	For wheel diameter (mm)	kg
<b>9HYCM15V2</b>	1.5 T	1040	1635~2375	1455	690	900 - 1650	80	Ø 1000 - 2400	225





- Hydraulic lifting by pedal and progressive lowering by joystick allowing the platform to stop at the desired height.
- Easy to move thanks to its chrome hoop.
- Made of high strength steel.
- Safety valve built into the hydraulic cylinder to prevent overloading.

**9TYC11**

**SINGLE SCISSOR HYDRAULIC LIFTING TABLE**

	Capacity (kg)	Minimum height (mm)	Maximum height (mm)	kg	
9TYC11015AB	150	225	740	44	£ 298.15 <sup>D</sup>
9TYC11050AB	500	340	900	87	£ 449.45 <sup>D</sup>
9TYC11100AB	1000	420	1000	115	£ 978.11 <sup>D</sup>

**9TYC12**

£ 553.58<sup>D</sup>

**SINGLE SCISSOR HYDRAULIC LIFTING TABLE**

	Capacity (kg)	Minimum height (mm)	Maximum height (mm)	kg
9TYC12035AB	350	350	1300	105

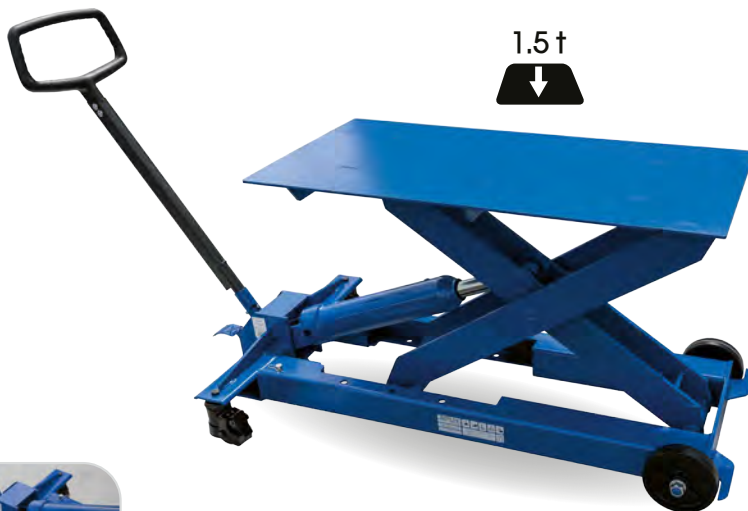

Quick-lift pedal



Noiseless wheels



**9TYC1101500**

£ 1,823.61<sup>D</sup>

**HYDRAULIC LIFTING TABLE**

Allows lifting, lowering and possibly moving over short distances loads weighing up to 1.5 tonnes.  
"Quick-lift" pump pedal for a quick approach.

	Capacity (kg)	Minimum height (mm)	Maximum height (mm)	kg
9TYC1101500	1.5 T	210	880	130



9TYN1436

TRANSMISSION JACK

2-speeds plastic handle.  
Pedal with rubber coating.  
Dust protection. Double pumps.  
Fiberglass and nylon wheel.  
Chrome-plated piston rod for long service life.  
Safety overload valve.

	Capacity (kg)	Minimum height (mm)	Maximum height (mm)	kg	
9TYN143603AB	300	1140	2000	28.1	£ 388.04 <sup>D</sup>
9TYN143606AB	600	1146	1986	34.8	£ 453.90 <sup>D</sup>
9TYN143610AB	1000	1170	2010	39.8	£ 496.62 <sup>D</sup>

9TY145

£ 474.37<sup>D</sup>

TRANSMISSION JACK

Handle for easy adjustment.  
Safety overload valve.  
Pedal for hydraulic control.  
Strong steel base.  
Nylon wheels.

	Capacity (kg)	Minimum height (mm)	Maximum height (mm)	kg
9TY145015AB	1500	1130	1915	55.5



Ratchet clamp  
25 x 130 mm

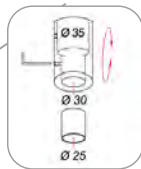

Cylinder adapter:  
ø 25, ø 30, ø 35 mm



9TYVS1

£ 354.22<sup>D</sup>

SUPPORT SADDLE

Designed to facilitate the dismantling and positioning of the gearbox on cars and light commercial vehicles.

	Capacity (kg)	Height (mm)	Length (mm)	Width (mm)	kg
9TYVS1	150	300	450	310	8



## AXLE STANDS



**PRO SERIES**  
★ ★ ★



Always support the vehicle on axle stands before working under it.  
Never stay in or get on a raised vehicle or under one held only by a jack.

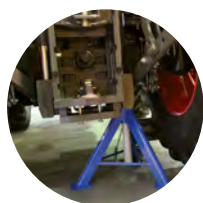

### 9TY321

#### SET OF 2 STANDARD AXLE STANDS

Robust for maximum stability and life.  
Adjustable height.

	Capacity (Ton)	Minimum height (mm)	Maximum height (mm)	Pair weight (kg)	
9TY32103A	3 T	375	555	9.0	£ 59.63 <sup>D</sup>
9TY32105A	5 T	455	665	24.8	£ 173.55 <sup>D</sup>

### 9TY332

#### SET OF 2 SCREW TYPE AXLE STANDS

Easy to use axle stands. Quickly and precisely adjust the height using the screw. Suitable for almost all types of vehicle.  
Robust for maximum stability and a long service life.

	Capacity (Ton)	Minimum height (mm)	Maximum height (mm)	Pair weight (kg)	
9TY33220AB	20 T	420	600	50.8	£ 585.62 <sup>D</sup>
9TY33221AB	20 T	665	1090	78.8	£ 774.30 <sup>D</sup>



- Welded steel for more safety & robustness.
- Adjustable height.



### 9TYE342

#### SET OF 2 RATCHETING AXLE STANDS

	Capacity (Ton)	Minimum height (mm)	Maximum height (mm)	Pair weight (kg)	
9TYE34203AB	3 T	291	430	6.8	£ 52.51 <sup>D</sup>
9TYE34206AB	6 T	390	610	12.6	£ 114.81 <sup>D</sup>

### 9TYE351

#### SET OF 2 AXLE STANDS BASE SQUARE

	Capacity (Ton)	Minimum height (mm)	Maximum height (mm)	Pair weight (kg)	
9TYE35112AB	12 T	300	450	40.4	£ 225.17 <sup>D</sup>
9TYE35122AB	22 T	311	505	64.0	£ 248.31 <sup>D</sup>

## HANDLING TROLLEY



### 9TYE722AB

£ 309.72 <sup>D</sup>

#### SET OF 2 HANDLING TROLLEYS

Lifting of the vehicle thanks to a pedal.  
4 steering wheels; 2 with brakes.  
Aluminium rollers.

	Capacity (kg)	Distance between rolls (mm)	Max tire width (inch - mm)	Pair weight (kg)
9TYE722AB	680/trolley	270 - 650	13" - 330 mm	32.2

## BOTTLE JACKS



Always support the vehicle on axle stands before working under it. Never stay in or get on a raised vehicle or under one held only by a jack.



### 9TY111

#### HYDRAULIC BOTTLE JACKS WITH SINGLE LIFT ARM AND EXTENSION SCREW

All models can be used from -20°C to 70°C  
Can also be used horizontally as a pressure cylinder  
The piston pump must be placed below the jack  
Integrated safety valve. Galvanised pump handle.  
With a raised column to fully benefit from the length of the extension

	Capacity (Ton)	Minimum height (mm)	Maximum height (mm)	Hydraulic lifting (mm)	Column (mm)	kg	
9TY111035A	3.5 T	172	372	112	88	3.7	£ 61.41 <sup>B</sup>
9TY11105A	5 T	212	468	146	110	4.9	£ 68.53 <sup>B</sup>
9TY11110A	10 T	220	483	148	115	7.3	£ 98.79 <sup>B</sup>
9TY11115A	15 T	231	498	154	113	9.8	£ 120.15 <sup>B</sup>
9TY11120A	20 T	241	521	165	115	13.1	£ 147.74 <sup>B</sup>
9TY11130A	30 T	244	510	266	110	47.3	£ 162.87 <sup>B</sup>

## PNEUMATIC BALLOON JACKS

### PRO SERIES



Safety valve.  
4 thickness membrane.  
Cylinder guide ring for smooth operation and long service life.  
Automatic reminder switch with ergonomic design, safe and easy to use.  
2 triggers : 1 for lifting, 1 for releasing



The balloon jacks are compact, easy to use while offering a large lifting range.

**2 TON**

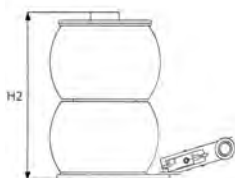
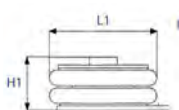
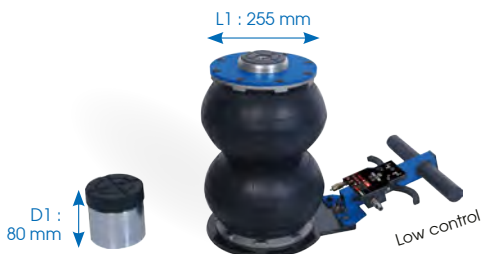

**2 TON**



9TYN24302AB



£542.01<sup>D</sup>

2 STAGE PNEUMATIC BALLOON JACK (2 T)

9TYN24102AB



£606.09<sup>D</sup>

2 STAGE PNEUMATIC BALLOON JACK (2 T)

**2 TON**

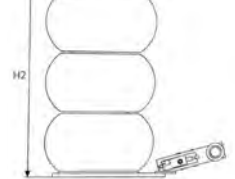
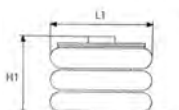

**2 TON**



9TYN24402AB



£623.00<sup>D</sup>

3 STAGE PNEUMATIC BALLOON JACK (2 T)

9TYN24202AB



£633.68<sup>D</sup>

3 STAGE PNEUMATIC BALLOON JACK (2 T)

	Capacity (ton)	Minimum height H1 (mm)	Maximum height H2 (mm)	Lifting height (mm)	Max height (mm)	Thickness of the membrane (mm)	Air Pressure (bar)	kg
9TYN24302AB	2 T	115	350	235	430	7-7,5	7 ~ 10	15.00
9TYN24102AB	2 T	115	350	235	430	7-7,5	7 ~ 10	18.00
9TYN24402AB	2 T	200	500	300	560	7-7,5	7 ~ 10	17.00
9TYN24202AB	2 T	200	500	300	560	7-7,5	7 ~ 10	19.84

# HYDRAULIC JACKS

## EXCELLENCE SERIES



Always support the vehicle on axle stands before working under it. Never stay in or get on a raised vehicle or under one held only by a jack.



Please contact your retailer to get a quotation for these items.

**2 TON**

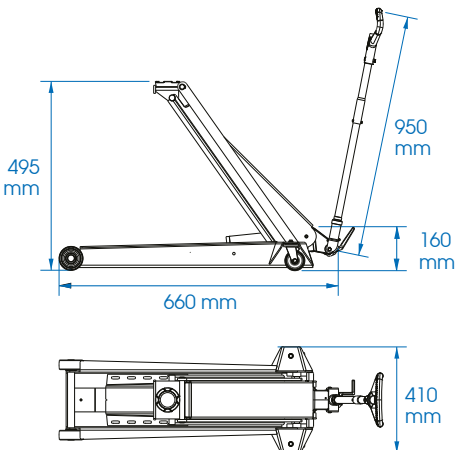

OPTIONAL 9HYCRAT



Quick-lift pedal



Noiseless wheels



### 9HYCR2

#### HIGH LIFTER WITH LONG REACH HYDRAULIC JACK

Ideal for passenger cars and vans.  
 Low minimum height of only 80 mm.  
 Wide and robust frame made of high-strength steel.  
 With quick lift footswitch.  
 Precise and safe control whilst lowering.  
 Manual dead man's release for optimum safety when lowering.  
 Built-in safety overload valve.  
 Noiseless wheels incorporating a polyurethane central O ring offers maximum surface protection.  
 Ergonomically designed handle ensuring positive and safe operation.

	Capacity (Ton)	Min. height (mm)	Max. height (mm)	Frame length (mm)	Handle length (mm)	Frame height (mm)	Width (mm)	kg
9HYCR2	2 T	80	495	660	950	160	410	31

## PRO SERIES



### 9TYE13303AB

£575.83<sup>D</sup>

#### OFF ROAD JACK

Suitable for off-road vehicles, utility vehicles, mid size trucks.



**+** Off-road. Heavy duty.

**3 TON**



The extension can be installed or removed quickly and easily, making the jack versatile and time-saving.

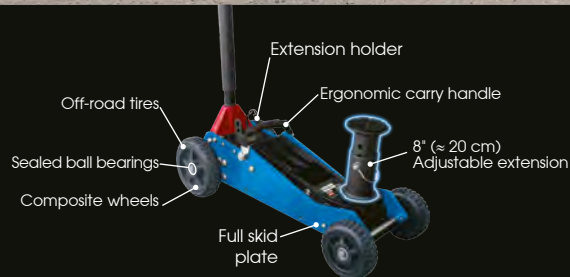

	Capacity (Ton)	Minimum height (mm)	Maximum height (mm)	kg
9TYE13303AB	3 T	165	730	29



# PRO SERIES

**!** Always support the vehicle on axle stands before working under it. Never stay in or get on a raised vehicle or under one held only by a jack.

## 9TYN13402AB

### HYDRAULIC TROLLEY JACK

The low profile is suitable for more types of vehicles. Handle with dead man device (automatic turning handle).



**2 TON**



## 9TYN13102AB

### HYDRAULIC TROLLEY JACK

Handle with dead man device (automatic turning handle). Ergonomic handle with 2 hands.



**2 TON**



## 9TYE13325AB

### HYDRAULIC TROLLEY JACK

Low minimum height for lower vehicles. Ergonomic non-slip handle.



**2.5 TON**



## 9TYN13

### HYDRAULIC TROLLEY JACK

Handle with dead man device (automatic turning handle). Ergonomic handle with 2 hands.



9TYN13302AB  
**2 TON**

9TYN13303AB  
**3 TON**



## 9TYE13110AB

### HYDRAULIC TROLLEY JACK

Speed control. Safety valve to avoid overloading.



**10 TON**



## 9TYE13120AB

### HYDRAULIC TROLLEY JACK

Speed control. Safety valve to avoid overloading.

**20 TON**



	Capacity (Ton)	Minimum height (mm)	Maximum height (mm)	Frame length (mm)	Frame height (mm)		
9TYN13302AB	2T	75	500	770	264	32.9	£337.31 <sup>D</sup>
9TYN13303AB	3T	95	515	770	284	39.5	£372.91 <sup>D</sup>
9TYE13325AB	2.5T	75	510	-	-	30.5	£212.71 <sup>D</sup>
9TYN13402AB	2T	75	530	970	197	42.2	£376.47 <sup>D</sup>
9TYN13102AB	2T	85	780	1010	285	54.18	£497.51 <sup>D</sup>
9TYE13110AB	10T	160	560	1545	-	133	£1,008.37 <sup>D</sup>
9TYE13120AB	20T	185	620	1600	-	241	£2,588.12 <sup>D</sup>



Always support the vehicle on axle stands before working under it. Never stay in or get on a raised vehicle or under one held only by a jack.



Please contact your retailer to get a quotation for these items.

SPECIAL HIGH LIFT



25 TON

1-stage

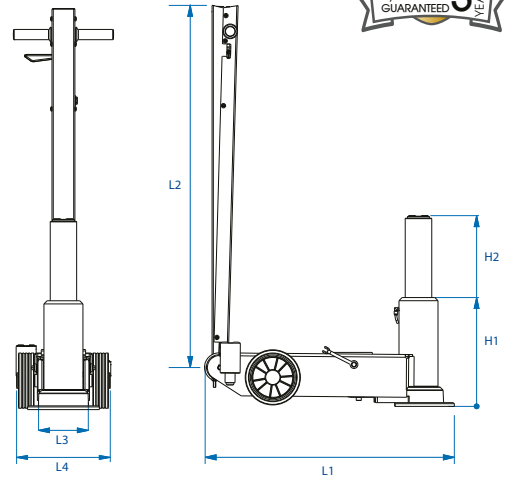

9HYCH125H

SINGLE STAGE AIR HYDRAULIC JACK

Foldable handle.  
Protection of the pneumatic casings in the handle. Complete protection of the hydropneumatic system.  
Hard chromium plated piston rod for long life.  
Hand-operated dead-man's control for optimum safety whilst lifting and lowering.  
Built-in safety overload valve.  
With 2 extensions (50/100 mm).



Capacity (Ton)	Minimum height H1 (mm)	Maximum height H2 (mm)	Frame length L1 (mm)	Handle length L2 (mm)	Width with wheels L4 (mm)	Width L3 (mm)	Air supply (bar)	Air consumption (L/min)	kg	Extension 9HYCHR25	Saddle 9HYCHOP1
25 T	360	610	820	1160	310	230	8 - 10	350	71	○	○

○ Optional



10/25 TON



9HYCHP225

PORTABLE AIR HYDRAULIC JACK

Low minimum height of only 160 mm and low weight of only 28 kg.  
Handy design - no loose tubes, handles or valves.  
Easy to operate - handle can be used for carrying, lifting, lowering and manoeuvring.  
Hard chromium plated piston rod for long life.  
Hand-operated dead-man's control for optimum safety whilst lifting and lowering.  
Built-in safety overload valve.  
With 2 extensions (50/100 mm).

Capacity (Ton)	Minimum height (mm)	Maximum height (mm)	Frame length (mm)	Handle length (mm)	Width with wheels (mm)	Width (mm)	Air supply (bar)	Air consumption (L/min)	kg	Extension 9HYCHR25	Saddle 9HYCHOP1
25 / 10 T	160	235 / 320	535	550	290	225	8 - 10	350	28	○	○

○ Optional



# PRO SERIES

**!** Always support the vehicle on axle stands before working under it. Never stay in or get on a raised vehicle or under one held only by a jack.



## 9TYN231

### SINGLE STAGE AIR HYDRAULIC JACKS

Slowdown valve.  
Overload safety valve.  
Automatic reminder switch for safe work.  
With 2 extensions (9TYN23130AB : 45 and 100 mm, 9TYN23160AB : 100 and 200 mm).

- Supply pressure (bar) : 9 ~ 12

30 TON

60 TON



9TYN23130AB



9TYN23160AB

	Capacity (Ton)	Minimum height (mm)	Maximum height (mm)	kg	
9TYN23130AB	30 T	360	627	86	£2,203.64 <sup>D</sup>
9TYN23160AB	60 T	420	731	126	£2,667.33 <sup>D</sup>



## 9TYN23

### 2-STAGE AIR HYDRAULIC JACKS

Slowdown valve.  
Overload safety valve.  
Automatic reminder switch for safe work.  
With 2 extensions (45 and 75 mm).

- Supply pressure (bar) : 9 ~ 12

10/25 TON

25/50 TON

40/60 TON



9TYN23125AB 49



9TYN23150AB 67



9TYN23260AB 82

	Capacity (Ton)	Minimum height (mm)	Maximum height (mm)	
9TYN23125AB	10 T 25 T	183	279 (10 T) 374 (25 T)	£ 1,716.81 <sup>D</sup>
9TYN23150AB	25 T 50 T	215	444 (25 T) 330 (50 T)	£ 1,866.33 <sup>D</sup>
9TYN23260AB	40 T 60 T	220	460 (40 T) 341 (60 T)	£ 2,123.54 <sup>D</sup>



15/30/50 TON



## 9TYN23250AB

£1,879.68<sup>D</sup>

### 3-STAGE AIR HYDRAULIC JACK

Slowdown valve.  
Overload safety valve.  
Automatic reminder switch for safe work.  
With 2 extensions (45 and 75 mm).

- Supply pressure (bar) : 9 ~ 12

	Capacity (Ton)	Minimum height (mm)	Maximum height (mm)	kg
9TYN23250AB	15 T 30 T 50 T	150	312 (15 T) 252 (30 T) 203 (50 T)	56



15/30 TON



## 9TYN23330AB

£ 1,457.82<sup>D</sup>

### PORTABLE AIR HYDRAULIC JACK

Ideal for on road repairs.  
Slowdown valve.  
Overload safety valve.  
With 2 extensions (45 and 75 mm).

- Supply pressure (bar) : 9 ~ 12

	Capacity (Ton)	Minimum height (mm)	Maximum height (mm)	kg
9TYN23330AB	15 T 30 T	150	224 (15 T) 293 (30 T)	32





20  
TON



30  
TON



50  
TON

9TYN51420AB £1,553.05<sup>D</sup>

9TYN51430AB £1,984.70<sup>D</sup>

9TYN51450AB £2,749.21<sup>D</sup>



V block and 180° configuration



Sliding cylinder with handle and positioning scale

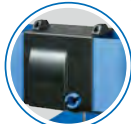

Winch protection cover



Winch handle support

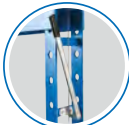

Handle support



Pulley protective cover



Pulley protection cover for hand safety



Pulley protective cover



Screw extension



PUNCH SET  
Included with:  
9TYN51420AB  
9TYN51430AB  
9TYN51450AB



100  
TON

9TYN514A0AB £5,700.45<sup>D</sup>

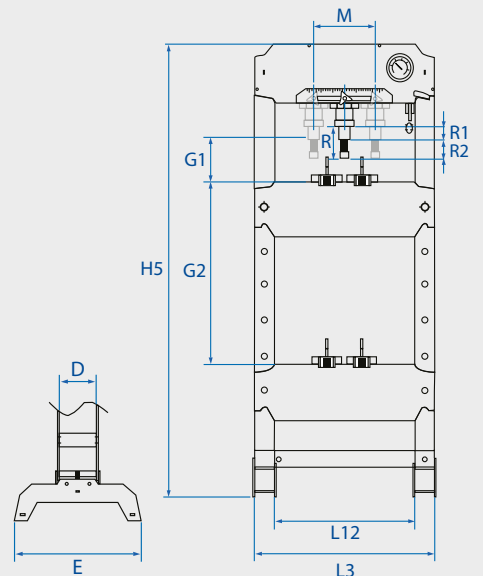

SINGLE STAGE AIR HYDRAULIC JACKS

- Safety valve.
- Pneumatic and manual double speed pump.
- Pneumatic foot pedal.
- Swivel handle and handle support for winch.
- Ergonomics handle & Handle holder.

• Supply pressure (bar) : 9 ~ 12

	Capacity (ton)	D (mm)	E (mm)	G1 (mm)	G2 (mm)	R2 (mm)	R1 (mm)	R (mm)	M (mm)	Width L3 (mm)	Height H5 (mm)	Width between feet L12 (mm)	kg
9TYN51420AB	20 T	152	505	25	850	75	145	220	200	770	1800	600	132
9TYN51430AB	30 T	200	535	130	830	75	145	220	280	930	1900	750	210
9TYN51450AB	50 T	200	535	80	780	75	145	220	280	930	1900	750	249.2
9TYN514A0AB	100 T	280	750	185	855	-	-	300	360	1255	1938	850	677

# PRO SERIES



To be installed on the work surface.

- Screen made of polycarbonate with high impact resistance.
- Maximizes operator safety.



Compatible with



Model	Capacity (kg)	Price (£)
9TYN51420P01A	5	£114.81
9TYN51430P01A	6	£125.49
9TYN51450P01A	6	£123.71
9TYN514A0P01A	12.75	£274.12



The pin set can be installed on the frame of the press.

3.5

## 9TYN514A0P02A

£93.45

### PRESS TOOL KIT

Different capacity included in the set 2t, 3t, 6t, 8t, 10t, 12t, 13t, and 15t.

Capacity (ton)	Length (mm)	Ø (mm)
2 T	60	10
3 T	60	12
6 T	60	16
8 T	85	18
10 T	85	20
12 T	85	22
13 T	110	25
15 T	108	30

Compatible with:

9TYN51420AB / 9TYN51430AB / 9TYN51450AB / 9TYN514A0AB

**!** Pneumatic approach, manual press (12 bars max.)

# EXCELLENCE SERIES



Structure GUARANTEED 10 YEARS

Hydraulic system GUARANTEED 3 YEARS

**?** Please contact your retailer to get a quotation for these items.



Winch operated press table. Optional chain driven traction for lifting / lowering of the plate with the cylinder (9HYP1400).

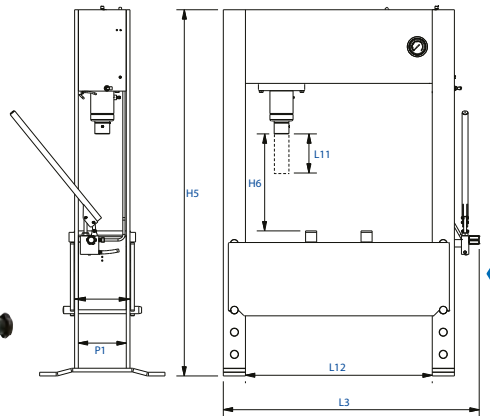

Foot-operated, double-acting, pneumatically controlled and high speed, leaving both hands free for quick and precise positioning of the item.

## 9HYP40

### HAND HYDRAULIC PRESS

- With 300 mm stroke for dealing with demanding jobs
- Supplied with 2 vee blocks
- Built-in safety overload valve
- Removable ram end cap for mounting various piston heads
- Welded frame and press table made from high strength for long life

Model	Capacity (Ton)	Width L3 (mm)	Height H5 (mm)	Stroke L11 (mm)	Width between legs L12 (mm)	Depth between legs P1 (mm)	Clearance H6 (mm)	Weight (kg)	Lifting chain 9HYP1400	Kit 9HYPA3	Safety screen 9HYPP40
9HYP40	40 T	1190	1740	300	850	215	85 - 785	425	○	○	○

○ Optional





**An exceptional partnership  
bringing together quality and innovation!**



# THE NEW M7 PROMOTIONAL CATALOGUE HAS ARRIVED.



**2026  
CATALOGUE**



catalog.kingtony.eu



 [kingtonyeurope.com](http://kingtonyeurope.com)

 [service-clients@kingtony.eu](mailto:service-clients@kingtony.eu)

 +33 5 49 30 33 27

