





# SUMMARY

## HAND SOCKETS ..... p. 2 to 5

Ratchets and Articulated handles..... p. 2/3  
 Socket racks..... p. 3  
 Socket sets..... p. 4/5

## IMPACT SOCKETS ..... p. 6

## PNEUMATIC IMPACT WRENCHES ..... p. 6

## WRENCHES ..... p. 7/8

## PLIERS ..... p. 9

## SCREWDRIVERS, L-WRENCHES AND BITS ..... p. 10/11

## PIPE TOOLS ..... p. 12

## TOOLS FOR ELECTRONICS AND ELECTRICITY ..... p. 12 to 14

## 1000 V INSULATED TOOLS ..... p. 15

## HAMMERS AND STRIKING TOOLS ..... p. 16

## WORKSHOP TOOLS ..... p. 16/17

## LIGHTING ..... p. 18/19

## STORAGE AND TOOL SETS ..... p. 20 to 34

Nomadic Storage ..... p. 20/25/26  
 Metal tool chests..... p. 26  
 Tool Trolleys..... p. 27  
 Workshop storage..... p. 28  
 Evawave foam tray sets..... p. 29/30  
 Tools sets ..... p. 31 to 34

## TORQUE CONTROL ..... p. 35/36

## DRILL BIT, TAP, DIE ..... p. 36

## PULLERS ..... p. 36/37

## AUTOMOTIVE TOOLS ..... p. 38 to 41

Lubrication..... p. 38  
 Cleaning ..... p. 38  
 Drain - filtration..... p. 38  
 Front axle..... p. 38  
 Wheels..... p. 39  
 Engine..... p. 39  
 Accessories..... p. 40  
 Coolant..... p. 40  
 Suspension..... p. 40  
 Brakes..... p. 40  
 Bodywork..... p. 41  
 Alternator ..... p. 41  
 Spark plugs..... p. 41

## HYDRAULIC - LIFTING ..... p. 42 to 44

# RATCHETS AND ARTICULATED HANDLES

LIFETIME GUARANTEE

At least **30%** above the DIN and AISI standards

- Materials:
  - body in Cr-V
  - square drive in Cr-Mo
- Finishes:
  - polished and chrome body
  - black phosphate square drive



**276B0225** 87.6 mm 1/4" **€30**<sup>B</sup>

1/4" MINI BIT HOLDER & SOCKET HOLDER RATCHET SET



**275245G** 114 mm 1/4" **€29**<sup>B</sup>

MINI SWIVEL HEAD RATCHET WITH ARTICULATED HANDLE



**276955P** 140 mm 1/4" **€21**<sup>B</sup>

REVERSIBLE RATCHET



**17773GS** **€53**<sup>B</sup>

1/4" & 1/2" DR I-BEAM DUST-PROOF RATCHET SET

2 PC.

1/2"

1/4"

**IP51**

Protection against dust and condensation

**I-beam**

Quick release of the socket

Steel retainer ball

Reversible

I-beam design

Non-slip PP+TPR handle

**277355GS** 140 mm 1/4" **€28**<sup>B</sup>

**477310GS** 250 mm 1/2" **€33**<sup>B</sup>

90°  
4°



**27555G** 140 mm 1/4" **€29**<sup>B</sup>

**375508G** 200 mm 3/8" **€27**<sup>B</sup>

**475510G** 250 mm 1/2" **€30**<sup>B</sup>

REVERSIBLE RATCHET



**277155G** 130 mm 1/4" **€23**<sup>B</sup>

**377108G** 200 mm 3/8" **€30**<sup>B</sup>

**477110G** 200 mm 1/2" **€31**<sup>B</sup>

REVERSIBLE RATCHET



600 mm

450 mm

180°

**446124G** 450 ~ 600 mm 1/2" **€43**<sup>B</sup>

ARTICULATED AND EXTENDABLE HANDLE

+150 mm

180°

**646240P** 1020 mm 3/4" **€117**<sup>B</sup>

ARTICULATED HANDLE

3.90

**846240P** 1020 mm 1" **€129**<sup>B</sup>

ARTICULATED HANDLE

3.95



## RATCHETS AND ARTICULATED HANDLES

LIFETIME GUARANTEE

Materials:  
- body in Cr-V  
- square drive in Cr-Mo

Finishes:  
- polished and chrome body  
- black phosphate square drive

At least **30%** above the DIN and AINSI standards

**New**

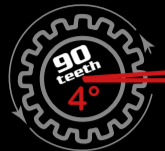

**477322GS €88<sup>B</sup>**

**1/2" TELESCOPIC RATCHET**

Higher torque, less effort. Extra long lever for increased power: max 550 mm.  
700 Nm torque value, which far exceeds the standard.

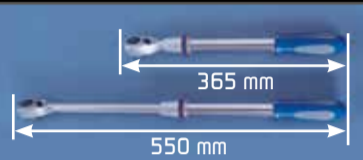

Protection against dust and condensation



**New**



included in the new 24-piece set

**4524MRV04KP 05**

## SOCKET RACKS

LIFETIME GUARANTEE



**2127SR €15<sup>B</sup>**

1/4" ● H1/8, H5/32, H3/16, H7/32, H1/4, H5/16, H3/8

**2509MR €9<sup>B</sup>**

1/4" ○ 4, 5, 6, 7, 8, 9, 10, 11, 13 mm

**4105PR €35<sup>B</sup>**

1/2" ● M8, M10, M12, M14  
○ M16

**2011SR €17<sup>B</sup>**

1/4" ○ 5/32", 3/16", 7/32", 1/4", 9/32", 5/16", 11/32", 3/8", 7/16", 15/32", 1/2"

**2127PR €12<sup>B</sup>**

1/4" ● H3, H4, H5, H6, H7, H8, H10

**2109PR €15<sup>B</sup>**

1/4" ● T8, T9, T10, T15, T20, T25, T27, T30, T40

**2114TR €24<sup>B</sup>**

1/4" ● T8, T9, T10, T15, T20, T25, T27, T30, T40  
● E4, E5, E6, E7, E8

**4421MP €58<sup>B</sup>**

1/2" ○ 10, 11, 13, 17, 19, 22, 24, 27, 29, 30, 32 mm

**7411PP €77<sup>B</sup>**

3/8" ● E5, E6, E7, E8  
1/2" ● E10, E12, E14, E16, E18, E20  
1/2" → 3/8"



**4108PR10 €38<sup>B</sup>**

1/2" ● H6, H7, H8, H10, H12, H14, H17, H19

**4116PR €64<sup>B</sup>**

1/2" ● M9, M10, M12, M13, M14, M16

**4510MR €24<sup>B</sup>**

1/2" ○ 10, 12, 13, 14, 17, 19, 21, 22 mm

**4010SR €25<sup>B</sup>**

1/2" ○ 3/8", 7/16", 1/2", 9/16", 11/16", 3/4", 13/16", 7/8"

**7113PR €38<sup>B</sup>**

3/8" ● E4, E5, E6, E7, E8, E11  
1/2" ● E10, E12, E14, E16, E18, E20

**3118PR €36<sup>B</sup>**

3/8" ● T15, T20, T25, T27, T30, T40, T45, T50



**IMPACT SOCKETS**



HAND SOCKETS

LIFETIME GUARANTEE

CHROME VANADIUM

At least 30% above the DIN and AISI standards

LIFETIME GUARANTEE



Rubber ring on all the 1/2", 3/4" and 1" sockets



METRIC SIZE



IMPERIAL SIZE

Metal boxes



26 PC.

**2526SR02** 1/4" €68 B

244 x 118 x 37 mm

Contents		1.38
2335S	5/32", 3/16", 7/32", 1/4", 9/32", 5/16", 11/32", 3/8", 7/16", 15/32", 1/2"	
2235S	5/32", 3/16", 7/32", 1/4", 9/32", 5/16", 11/32", 3/8", 7/16", 1/2"	
2221	55, 100 mm	
275555G	2792	2813



31 PC.

**2531MR03** 1/4" €79 B

280 x 130 x 41 mm

Contents		1.60
2335M	4, 4.5, 5, 6, 7, 8, 9, 10, 11, 12, 13	
2033	T8, T9, T10, T15, T20, T25, T27, T30	
2035	H3, H4, H5, H6, H8, H10	
275555G	257145	
2792	2179DF	
222103, 222106		



51 PC.

**2551MR** 1/4" €79 B

244 x 118 x 37 mm

Contents		1.43
2335M	4, 5, 5.5, 6, 7, 8, 9, 10, 11, 12, 13, 14	
1025S	3.0, 4.0, 5.0, 6.0	
1025P	PH1, PH2, PH2, PH3	
1025Z	PZ1, PZ2, PZ2, PZ3	
1025T	T10, T15, T20, T25, T27, T30, T40	
1025U	T10H, T15H, T20H, T25H, T27H, T30H, T40H	
1025H	H3, H4, H5, H6	
2223	50, 100 mm	
275555G	2178DF	2142
2792	770225	75363
		2813



25 PC.

**6325MR01** 3/4" €416 B

537 x 177 x 78 mm

Contents		18.7
6335M	19, 21, 22, 23, 24, 26, 27, 28, 29, 30, 32, 34, 35, 36, 38, 41, 46, 50, 55	
6251	100, 200, 400	
677820F	657220	6791



15 PC.

**8015MR** 1" €619 B

660 x 205 x 108 mm

Contents		34.5
8330M	36, 41, 46, 50, 55, 60, 65, 70, 75, 80	
8251	200, 400	
877932F	857225	



9 PC.

198 x 105 x 32 mm

Contents		1.03
T20, T25, T27, T30, T40, T45, T50, T55, T60		

**4109PR** 1/2" €59 B



20 PC.

**4220MR** 1/2" €117 B

445 x 135 x 50 mm

Contents		3.83
4330MR	8, 9, 10, 11, 12, 13, 14, 15, 16, 17, 18, 19, 21, 22, 24, 27	
475510G	4791	
457210	425105, 425110	



24 PC.

**4526SR04** 1/2" €149 B

445 x 187 x 50 mm

Contents		5.95
4335S	5/16", 3/8", 7/16", 15/32", 1/2", 9/16", 19/32", 5/8", 11/16", 3/4", 25/32", 13/16", 7/8", 15/16", 1", 1-1/16", 1-3/16", 1-1/4"	
4251	125, 250 mm	
475510G	4791	
445215F	457212	



ATOM Series

39 PC.



25 PC.

**2525MRE** 1/4" €34 B

203 x 93 x 43 mm

Contents		0.55
2335M	4, 4.5, 5, 5.5, 6, 7, 8, 9, 10, 11, 12, 13	
1025P	PH2, PH2	
1025H	H5, H6	
1025T	T10, T15, T20, T25, T30, T40	
277155G	2142	222104



44 PC.

**2044SRE** 1/4" €99 B

Case 820002K (389 x 185 x 66 mm) EVA #10 (375 x 140 mm)

Contents		1.62
2330S	5/32", 3/16", 7/32", 1/4", 9/32", 5/16", 11/32", 3/8", 7/16", 15/32", 1/2"	
2235S	5/32", 3/16", 7/32", 1/4", 9/32", 5/16", 11/32", 3/8", 7/16", 1/2"	
5025H	H3/64", H1/16", H5/64", H3/32", H7/64", H1/8", H9/64", H5/32"	
1025S	3.0, 4.5, 5, 6.5, 8	
1025P	PH0, PH1, PH2, PH3	
2223	50, 100 mm	
275206G	2792	2142
2178DF		



39 PC.

**2539MRV04** 1/4" €66 B

199 x 161 x 56 mm

Contents		1.25
2335M	5, 6, 7, 8, 9, 10, 11, 12, 13, 14	
1025S	4.0 x 0.5, 5.5 x 0.8, 6.5 x 1.2	
1025P	PH1, PH2	
1025Z	PZ2	
1025U	T7H, T8H, T9H, T10H, T15H, T20H, T25H, T27H, T30H, T40H	
1025H	H1.5, H2, H2.5, H3, H4, H5, H6	
1317012PN	PH1	PH2
1317046SN	4.0	6.0
1317057SN	5.0	7.0
770225	215506	
2155DF		



72 PC.

**2572MRE** 1/4" €139 B

Case 820003K (389 x 230 x 66 mm) EVA #8 (375 x 187 mm)

Contents		2.06
2335M	4, 5, 6, 7, 8, 9, 10, 11, 12, 13, 14	
2235M	6, 7, 8, 9, 10, 11, 12, 13	
2375M	E4, E5, E6, E7, E8	
2033	T8, T9, T10, T15, T20, T25, T27, T30, T40	
2035	H3, H4, H5, H6	
2037	T20, T25, T30, T40	
1025P	PH0, PH1, PH2 6mm, PH3	
1025Z	PZ1, PZ2, PZ3	
1025H	H3, H4, H5, H6	
1025T	T10, T15, T20, T25, T27, T35, T40	
1025U	T15H, T20H, T25H, T27H, T30H, T40H	
2223	50, 100 mm	
277355GS	2746	
2178DF	2792	2142

**2539MR01AM** 1/4" €69 B

175 x 98.5 x 55 mm

Contents		0.86
2335M	5, 5.5, 6, 7, 8, 9, 10, 11, 12, 13, 14	
1025P	PH1, PH2, PH3	
102512P	PH2	
1025Z	PZ1, PZ2, PZ3	
1025U	T10H, T15H, T20H, T25H, T27H, T30H, T40H	
1025S	4.0, 5.0, 6.0	
1025H	H2.5, H3, H4, H5, H6	
277355GS	2176DF	
2141	2793	222102, 222104





# HAND SOCKETS

LIFETIME GUARANTEE

**THINK ABOUT IT!** 11 PC.

**91000M** €15.50 <sup>B</sup>

**MAGNETIC HEXAGONAL INSERT SET FOR METRIC SOCKETS**

For 6-point or 12-point metric sockets.

**91000M** Gift icon

**New telescopic ratchet included** 03

**4524MRV04KP** €229 <sup>B</sup> 1/2" 24 PC. **New**

Case 820003K (389 x 230 x 66 mm). EVA #8 (375 x 187 mm).

Contents 5.08

	4335M	8, 10, 11, 12, 13, 14, 15, 16, 17, 18, 19, 21, 22, 23, 24, 27, 28, 30, 32
	477322GS	4793
	457212	

+185 mm

**3523MRE09** 3/8" €91 <sup>B</sup> 23 PC. 3/8"

Case 820002K (389 x 185 x 66 mm)  
EVA #10 (375 x 140 mm)

Contents 2.43

	3335M	6, 7, 8, 9, 10, 11, 12, 13, 14, 15, 16, 17, 19, 21, 22, 23, 24
	375508G	
	3293	75, 150 mm
	445215F	3792
	345208G	357108

**4532MRE10** 1/2" €237 <sup>B</sup> 32 PC.

Case 820011K (422 x 372 x 92 mm)  
EVA #9 (375 x 280 mm)

Contents 6.34

	4335M	8, 9, 10, 11, 12, 13, 14, 15, 16, 17, 18, 19, 20, 21, 22, 23, 24
	4235M	10, 13, 16, 17, 18, 19, 21, 22, 24
	4251	125, 250 mm
	477310GS	445315F (H-BEAM)
	457212	4791

**9TA56A** Gift icon 27 PC.

**4527MRE01P** 1/2" €204 <sup>B</sup>

**4527MRE02P** 1/2" €204 <sup>B</sup>

Case 820011K (422 x 372 x 92 mm)  
EVA #9 (375 x 280 mm)

Contents 6.11

	4335M	8, 9, 10, 11, 12, 13, 14, 15, 16, 17, 18, 19, 21, 22, 23, 24, 27, 29, 30, 32
	4527MRE01	476510G
	4527MRE02	477110G
	4251	125, 250 mm
	445215F	4791
	457212	458110

**4546MRE02** 1/2" €303 <sup>B</sup> 46 PC.

Case 820011K (422 x 372 x 92 mm)  
EVA #9 (375 x 280 mm)

Contents 7.14

	4335M	8, 9, 10, 11, 12, 13, 14, 15, 16, 17, 18, 19, 20, 21, 22, 23, 24
	4023	T20, T25, T27, T30, T40, T45, T50, T55, T60
	4025	H4, H5, H6, H7, H8, H10, H12, H14, H17, H19
	4026	M8, M10, M12, M14
	4251	125, 250 mm
	477310GS	445315F (H-BEAM)
	457212	4791

**4523MRE01** 1/2" €123 <sup>B</sup> 23 PC.

Case 820003K (389 x 230 x 66 mm)  
EVA #8 (375 x 187 mm)

Contents 3.88

	4335M	8, 9, 10, 11, 12, 13, 14, 15, 16, 17, 18, 19, 21, 22, 24, 27, 30, 32
	4251	125, 250 mm
	477110G	4791
	457212	

**7511MR** 1/4"+1/2" €234 <sup>B</sup> 110 PC.

422 x 275 x 85 mm

Contents 6.9

	2335M	4, 4.5, 5, 5.5, 6, 7, 8, 9, 10, 11, 12, 13, 14
	2235M	6, 7, 8, 9, 10, 11, 12, 13
	2375M	E4, E5, E6, E7, E8
	4235M	14, 15, 17, 19, 22
	4335M	10, 11, 12, 13, 14, 15, 16, 17, 18, 19, 20, 21, 22, 24, 27, 30, 32
	4375M	E10, E12, E14, E16, E18, E20, E22, E24
	4635	16, 20, 8
	2031	PH1, PH2
	2032	4, 5.5, 6.5
	2033	T8, T10, T15, T20, T25, T27, T30
	2035	H3, H4, H5, H6
	1836P	PH3, PH4
	1836S	8x1.2, 10x1.6, 12x2.0
	1836T	T40, T45, T50, T55, T60
	1836H	H7, H8, H10, H12, H14
	1836Z	PZ3, PZ4
	1125M	1.5, 2, 2.5
	2745	277155G
	2178DF	2792
	477110G	4791
	222102, 222104	425105
	4222	3824
	770225	414810S

**4321MRE** 1/2" €127 <sup>B</sup> 21 PC.

Case 820003K (389 x 230 x 66 mm)  
EVA #8 (375 x 187 mm)

Contents 4.5

	4335M	10, 11, 12, 13, 14, 15, 16, 17, 18, 19, 21, 22, 24, 27, 30, 32
	477910B	412111G
	458312	425110
	4791	

**6318MR10** 3/4" €286 <sup>B</sup> 17 PC.

Contents 10.8

	6335M	22, 24, 27, 29, 30, 32, 33, 35, 36, 38, 41, 46, 50
	6251	100, 200
	677920F	657220



# IMPACT SOCKETS

CHROME MOLYBDENUM

At least 50% above the DIN and ANSI standards

LIFETIME GUARANTEE

METRIC SIZE

IMPERIAL SIZE



**4866P** 1/2" → 3/4" €11 B

**MULTIPLIER ADAPTER**

Input 1/2". For use with 3/4" impact socket.



**6864P** 3/4" → 1/2" €17 B

**REDUCER ADAPTER**

Input 3/4". For use with 1/2" impact socket. Max torque : 512 Nm.



**8866P** 1" → 3/4" €18 B

**REDUCER ADAPTER**

Input 1". For use with 3/4" impact socket. Max torque : 1412 Nm.



**4408MP** 1/2" €38 B

Contents 4535M 10, 12, 13, 14, 17, 19, 21, 24



**4414MP** 1/2" €59 B

Contents 4535M 10, 11, 12, 13, 14, 15, 16, 17, 18, 19, 21, 22, 24, 27



**4414SP** 1/2" €63 B

Contents 4535S 3/8", 7/16", 1/2", 9/16", 5/8", 11/16", 3/4", 13/16", 7/8", 15/16", 1", 1-1/16", 1-1/8", 1-1/4"



**4427MP** 1/2" €159 B

Contents 4535M 8, 9, 10, 11, 12, 13, 14, 15, 16, 17, 18, 19, 20, 21, 22, 23, 24, 25, 26, 27, 28, 29, 30, 32, 33, 34, 36



**4410MP** 1/2" €59 B

Contents 4435M 12, 13, 14, 17, 19, 21, 22, 23



**4418MP** 1/2" €98 B

Contents 4055 5, 6, 8, 10, 12, 14, 17, 19



**4457MP** 1/2" €107 B

Contents 4065 H4, H5, H6, H8, H10, H12, H14



**6414MP** 3/4" €288 B

Contents 6435M 19, 21, 22, 24, 26, 27, 29, 30, 32, 33, 35, 36, 38, 41



**6408MP10** 3/4" €98 B

Contents 6515M 19, 22, 24, 27, 30  
6535M 32, 36, 38



**883532M** 32 mm 1" €24 B

**883533M** 33 mm 1" €24 B

**6 POINTS METRIC THIN WALL LONG IMPACT SOCKET**

# ALLOY WHEELS SOCKETS



**44904MP** 1/2" €54 B

Contents	Ø	L mm
494515M	15	85
9BW4501	17	85.5
9BW4502	21	85.5
494522M	22	85



**44905MP** 1/2" €27 B

Contents	Ø	L mm
494517M	17	86
494519M	19	86
494521M	21	86

# PNEUMATIC IMPACT WRENCHES

2 YEAR GUARANTEE

**678 Nm** 109 mm **Mini**

1 2 3 speed regulator  
Forward / Reverse  
JUMBO HAMMER

**133431050** €199 B

**1288 Nm**

Forward / Reverse  
NEW TWIN HAMMER

**133481095** €308 B

**1491 Nm**

Forward / Reverse  
NEW TWIN HAMMER

**133681100** €369 B

**1356 Nm** 15 PC.

**144803AMP01** €299 B

Contents 4535M 17, 18, 19, 21, 22, 24, 27  
4435M 17, 19, 21  
33461100 (1356 Nm) SY251M (1/4" BSPT)  
426005P 4799P LUBE15

**2712 Nm**

TWIN HAMMER

**133861200** €1' €909 B  
**133862200** €1' €917 B

	Square drive	Anvil	Bolt size	Free speed	Max torque	Total length	Air Inlet	Air hose	Air pressure	Air consumption	Noise	Vibrations	Weight
	Inch	Std. / Long	mm	R.P.M	Nm	mm	Inch	ID	bar	L/min	DBA	M/S <sup>2</sup>	kg
<b>133431050</b>	1/2"	Std.	M16	9000	678	109	1/4"	3/8"	6.2	142	101.02	8.70	1.35
<b>133481095</b>	1/2"	Std.	M24	8000	1288	197	1/4"	3/8"	6.2	190	96	8.10	2.25
<b>133681100</b>	1/2"	Std.	M24	9500	1356	190	1/4"	3/8"	6.2	207	99.2	13.32	2.4
<b>133861200</b>	3/4"	Std.	M30	8000	1491	211	1/4"	3/8"	6.2	190	96	8.98	2.35
<b>133862200</b>	1"	Std.	M36	5000	2712	347	1/2"	3/4"	6.2	255	106	17.20	7.40
<b>133862200</b>	1"	Long	M36	5000	2712	487	1/2"	3/4"	6.2	255	104	14.5	8.10



COMBINATION WRENCHES

CHROME VANADIUM

At least 30% above the DIN and ANSI standards

LIFETIME GUARANTEE

WITHOUT RATCHET

**1062 I-beam**

I-beam profile

15°

13°

**New**

**12D06MRS01 €31**

Contents: 1062 10, 12, 13, 14, 17, 19 mm (0.82)

**12D21MRN €164**

Contents: 1062 6, 7, 8, 9, 10, 11, 12, 13, 14, 15, 16, 17, 18, 19, 20, 21, 22, 24, 27, 30, 32 mm (4.1)

**12D09MRN €43.20**

Contents: 1062 8, 9, 10, 11, 12, 13, 14, 17, 19 mm (0.80)

**12D15MRN01 €86**

Contents: 1062 8, 10, 11, 12, 13, 14, 15, 16, 17, 18, 19, 21, 22, 24 mm (1.96)

**12D15MRN €121**

Contents: 1062 10, 11, 12, 13, 14, 15, 16, 17, 19, 21, 22, 24, 27, 30, 32 mm (3.32)

**12D26MRN €209**

Contents: 1062 6, 7, 8, 9, 10, 11, 12, 13, 14, 15, 16, 17, 18, 19, 20, 21, 22, 23, 24, 25, 26, 27, 28, 29, 30, 32 mm (5.6)

**12A3MRN €99**

Contents: 1061 8, 10, 11, 12, 13, 14, 15, 16, 17, 18, 19, 22, 24 mm (2.16)

**1296MRN €219**

Heavy duty range. Contents: 1071 34, 36, 38, 41, 46, 50 mm (8.4)

**1214SRN01 €118**

Contents: 5060 3/8", 7/16", 1/2", 9/16", 5/8", 11/16", 3/4", 13/16", 7/8", 15/16", 1", 1-1/16", 1-1/8", 1-1/4" (3.54)

**1275MRN €130**

Contents: 1067 6, 7, 8, 10, 11, 12, 13, 14, 17, 19, 22, 24, 27, 30, 32 mm (3.18)

WITH NON-REVERSIBLE RATCHET

**12112MRS02 €169**

Non-reversible ratchet. Contents: 3731M 8, 10, 11, 12, 13, 14, 15, 16, 17, 18, 19, 22 mm (0.91)

**12107MRN01 €89**

Non-reversible ratchet. Contents: 3731M 8, 10, 11, 12, 13, 17, 19 mm (0.91)

**New**

**12007MRN €113**

Flexible head. Non-reversible ratchet. Contents: 3730M 8, 10, 12, 13, 14, 17, 19 mm (0.93)

**13013MRE €189**

Flexible head. Non-reversible ratchet. Contents: 3730M 8, 10, 12, 13, 14, 16, 17, 18, 19 mm (1.7)

**13316MR €128**

Short wrench version. Flexible head. Non-reversible ratchet. Contents: 3733M 8, 9, 10, 11, 12, 13, 14, 15, 16, 17, 18, 19 mm (1.7)

WITH REVERSIBLE RATCHET

**12210SR €149**

Reversible. Contents: 3732S 1/4", 5/16", 3/8", 7/16", 1/2", 9/16", 11/16", 3/4", 13/16", 7/8", 15/16" (1.8)

**New**

**373AM Anti-slip ring**

With its anti-slip ring, it will not slip off the fastener head.

You'll work faster, and increase productivity and safety.

**122A07MRN01 €119**

Reversible. Contents: 373AM 8, 10, 11, 12, 13, 17, 19 mm (0.91)

**122A12MRN €228**

Reversible. Contents: 373AM 8, 9, 10, 11, 12, 13, 14, 15, 17, 19, 22, 24 (2.06)

**122A14MRN €269**

Reversible. Contents: 373AM 8, 9, 10, 11, 12, 13, 14, 15, 16, 17, 18, 19, 22, 24 mm (2.50)

**14902MR €53**

2 sizes in 1. Reversible. Contents: 3739M 8 x 10 x 12 x 13 mm, 16 x 17 x 18 x 19 mm (0.37)

**14903MR €79**

Reversible. Contents: 3739M 8 x 9 x 10 x 11 mm, 12 x 13 x 14 x 15 mm, 16 x 17 x 18 x 19 mm (0.51)



WRENCH

CHROME VANADIUM

At least 30% above the DIN and ANSI standards

LIFETIME GUARANTEE



75° OFFSET RING WRENCH SET

1708MR €63 B

Contents 1.43  
1970 6 x 7, 8 x 9, 10 x 11, 12 x 13, 14 x 15, 16 x 17, 18 x 19, 21 x 23 8 PC.

1712MRN €128 B

Contents 3.32  
1970 6 x 7, 8 x 9, 10 x 11, 12 x 13, 14 x 15, 16 x 17, 18 x 19, 20 x 22, 21 x 23, 24 x 26, 25 x 28, 30 x 32 12 PC.



OPEN END WRENCH SET

1108MR €39 B

Contents 0.91  
1900 6 x 7, 8 x 9, 10 x 11, 12 x 13, 14 x 15, 16 x 17, 18 x 19, 20 x 22 mm 8 PC.

1112MRN €92 B

Contents 2.35  
1900 6 x 7, 8 x 9, 10 x 11, 12 x 13, 14 x 15, 16 x 17, 18 x 19, 20 x 22, 21 x 23, 24 x 27, 25 x 28, 30 x 32 mm 12 PC.



1306MRN €59 B

Contents 0.95  
1930 6 x 10, 10 x 12, 11 x 13, 12 x 14, 17 x 19, 19 x 22 6 PC.



1A06MR €79 B

Contents 1.32  
1910 8 x 9, 10 x 11, 12 x 13, 14 x 15, 16 x 17, 18 x 19 6 PC.



ANGLED SOCKET WRENCH SET

1912MR1 €115 B

Contents 4.75  
1081 8, 10, 11, 12, 13, 14, 16, 17, 18, 19, 22, 24 12 PC.

1812MR €112 B

Contents 4.75  
1080 8, 10, 11, 12, 13, 14, 16, 17, 18, 19, 22, 24 12 PC.

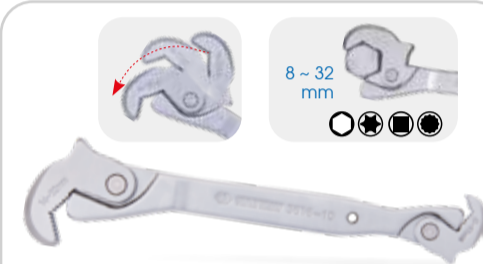

361610 €39 B

SELF-LOCKING SPEED WRENCH

Self-locking function grip. Ideal for : 6 points, XZN®, square, Torx®, and even damaged screw heads. Capacity: 8-32 mm. Length: 265 mm. Weight: 466 g.



Self-locking speed wrench

Versatile, it adapts to all shapes of bolts and pipes. Non-slip teeth, effective on worn screws. Solid and durable: made of chrome-molybdenum (CrMo).

3616S08P	12 ~ 28	350	€47 B
3616S14P	20 ~ 48	850	€67 B



Easy to use: one hand is enough.

Fast: thanks to the ratchet effect.

Effective: jaw design providing extra strong 3-point grip.



SINGLE OPEN END WRENCH

Features: The open end is thicker for very high tightening torques. Chrome vanadium alloy steel. Finished with phosphate sunk. DIN 894.

Size mm	L mm	g	€
10F017P	17	178 107	€4.20 B
10F019P	19	178 107	€5.20 B
10F021P	21	203 161	€6 B
10F022P	22	203 161	€6 B
10F023P	23	220 203	€8.20 B
10F024P	24	220 203	€8.20 B
10F026P	26	240 290	€9.60 B
10F027P	27	240 290	€9.60 B
10F029P	29	267 341	€11.50 B
10F030P	30	272 335	€12 B
10F032P	32	285 410	€14 B
10F036P	36	317 556	€19 B
10F038P	38	320 740	€20 B
10F041P	41	340 875	€23 B
10F046P	46	395 1060	€30 B
10F050P	50	425 1402	€37 B
10F055P	55	425 1403	€42 B
10F060P	60	470 2544	€57 B
10F065P	65	470 2441	€65 B
10F070P	70	500 3457	€82 B
10F075P	75	500 3333	€89 B



ADJUSTABLE WRENCHES

Millimetre graduation on the head. Chrome plated finish.

H1 mm	L mm	g	€
361106R	20 7 150 125	€10.70 B	
361108R	25 8 200 226	€12.70 B	
361110R	30 11 250 430	€16.60 B	
361112R	35 13 300 680	€21.30 B	
361115HR	43 13 375 1485	€45 B	
361118HR	52 18 450 1750	€76 B	
361124HR	62 23 600 3343	€147 B	



ADJUSTABLE WRENCHES WITH LATERAL NUT

No risk of jaws opening during use. Chrome plated finish.

H1 mm	L mm	g	€
362210R	32.8 8.3 258.5 483	€36 B	
362212R	38.1 9.6 308.5 786	€45 B	
362216R	50 12.8 406.5 1677	€59 B	
362220R	62 14.2 505.5 2634	€108 B	



361408R 2 IN 1 €38 B

REVERSIBLE JAW ADJUSTABLE WRENCH  
Dual function wide jaws that can be used as an adjustable wrench or pipe Wrench. Screw pin with front side metric or SAE scale 15°, flexible gear. High depth capacity, thanks to its 30% longer jaws than traditional adjustable wrenches. Super wide jaw opening, 50% wider than regular adjustable wrenches. TPR handle with end hole.



4506MR01 1/2" €50 B

WHEEL NUT WRENCH SET WITH HANDLE AND 1/2" SOCKETS

Removable and ergonomic 1/2" handle. Quick use of the handle with the removable bar. Allows deep access.

Contents	g
265 mm	1.56
300 mm	
17, 19, 21, 23 mm	

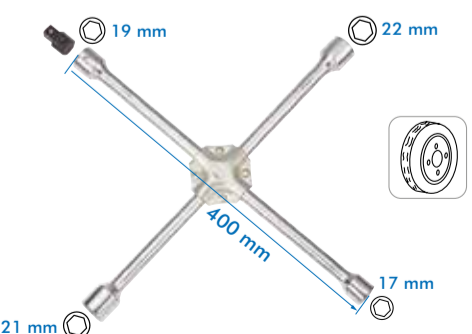

19911722 €29 B

1/2" WHEEL NUT WRENCHES

For dismantling wheels. Chrome plated finish.

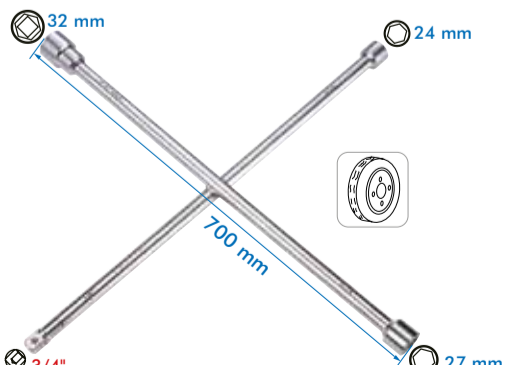

19932427 €72 B

3/4" WHEEL NUT WRENCHES

For dismantling wheels. Chrome plated finish.





PLIERS

LIFETIME GUARANTEE



GROOVE JOINT PLIERS

DIN ISO 8976.

	L mm	A mm	B mm	Number of positions	kg	
65117C	425	58	55	100	7	1150 €43 B



LOCKABLE TWIN GROOVE JOINT PLIERS

DIN ISO 8976. Serrated jaws lock on to pipes. Perfect grip on nuts.

	L mm	A mm	B mm	Number of positions	kg	
651708C	200	54	44	40	16	190 €28 B
651710C	250	68	56	60	22	360 €31 B
651712C	310	89	73	70	26	540 €37 B



PLIERS WRENCH

Smooth jaws to assemble plated fittings without damaging them. Suitable for gripping, holding, pressing and bending workpieces. Strong gripping power with 8x manual force transmission.



Ratchet function allowing to tighten or release bolts quickly and easily.

	L mm	A mm	B mm	Number of positions	kg	
651810C	266	35.5	57	42	17	509 €47 B



42124GP04

€88 B

Contents	kg
623208	1.5
611108	
631108	
651710C	



BOLT CUTTERS GS and TUV compliant.

L mm	Cutting Capacities Ø mm		kg		
	HRC 15	HRC 35			
613112	300	5	4	0.76	€31 B
613114	350	7	5	1	€37 B
613118	450	8	6	1.51	€46 B
613124	600	10	8	2.35	€58 B
613130	750	13	10	3.75	€77 B
613136	900	16	11	5.50	€105 B
613142	1050	18	13	8.56	€135 B



613308

€47 B

COMPACT BOLT CUTTER

High frequency induction hardening. Grip material: PP + TPR. DIN ISO 5749.

L mm	Cutting Capacities (Ø mm)	kg
200	6.0 Soft wire	3.99
	5.0 Semi-soft wire	
	4.0 Hard wire	
	3.5 Plano wire	

6011R

Single-point lock grip pliers

Chrome molybdenum (CR-MO) steel handle. Polished chrome plated finish.

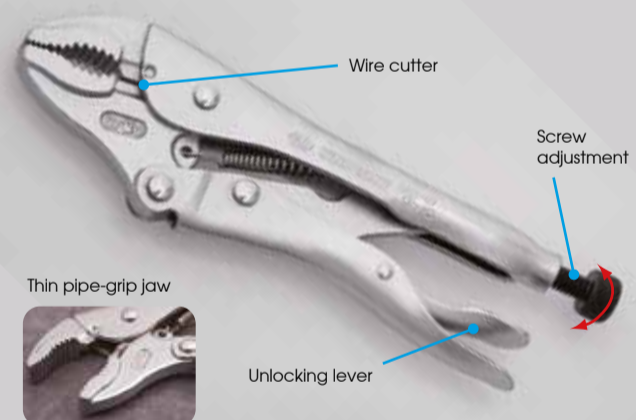

	L mm	mm	kg	
601107R	185	38	367	€16 B
601110R	254	48	542	€18 B

CIRCLIPS PLIERS



42154GP

€60 B

Contents	kg
66HS07 L 188 mm, Ø 19-60 mm	0.62
66HB07 L 175 mm, Ø 19-60 mm	
66SS07 L 188 mm, Ø 19-60 mm	
66SB07 L 175 mm, Ø 19-60 mm	



42116GP

€106 B

Contents	kg
68HS07 L 180 mm, Ø 18-60 mm ; 68HS10 L 250 mm, Ø 30-100 mm	1.33
68HB07 L 170 mm, Ø 18-60 mm	
68SS07 L 180 mm, Ø 18-60 mm ; 68SS10 L 250 mm, Ø 30-100 mm	
68SB07 L 170 mm, Ø 18-60 mm	



45211PP

€196 B

Interchangeable tips. Ratcheting locking action handles.

Contents	kg
L 406 mm, Ø 82-175 mm	3.32
45° Ø 82-175 mm	
90° Ø 82-175 mm	
L 406 mm, Ø 82-165 mm	
45° Ø 82-165 mm	
90° Ø 82-165 mm	



604209

€54 B

**LOCK GRIP PLIERS**  
620 daN max tightening. Length: 220 mm. Weight: 650 g. Jaw width: 16 mm. Easy clamping and release with a single hand. 4 positions. Chromed protection. Adjust clamping force with the wheel.

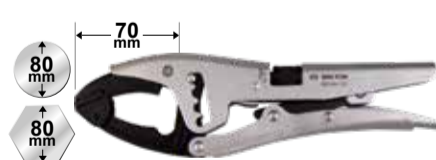

604410

€61 B

**LOCK GRIP PLIERS**  
320 daN max tightening. Length: 250 mm. Weight: 770 g. Jaw width: 16 mm. Easy clamping and release with a single hand. 4 positions. Chromed protection. Adjust clamping force with the wheel.



604511

€69 B

**LOCK GRIP PLIERS**  
290 daN max tightening. Length: 270 mm. Weight: 710 g. Jaw width: 16 mm. Easy clamping and release with a single hand. 4 positions. Chromed protection. Adjust clamping force with the wheel.



604310

€48 B

**LOCK GRIP PLIERS**  
310 daN max tightening. Length: 250 mm. Weight: 760 g. Jaw width: 16 mm. Easy clamping and release with a single hand. 4 positions. Chromed protection. Adjust clamping force with the wheel.

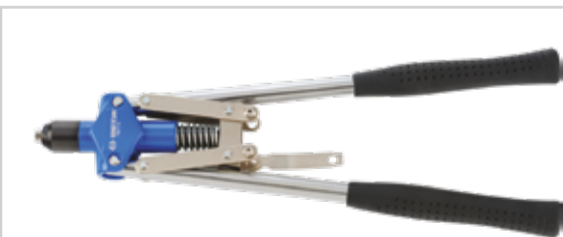

79711

€55 B

**2-ARM MANUAL RIVETING PLIERS**  
For Ø 3.2, 4, 4.8, 6.4 mm rivets. Cast aluminium body. Length: 460 mm. Weight: 1488 g.



213009MR

€69 B

**THREADED INSERT RIVET TOOL SET**  
Designed for fastening objects to thin metal. 4 interchangeable mandrels (M4, M5, M6, M8). Iron nut rivet selection 80 pcs. Length: 265 mm. Weight: 1320 g. Dimensions of the thermoformed: 186 x 375 mm.



79731

€87 B

**2 ARM RIVETING PLIERS**  
4 stainless steel riveting nozzles. For stainless steel or aluminum rivets: M5, M6, M8 and M10. Cast aluminium body. Length: 472 mm. Weight: 1.86 kg.



2120101

€23 B

**MANUAL RIVETING PLIERS**  
For rivets Ø 2.4, 3.2, 4, 4.8 mm. Cast aluminium body. 4 Nosepieces. Length: 260 mm. Weight: 539 g



SCREWDRIVERS, L-WRENCHES AND BITS

LIFETIME GUARANTEE

Screwdrivers



Hanging hole



Round shank



7 PC.

SNCM + V

**30117MR €29** B

Contents		Wt
⊕	1421 PH1x80, PH2x100	0.72
⊖	1422 3x75, 4x100, 5.5x125, 6.5x150, 8x175	



6 PC.

SNCM + V

**31116MR €24** B

Contents		Wt
⊕	1421 PH0x60, PH1x80, PH2x100	0.56
⊖	1422 3x75, 5.5x100, 6.5x150	



7 PC.

SNCM + V

**30317PR €30** B

Contents		Wt
⊕	1423 T10x75, T15x75, T20x100, T25x100, T27x100, T30x125, T40x150	0.78

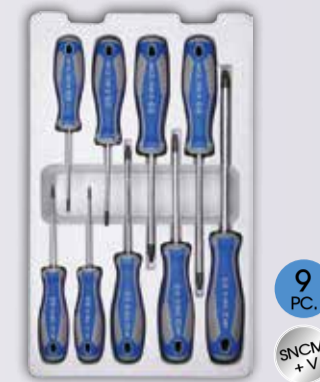

9 PC.

SNCM + V

**30319PR €36** B

Contents		Wt
⊕	1423 T8x75, T9x75, T10x75, T15x75, T20x100, T25x100, T27x100, T30x125, T40x150	0.88



Limited quantity

S2

**30106AMRB €18** B

Contents		Wt
⊕	14A1 PH1 x 80, PH2 x 100	0.56
⊖	14A2 3 x 75, 4 x 100, 5.5 x 152, 6.5 x 150	

Go thru screwdrivers



Go-through blade



Steel tipped handle for allowing light strikes



Hex-shank

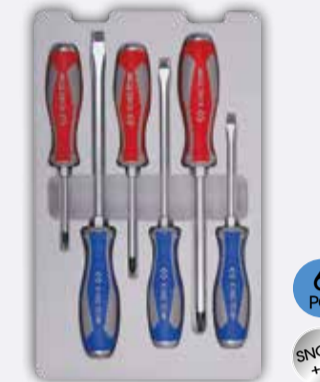

6 PC.

SNCM + V

**30206MR €44** B

Contents		Wt
⊕	1461 PH1x75, PH2x100, PH3x150	1.2
⊖	1462 5.5x100, 6.5x150, 8x175	

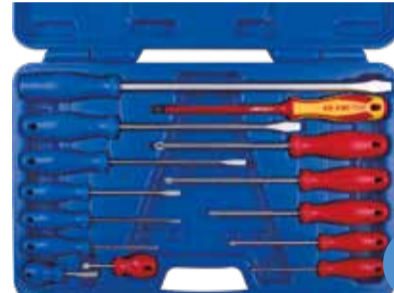

Cr-V

14 PC.

**35114MR €58.10** B

Contents		Wt
⊕	1411 PH0 x 75, PH1 x 100, PH2 x 100, PH2 x 150, PH2 x 38, PH3 x 150	2.4
⊖	1412 3x75, 4x100, 5.5x125, 6.5x150, 6.5 x 38, 8 x 200	
⊕	1472 6.5 x 1	
⊖	1482 10 x 300	



12 PC.

SNCM + V

**30112MR €89** B

Contents	
⊖	1450 4, 4.5, 5, 5.5, 6, 7, 8, 9, 10, 11, 12, 13



11 PC.

S2

**1011MQ €22** B

Contents		Wt
⊖	10 mm (L:36mm) 1636M M5, M6, M8, M10, M12	0.82
⊖	10 mm (L:80mm) 1680M M5, M6, M8, M10, M12	
⊖	1/2" 4148 10 mm	



23 PC.

S2

**1023EQ €47** B

Contents		Wt
⊖	10 mm (L:36 mm) 1636E 10IP, 15IP, 20IP, 25IP, 27IP, 30IP, 40IP, 45IP, 50IP, 55IP, 60IP	1.36
⊖	10 mm (L:80 mm) 1680E 10IP, 15IP, 20IP, 25IP, 27IP, 30IP, 40IP, 45IP, 50IP, 55IP, 60IP	
⊖	1/2" 4148 10 mm	

Rebellious screws and bolts? Think of the impact screwdriver!

Impact screwdriver



The impact force releases rusted or frozen screws without damaging them. Handle with 2 non-slip knurled areas for a solid and secure grip. Practical, it can be used anywhere, since no external power source is required.



2 PC.

**4116FR01 1/2" + 3/4" €57** B

IMPACT SCREWDRIVER SET

Maximum torque of the 1/2" sockets adapter: 512 Nm. Handle with tightening / loosening functions.

Contents		Wt
⊖	4116 (3/4")	1.27
⊖	6814 (3/4" → 1/2")	



10 PC.

**4505MR 1/2" 5/16" €49** B

IMPACT SCREWDRIVER SET

Contents		Wt
⊕	5/16" 1836P PH2, PH3	1.6
⊖	5/16" 1836S 9, 11	
⊖	1/2" 4335M 8, 10, 12, 14	
⊖	4112 (1/2")	
⊖	4148 (1/2" → 5/16")	



3 PC.

SNCM + V

**31003MR €20** B

Contents		Wt
⊕	1421 Extra-long PH2 x 300	0.384
⊖	1422 Extra-long 6.5 x 300	
⊖	212118	



233 x 120 x 43 mm

**32518MR €39** B

Longueur des lames : 125 mm.

Contents		Wt
⊕	1317PN PH1 x PH2	0.7
⊖	1317SN 4 x 6, 5 x 7	SNCM + V
⊕	1317ZN P21 x P22	
⊕	1317TN T10 x T15, T20 x T25, T30 x T40	
⊕	1317BHN H4 x H4, H5 x H5, H6 x H6	
⊖	91232	



9 PC.

**32809MR 1/4" €26** B

ARTICULATED RATCHET SCREWDRIVER SET WITH BITS

Contents		Wt
⊖	1/4" 1025S 4, 5	0.3
⊕	1/4" 1025P PH1, PH2, PH3	
⊕	1/4" 1025Z PZ1, PZ2	
⊖	75060	
⊖	2166DF	



55 PC.

**2555MR 1/4" €67** B

Articulated handle, ideal for confined and difficult to reach spaces

Contents		Wt
⊖	1/2" 2335M 4, 4.5, 5, 5.5, 6, 7, 8, 9, 10, 11, 12, 13, 14	1
⊖	1/4" 1025S 3, 4, 4.5, 5, 5.5, 6, 6.5, 8	
⊕	1/4" 1025P PH0, PH1, PH2, PH3	
⊕	1/4" 1025Z P20, PZ1, PZ2, PZ3	
⊕	1/4" 1025U T10H, T15H, T20H, T25H, T27H, T30H, T40H	
⊕	1/4" 1025H H2, H2.5, H3, H4, H5, H6, H8	
⊕	1/4" 1025T T10, T15, T20, T25, T27, T30, T40	
⊕	1/4" 1025R RB1, RB2	
⊖	770225	
⊖	75060	
⊖	2166DF	



43 PC.

S2

**1043CQ 10 mm €71** B

Impact version.

Contents		Wt
⊖	10 mm (L:36mm) 1636H H4, H5, H6, H7, H8, H10, H12	2.42
⊖	10 mm (L:80mm) 1680H H4, H5, H6, H7, H8, H10, H12	
⊖	10 mm (L:36mm) 1636M M5, M6, M8, M10, M12	
⊖	10 mm (L:80mm) 1680M M5, M6, M8, M10, M12	
⊕	10 mm (L:36mm) 1636T T20, T25, T27, T30, T40, T45, T50, T55, T60	
⊕	10 mm (L:80mm) 1680T T20, T25, T27, T30, T40, T45, T50, T55, T60	
⊖	1/2" 4147 10 mm	



SCREWDRIVERS, L-WRENCHES AND BITS

LIFETIME GUARANTEE

**ATOM Series**

140 x 65 x 36 mm

26 PC.

1026CQAM

Contents

- 1/4" 1025H H3, H4, H5, H6, H8
- 1/4" 1025T T10, T15, T20, T25, T27, T30, T40
- 1/4" 1025Z PZ1, PZ2, PZ3
- 1/4" 1025P PH1, PH2, PH3
- 1/4" 1025U T10H, T15H, T20H, T25H, T30H
- 276B35
- 75363
- 770225

120 x 70 x 42 mm

32 PC.

1032CQ

Contents

- 1/4" 1025S 3, 4, 5, 6 mm
- 1/4" 1025P PH1, PH2, PH2, PH3
- 1/4" 1025Z PZ1, PZ2, PZ2, PZ3
- 1/4" 1025T T10, T15, T20, T25, T27, T30, T40
- 1/4" 1025U T10H, T15H, T20H, T25H, T27H, T30H, T40H
- 1/4" 1025H H3, H4, H5, H6
- 75363
- 770225

150 x 102 x 46 mm

49 PC.

1048MR

Contents

- 1/4" 1025S 3 x 0.5, 4 x 0.5, 5 x 0.8, 6 x 1
- 1/4" 1025P PH1 x 2, PH2 x 2 ø6mm, PH3, PH2 ø4.7mm
- 1/4" 1025T T10, T15, T20 x 2, T25, T27, T30, T40
- 1/4" 1025H H3, H4, H5, H6
- 1/4" 1025U T10H, T15H, T20H x 2, T25H, T27H, T30H, T40H
- 1/4" 1025Z PZ2 x 2
- 1/4" 7150T T15, T20, T25
- 1/4" 7150S 4.0 x 0.8, 6.0 x 1.0
- 1/4" 7150H H3, H4, H5, H6, H7, H8
- 1/4" 7150P PH2 x 2
- 1/4" 7150Z PZ2
- 75075
- 75363
- 2746

150 x 102 x 46 mm

49 PC.

1049CQ10

Contents

- 1/4" 1025P PH1 x 2, PH2 x 2 ø6mm, PH2 x 2 ø4.7mm, PH3 x 2
- 1/4" 1025S 4.0 x 2, 5.5 x 2, 6.5 x 2
- 1/4" 1025Z PZ1 x 2, PZ2 x 2, PZ3 x 2
- 1/4" 1025T T9, T10, T15, T20, T25, T27, T30, T40
- 1/4" 1025H H2, H2.5, H3, H4, H5, H6, H7, H8
- 1/4" 1025U T9H, T10H, T15H, T20H, T25H, T30H, T40H
- 1/4" 1025R RB1, RB2
- 1/4" 2142 2142
- 1/4" 770 770225
- 1/4" 750A 75050A

140 x 65 x 36 mm

26 PC.

1026CQAM

Contents

- 1/4" 1025H H3, H4, H5, H6, H8
- 1/4" 1025T T10, T15, T20, T25, T27, T30, T40
- 1/4" 1025Z PZ1, PZ2, PZ3
- 1/4" 1025P PH1, PH2, PH3
- 1/4" 1025U T10H, T15H, T20H, T25H, T30H
- 276B35
- 75363
- 770225

120 x 70 x 42 mm

32 PC.

1032CQ

Contents

- 1/4" 1025S 3, 4, 5, 6 mm
- 1/4" 1025P PH1, PH2, PH2, PH3
- 1/4" 1025Z PZ1, PZ2, PZ2, PZ3
- 1/4" 1025T T10, T15, T20, T25, T27, T30, T40
- 1/4" 1025U T10H, T15H, T20H, T25H, T27H, T30H, T40H
- 1/4" 1025H H3, H4, H5, H6
- 75363
- 770225

150 x 102 x 46 mm

49 PC.

1048MR

Contents

- 1/4" 1025S 3 x 0.5, 4 x 0.5, 5 x 0.8, 6 x 1
- 1/4" 1025P PH1 x 2, PH2 x 2 ø6mm, PH3, PH2 ø4.7mm
- 1/4" 1025T T10, T15, T20 x 2, T25, T27, T30, T40
- 1/4" 1025H H3, H4, H5, H6
- 1/4" 1025U T10H, T15H, T20H x 2, T25H, T27H, T30H, T40H
- 1/4" 1025Z PZ2 x 2
- 1/4" 7150T T15, T20, T25
- 1/4" 7150S 4.0 x 0.8, 6.0 x 1.0
- 1/4" 7150H H3, H4, H5, H6, H7, H8
- 1/4" 7150P PH2 x 2
- 1/4" 7150Z PZ2
- 75075
- 75363
- 2746

150 x 102 x 46 mm

49 PC.

1049CQ10

Contents

- 1/4" 1025P PH1 x 2, PH2 x 2 ø6mm, PH2 x 2 ø4.7mm, PH3 x 2
- 1/4" 1025S 4.0 x 2, 5.5 x 2, 6.5 x 2
- 1/4" 1025Z PZ1 x 2, PZ2 x 2, PZ3 x 2
- 1/4" 1025T T9, T10, T15, T20, T25, T27, T30, T40
- 1/4" 1025H H2, H2.5, H3, H4, H5, H6, H7, H8
- 1/4" 1025U T9H, T10H, T15H, T20H, T25H, T30H, T40H
- 1/4" 1025R RB1, RB2
- 1/4" 2142 2142
- 1/4" 770 770225
- 1/4" 750A 75050A

**New**

8 PC.

124308PR

Contents

- T5, T6, T7, T8, T9, T10, T15, T20

FREE BLUE RING

8 PC.

23208MR

Contents

- H2, H2.5, H3, H4, H5, H6, H8, H10

8 PC.

22218MR

Contents

- H2, H2.5, H3, H4, H5, H6, H8, H10

9 PC.

22319TR

Contents

- T10, T15, T20, T25, T27, T30, T40, T45, T50

3 PC.

9103PR

SOCKET HOLDER SET WITH SAFETY BALL - 3 PCS

Ideal for screwguns.

Contents

- 1/4" 50 mm
- 3/8" 50 mm
- 1/2" 50 mm

10 PC.

20210MR

Contents

- H3, H4, H5, H6, H7, H8, H10, H12, H14, H17

8 PC.

20108MR

Contents

- H2, H2.5, H3, H4, H5, H6, H8, H10

9 PC.

20109MR

Contents

- H1.5, H2, H2.5, H3, H4, H5, H6, H8, H10

9 PC.

201B09MR

Contents

- H1.5, H2, H2.5, H3, H4, H5, H6, H8, H10

9 PC.

20319PR

Contents

- T10, T15, T20, T25, T27, T30, T40, T45, T50

9 PC.

20419PR

Contents

- T10H, T15H, T20H, T25H, T27H, T30H, T40H, T45H, T50H

9 PC.

20109MW

Contents

- H1.5, H2, H2.5, H3, H4, H5, H6, H8, H10

9 PC.

20110MR

Contents

- H1.5, H2, H2.5, H3, H4, H5, H6, H8, H10

9 PC.

20129SR

Contents

- 1/16", 3/32", 1/8", 5/32", 3/16", 1/4", 5/16", 3/8", 5/64"

9 PC.

204B29PR

Contents

- T10, T15, T20, T25, T27, T30, T40, T45, T50

MATERIALS

DURABILITY

- Cr-V chrome vanadium steel alloy
- S2 silicon chrome vanadium steel alloy
- SNCM+V nickel chromium molybdenum vanadium silicon steel alloy

PIPE TOOLS

LIFETIME GUARANTEE



6531

STILLSON TYPE PIPE WRENCHES

Forged monobloc body and jaws. HRC 57 hardened serrated edge.

	max mm	mm	inch	g	€
653118	60	407	18	1720	€35
653124	75	539	24	3150	€54
653136	102	825	36	6280	€112
653148	140	1034	48	9750	€162



6541L Aluminum

ALUMINUM OFFSET PIPE WRENCH 90°

Suitable for walls and floors, ceilings and other places beside the pipe work. Aluminum body. 90° offset.

	max mm	mm	inch	g	€
654114L	60	356	14"	856	€41
654118L	76	457	18"	1486	€65

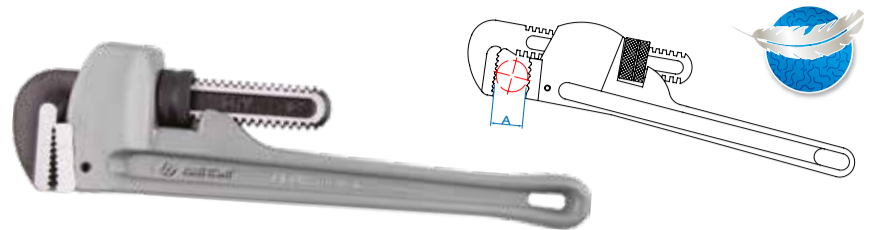

6533L Aluminum

ALUMINUM PIPE WRENCH

40% lighter than the heavy-duty models. Easy spin adjusting nut. Heat-treated drop-forged jaws.

	L inch	L mm	g	€	
653310L	30	10	254	540	€24
653312L	40	12	300	833	€31
653314L	50	14	356	600	€35
653318L	60	18	455	1500	€55
653324L	75	24	600	2500	€82
653336L	85	36	910	5000	€162
653348L	110	48	1200	8000	€318



791221



791222

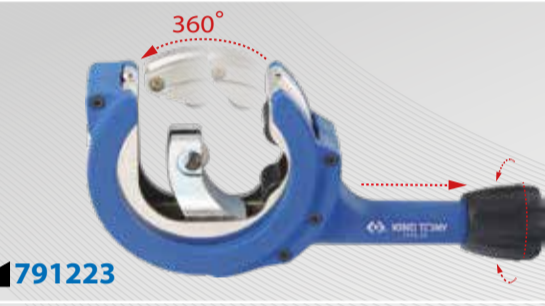

791223

PIPE CUTTER RATCHET

Cuts without having to rotate the tool around the tube. Ideal for reduced spaces. Cut more resistant steel: stainless steel, copper and aluminum. Without reamer.

	Capacity ø mm	Max. cutting thickness (mm)		g	€
		Stainless	Other		
791221	8 ~ 28	2	3.0	389	€50
791222	12 ~ 35	2	3.0	452	€58
791223	28 ~ 67	2	3.0	1122.6	€136



7HA03

1/2"

€40

3 PC.

STAGED MOUNTING WRENCH

Designed to install and remove most of radiator valves and tank connectors. The 3/8", 11.6mm, 1/2", 3/4" and 1" hexagons built on the wrench's length allow to install different sizes of solenoid valves internal and external pods. The 472411G can be used as a traditional ratchet with the accessory 472401. The 1/2" ratchet makes the installation quick and easy.

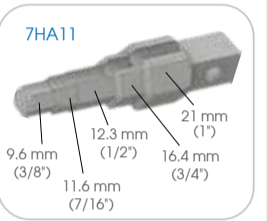

7HA21

€12

4 WAY CONTROL CABINET KEY

For control cabinets and shut-off systems in the supply of gas, water and electricity. For technical installations in buildings, e.g. air conditioning and ventilation systems, shut-off valves, mains switch-boards, etc.

TOOLS FOR ELECTONICS AND ELECTRICITY

Self-Retracting Blade Safety Cutter

2 in 1: choose between the auto-retracting function (1) or locking the blade manually (2).



60 x 18 mm trapezoidal blade, made of SK5 carbon steel  
Blade tank (2 blades included)



794607

€14

Thread cutting notch

Non-slip TPR

Compatible with blades 794507P01

794507

€13

DOUBLE BLADE FOLDABLE BOX CUTTER

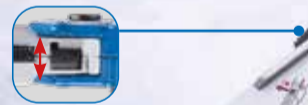

Sélection de la lame



trapezoidal blade

hook blade

171 mm



With belt clip



797707

€6.30

UTILITY CUTTER

Improved blade locking system. Blade material: SK4, HRC ≥ 65. Blade treatment: laser hardening technique ensuring great hardness of the cutting edge. Blade with black coating. Blade thickness: 0.7 mm. Length: 180 mm.

180 mm



117

797807P02

€3.20

SNAP-OFF BLADES

Blade width: 18 mm. Blade material: SK4. For 797707 and 797807.

10 PC.

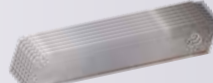

797807

€4.90

BOX CUTTER WITH AUTOMATIC BLADE LOADER

Automatically reloading snap-off blades. Blade material: SK4, HRC ≥ 62. Blade thickness: 0.5 mm. Blade width: 18 mm.

175 mm



3-blade cartridge.

132



Release buckle



Blade fixator folded out



With belt clip

794108A

€22

SAFETY CLASP KNIFE

Light and handy to use. Stainless Blade with blacking coating.

210 mm

90 mm 120 mm



173



TOOLS FOR ELECTRONICS AND ELECTRICITY

**6AB3395** €22 B

**MULTIPURPOSE SCISSORS**  
Scissors designed for cutting soft materials such as tin foil, plastics, cardboard, paper, etc.

246 mm  
73 mm

Stainless steel 420J2 (HRC 52-55)

73mm non-slip micro-serrated blade

Iron and aluminum wire cutting notch

3 positions: closed, half-open, open

PP + TPR

The wide angle between the handle and the blades allows the user's hand to never touch the material when cutting.

Cutting capacities:  
 aluminum wire: 2.5mm  
 copper wire: 2.5mm  
 cardboard: 10mm  
 carpet: 5mm  
 copper: 0.5mm  
 soft aluminum: 0.6mm

312

**6AB1406** €25 B

**MULTIFUNCTION ELECTRICIAN SCISSORS**  
All steel structure, durable and very strong.

161 mm

Stainless steel 4034 (HRC 54-55)

24mm non-slip micro-serrated blade

Cable cutter on both blades up to 50mm<sup>2</sup> (AWG : 1/0)

50mm<sup>2</sup>

Crimping of insulated lugs and non-insulated lugs: 2.5mm<sup>2</sup> (AWG : 14)

2 stripping slots: 1.5 and 2.5mm (AWG : 12, 14)

PP + TPR

Sheath included

193

**6AB1465** €32 B

**MULTIFUNCTION ELECTRICIAN SCISSORS**  
All steel structure, durable and very strong.

170 mm

Stainless steel 4034 (HRC 54-55)

21mm non-slip micro-serrated blade

Cable cutter on both blades up to 80mm<sup>2</sup> (AWG : 3/0)

80mm<sup>2</sup>

Crimping of insulated lugs and non-insulated lugs: 2.5mm<sup>2</sup> (AWG : 14)

3 stripping slots: 1.5, 2.5 and 4mm (AWG : 16, 14, 12)

PP + TPR

Ergonomic

Sheath included

228

**6AB3175** €11 B

**MULTIPURPOSE SCISSORS**

Wire stripper from 1.5 to 4 mm<sup>2</sup> (AWG : 16-12)

Blade safety lock

185 mm  
52 mm

branches

cardboard cable rubber

copper 0.5mm aluminium 0.5mm leather 2mm

160

**6AB1255** €11 B

**ELECTRICIAN SCISSORS**

55mm non-slip micro-serrated blade

Wire stripper

145 mm  
55 mm

Stainless steel

PP + TPR

Cutting capacity  
 electric cable: 10mm  
 card: 10mm  
 rubber: 10mm  
 leather: 10mm  
 cold-rolled steel: 0.5mm  
 copper: 0.5mm  
 aluminum: 0.5mm

94

**6AB1306** €22 B

**ELECTRICIAN SCISSORS**  
High cutting performances with reduced effort.

150 mm  
26 mm

Stainless steel AUS-8 (59 HRC)

26mm non-slip micro-serrated blade

38mm<sup>2</sup>

Cable cutter on both blades up to 38mm<sup>2</sup> (AWG : 2)

114

**675144** €17 B

**MULTI-FUNCTION WIRE STRIPPER**

Pliers

Cable stripper

Cable stripper Ø 6 - 10 mm

Wire stripper 0.8 ~ 2.6 mm<sup>2</sup> 10 ~ 20 AWG

Wire cutter Ø 6 mm

Locking

116

**6CB41** 80~1000 V €56 B

**9 IN 1 MULTIFUNCTIONAL WIRE STRIPPER**

Approval: CAT IV 1000, EN 61010-1 : 2010/A1 : 2019, EN 62471 : 2008, EN 61326-1 : 2013, EN 61326-2-2 : 2013

AAA 1.5V x2 included

COB LED lighting

Magnetic

Locking

Non-contact voltage detection 80 - 1000V AC

Screwdriver PH2 x1 (65-70 mm)

Wire cutter Ø 7 mm

Romex® type NM-B cable stripper 12/2

Wire stripper 0.5 ~ 8 mm<sup>2</sup> 8 ~ 20 AWG

Stripping length adjustment

220

220 mm

7 PC.

**42107GX** €132 B

**RATCHETING CRIMPING PLIERS SET WITH INTERCHANGEABLE JAWS**  
Ratcheting system providing a complete and even crimping.

**6AG1120** €2 B

**PVC INSULATED TAPE**  
Length: 18 m  
Width: 18 mm

52

**67A107** €18 B

**WIRE STRIPPER**

Wire stripper 0.05 ~ 3.5 mm<sup>2</sup> 30 ~ 12 AWG

Wire cutter Ø 5 mm

209

**676208** €20 B

**WIRE STRIPPER**

Wire stripper 0.2 ~ 6.0 mm<sup>2</sup> 24 ~ 10 AWG

Wire cutter Ø 6 mm

Insulated terminal crimping 0.5 ~ 6 mm<sup>2</sup>, 22 ~ 10 AWG

271

**672110** €30 B

**STANDARD CRIMPING PLIERS FOR INSULATED CONNECTORS**

Wire cutter Ø 6 mm

Bolt-cutter M2.6 ~ M5

Insulated terminal Crimping 0.5 ~ 6 mm<sup>2</sup>

Wire stripper 0.75 ~ 6 mm<sup>2</sup> 10 ~ 22 AWG

Non-Insulated terminal Crimping 0.5 ~ 6 mm<sup>2</sup>

248

250 mm



TOOLS FOR ELECTRONICS AND ELECTRICITY

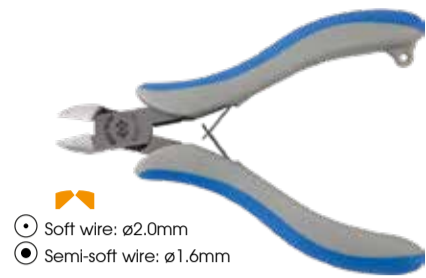

- Soft wire:  $\varnothing$ 2.0mm
- Semi-soft wire:  $\varnothing$ 1.6mm

620705 €12

DIAGONAL PRECISION CUTTING PLIERS

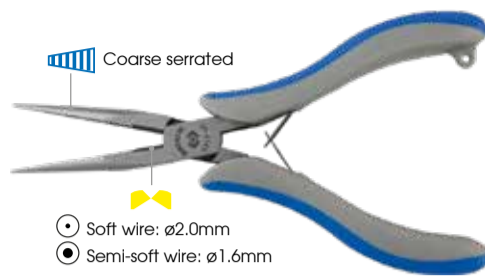

Coarse serrated

- Soft wire:  $\varnothing$ 2.0mm
- Semi-soft wire:  $\varnothing$ 1.6mm

631706 €13

PRECISION PLIERS WITH HALF-ROUND NOSE



634705 €12

SHORT ROUND NOSE PRECISION PLIERS



CE +12.0V -12.0V

9DC242 6~24V DC €44

DIGITAL DISPLAY CIRCUIT TESTER

For 6/12/24V DC circuits only. Checks if the circuit is electrified or not by stainless steel stylus. Powered from the power source being measured, no batteries required. 3 M long retractable cable. Bigger heavy duty insulated alligator ground clip. CE approval EN 61000-6-3(2007), EN 61000-6-1(2007) Do not use on air bags.

LCD display easy to read digital voltage display.

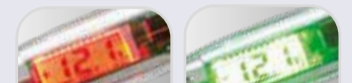

positive(+) negative(-)



8 PC.

32108MR €24

Contents		0.26
+	1431 PH000x40, PH00x40, PH0x40, PH1x40	
-	1432 1.5x40, 2.0x40, 2.5x40, 3.0x40	



9 PC.

32309PR €26

Contents		0.26
	1433 T4x40, T5x40, T6x40, T7x40, T8x40, T9x50, T10x50, T15x50, T20x50	

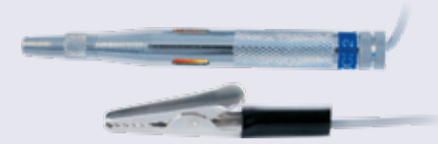

9DC22 6~24V DC €7

CIRCUIT TESTER

Test voltage 6 ~ 24V for use on D.C. circuits only. LED testing. Cover cap for contact needle. Interchangeable bulb (24V/3W), 90 cm cable. Bronze body housing.



9DC23 3~48V DC €10

VOLTAGE TESTER

Test voltage 3 ~ 48V for use on D.C. circuits only. Insulated alligator clip with 150 cm cable. 2 LED indicate positive(+) / negative(-) polarity. Weight: 52 g.

2 test positions:



9DM1371 €159

DIGITAL MULTIMETER

Save values, automatic range, automatic power-off selection. Indication of the unit and function. 600V protection.



TECHNICAL INFORMATION

DC voltage (0.1mV ~ 1V)	400mV / 4V / 40V / 400V / 600V
AC voltage (0.001V ~ 1V)	400mV / 4V / 40V / 400V / 600V
DC amps (0.1uA ~ 0.01A)	400uA / 4000uA / 40mA / 4000mA / 10A
AC Amps (0.1uA ~ 10A)	400uA / 4000uA / 40mA / 400mA / 10A
Resistance (0.1 $\Omega$ ~ 10k $\Omega$ )	400 $\Omega$ / 4k $\Omega$ / 40k $\Omega$ / 400k $\Omega$ / 4M $\Omega$ / 40M $\Omega$
Frequency (1Hz ~ 10kHz)	4 KHz / 40kHz / 400kHz / 4MHz / 40 MHz
Continuity test	yes Diode test yes
Low battery indicator	yes
Sampling rate	2 times per second
Overload indicator	OL
Dimension	150 x 70 x 35 mm Weight 300 g
Approval	CE IEC1010-1CAT II



9DM1361 €72

DIGITAL MULTIMETER

Automatic switch off. Automatic calibre selection. Negative polarity indicator (no indicator for positive polarity). Low energy consumption.

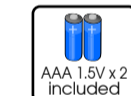

TECHNICAL INFORMATION

DC voltage (0.1mV ~ 600V)	200mV / 2V / 20V / 200V / 600V
AC voltage (0.001V ~ 600V)	2V / 20V / 200V / 600V
DC amps (0.1uA ~ 10A)	200uA / 2000uA / 20mA / 2A / 10A
AC Amps (0.1uA ~ 10A)	200uA / 2000uA / 20mA / 2A / 10A
Resistance (0.1 $\Omega$ ~ 20M $\Omega$ )	200 $\Omega$ / 2k $\Omega$ / 20k $\Omega$ / 200k $\Omega$ / 2M $\Omega$ / 20M $\Omega$
Continuity test	yes Continuity test yes
Low battery indicator	yes Hfe(NPN, PNP) yes
LCD display	3-1/2 digits 1999 points
Sampling rate	3 times per second
Dimension	138 x 70 x 32 mm Weight 85 g
Approval	CE EN61010-1, 600V CATII, 300V CATIII



6CB21 €65

DIGITAL VOLTAGE TESTER

Test high and low voltage quickly and safely in engines, cars, hydroelectric energy, etc. Self-Diagnostic test. Phase detection. Phase rotation test. LED light. LCD screen.



TECHNICAL INFORMATION

DC Voltage Test	12, 24, 50, 120, 230, 400, 690V
AC Voltage Test	12, 24, 50, 120, 230, 400, 690V
High voltage indication	$\geq$ 50V
Frequency range	0-70Hz
Continuity test	0-550k $\Omega$
Working temperature	-10-55°C
Dimension	255 x 66 x 30 mm Weight 250 g
Approval	EN 61243-3 / IEC 61243-3, EN 61010-1 / IEC 61010-1, CAT.III 690V / CAT.IV 600V



9DM2351 €134

AC CLAMP AMMETER

Overload indicator: "OL" and beep. Max clamp size:  $\varnothing$  30 mm. Negative polarity indicator (no indication for positive polarity). Auto switch off after 15 minutes. Low energy consumption. Removable test cables. Easy to use. Sold in a storage pouch.

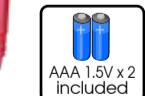

TECHNICAL INFORMATION

AC Amps (0.1A - 1A)	200A / 600A
AC voltage (0.001V - 1V)	2V / 20V / 200V / 600V
DC voltage (0.1mV - 1V)	200mV / 2V / 20V / 200V / 600V
Resistance (0.1 $\Omega$ - 0.01M $\Omega$ )	200 $\Omega$ / 2k $\Omega$ / 20k $\Omega$ / 200k $\Omega$ / 2M $\Omega$ / 20M $\Omega$
Continuity test	yes Diode test yes
Low battery indicator	yes
LCD display	3-1/2 digits 1999 points
Sampling rate	3 times per second
Dimension	117 x 76 x 18 mm Weight 121 g
Approval	CE IEC 61010-1, IEC 61010-2-032 CAT.III 600V Degré de pollution 2

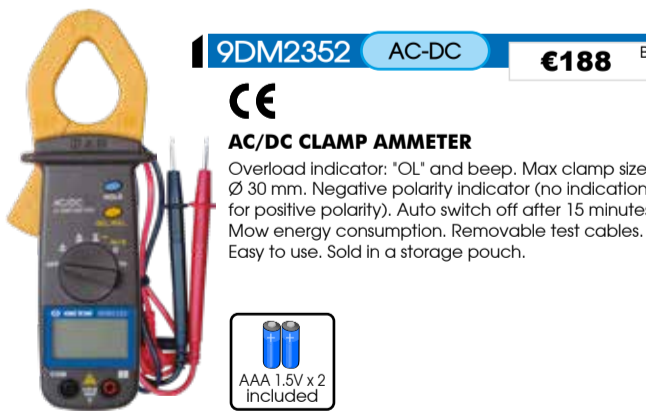

9DM2352 AC-DC €188

AC/DC CLAMP AMMETER

Overload indicator: "OL" and beep. Max clamp size:  $\varnothing$  30 mm. Negative polarity indicator (no indication for positive polarity). Auto switch off after 15 minutes. Low energy consumption. Removable test cables. Easy to use. Sold in a storage pouch.

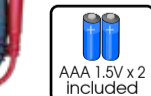

TECHNICAL INFORMATION

AC Amps (0.1A - 1A)	400A / 600A
DC amps (0.1A - 1A)	400A / 600A
AC voltage (0.001V - 1V)	4V / 40V / 400V / 600V
DC voltage (0.1mV - 1V)	400mV / 4V / 40V / 400V / 600V
Hz frequency	5Hz / 50Hz / 500Hz / 5kHz / 50kHz / 100kHz
Resistance (0.1 $\Omega$ - 0.01M $\Omega$ )	400 $\Omega$ / 4k $\Omega$ / 40k $\Omega$ / 400k $\Omega$ / 4M $\Omega$ / 40M $\Omega$
Continuity test	yes Diode test yes
Low battery indicator	yes
LCD display	3-1/2 digits 1999 points
Sampling rate	3 times per second
Dimension	117 x 76 x 18 mm Weight 121 g
Approval	CE IEC 61010-1, IEC 61010-2-032 CAT.III 600V Degré de pollution 2



9DN12 €110

INFRARED THERMOMETER

Contactless thermometer IR point can be displayed clearly. Easy to use with its 4 buttons. Emissivity selection 0.85 / 0.90 / 0.95. °C / °F selection. Laser pointer ON/OFF. Backlit display.

TECHNICAL INFORMATION

Temperature range	-30 à 550°C (-22 à 1022°F)
Operating temperature	0-50° C
Humidity	80% RH
Resolution	0.1°C / 0.1°F
Accuracy	$\pm$ 2.5% ou 3°C
Emissivity Selectable	0.85 / 0.90 / 0.95 (numerical adjustment)
Distance to spot ratio	12:1
Auto power off	15 seconds
Laser pointer	Class 2 Laser < 1 mW
Dimension	193 x 47 x 126 mm Weight 313 g



# 1000 V INSULATED TOOLS - VDE AND GS CERTIFIED



LIFETIME GUARANTEE



1000V  
18 PC.

IEC 60900:2012, VDE/GS

**25VE01MRV 1/4" €229** B

Contents		Weight
2335VE	5, 6, 7, 8, 9, 10, 11, 12, 13, 14	1.30
2035VE	H3, H4, H5, H6	
2221VE	100, 150	
2771VE55	2178VE05	



1000V  
14 PC.

IEC 60900:2012, VDE/GS

**35VE01MRV 3/8" €254** B

Contents		Weight
3335VE	10, 11, 12, 13, 14, 17, 19	2.16
3025VE	H5, H6, H8	
3221VE	150, 250	
3771VE08	3178VE08	



1000V  
16 PC.

IEC 60900:2012, VDE/GS

**45VE01MRV 1/2" €339** B

Contents		Weight
4335VE	8, 10, 12, 13, 14, 17, 19, 21, 22, 24	3.22
4025VE	H8, H10	
4251VE	125, 250	
4771VE10	4178VE08	



35 PC.

**9052001MRV €459** D

TOOL SET FOR ELECTRICIANS

Contents		Weight		
1471	PH0 x 75, PH1 x 100, PH2 x 100	8.69		
1472	3 x 75, 4 x 100, 5.5 x 125, 6.5 x 150			
1120MR	H1.5, H2, H2.5, H3, H4, H5, H6, H8, H10			
671606A	621606A	633608A	631808A	614608A
3611VE08	361110R			
631108	9CJ1120	7909505M		
6CB21	6CB02	651110		
67B355	67A107	6AG1120		
7622308, 7621010	7821500S	874052		



INSULATED OPEN END WRENCH SET

IEC 60900:2012, VDE/GS

**12FVE08MRN €167** B

Contents		Weight
10F0VE	10, 11, 12, 13, 14, 17, 18, 19	0.91

**12FVE10MRN €218** B

Contents		Weight
10F0VE	10, 11, 12, 13, 14, 16, 17, 18, 19, 22	1.28



INSULATED SCREWDRIVERS SET

IEC 60900:2012, VDE/GS

**30617MR €39** B

Contents		Weight
1471	PH1x100, PH2x100, PH3x150	0.86
1472	4x100, 5.5x125, 6.5x150, 8x175	

**30607MR €39** B

Contents		Weight
1478	PZ1x100, PZ2x100, PZ3x150	0.86
1472	4x100, 5.5x125, 6.5x150, 8x175	



Center cut.  
IEC DIN EN 60900, VDE/GS

**633608A €25** B

INSULATED BENT NOSE PLIERS

L mm	Cutting Capacities (Ø mm)	Weight
200	<ul style="list-style-type: none"> <li>4.0 Soft wire</li> <li>3.0 Semi-soft wire</li> <li>2.0 Hard wire</li> <li>1.6 Piano wire</li> </ul>	250



IEC 60900:2012, VDE/GS

**40603GP €68** B

INSULATED PLIERS SET

Contents		Weight	
611607A	621606A	631808A	0.89



INSULATED ADJUSTABLE WRENCH

mm	L mm	Weight	Price
3611VE06	24 164 167		€39 B
3611VE08	28 212 273		€49 B
3611VE10	32 260 497		€60 B
3611VE12	38 310 679		€79 B

New

## 86 TOOLS SET



**934086MRVD**

Contents		Weight
2335VE	5, 6, 7, 8, 9, 10, 11, 12, 13, 14	10.34
2035VE	H3, H4, H5, H6	
2221VE	100, 150 mm	
2771VE55	2178VE05	
3335VE	10, 11, 12, 13, 14, 15, 16, 17, 18, 19	
3235VE	8, 10, 12, 14	
3025VE	H8, H10	
3221VE	150, 250 mm	
3771VE08	3178VE08	



1471	PH0 x 75, PH1 x 100, PH2 x 100, PH3 x 150
1472	3 x 75, 4 x 100, 3.5 x 100, 5.5 x 125, 6.5 x 150, 8 x 175
1474	RB1 x 125, RB2 x 150
10F0VE	7, 8, 9, 10, 11, 12, 13, 14, 16, 17, 18, 19, 21, 22, 24
10F0VE	7, 8, 9, 10, 11, 12, 13, 14, 16, 17, 18, 19, 21, 22, 24



611607A	614608A
621606A	631808A
633608A	671606A

1/4" 3/8" LIFETIME GUARANTEE 86 PC.

## OPTIONAL

32 PC. 1/2" 1000V New



**945VE02MRVP 1/2" €549** B

Contents		Weight
4335VE	8, 10, 11, 12, 13, 14, 15, 16, 17, 18, 19, 20, 21, 22, 24, 27, 30, 32	3.96
4025VE	H4, H5, H6, H8, H10	
4035VE	H4, H5, H6, H8, H10	
4251VE	125, 250 mm	
4771VE10	4178VE08	
	84700011BS2	

## 1000 V INSULATED TOOLS

1 YEAR GUARANTEE

New



**1451VE11 €56** D

NF EN 60900 / CEI 60900

1000 V INSULATED SCREWDRIVER FOR TRIANGULAR SCREWS

Allows to work on the triangular screws of the connection boxes. Blade in treated steel. Body made of acetate. 1000 V insulated body, except for the tip to facilitate penetration into screw holes. Burnished tip.

**3432VE20M 3/8" €569** D

1000 V INSULATED TORQUE WRENCH

NF EN 60900 / CEI 60900 / NF EN ISO 6789-1-2017

Type II - Class A.

±3% torque accuracy (clockwise).  
Clockwise (CW) triggering.



PUSH BUTTON



Quick adjustment of the tightening torque by screwing or unscrewing the thumb wheel.



1000V

New



DELIVERED WITH A CALIBRATION CERTIFICATE

TOLERANCE +/- 3%

Torque range

Drive	Nm	Incr.	lbf.in	Number of teeth	Total length mm	Weight
3432VE20M	3/8"	4-20 Nm	1 Nm	40-180 lbf.in	72	230 530



## HAMMERS AND STRIKING TOOLS



### ENGINEER HAMMER

Hickory wood handle. Steel head.  
DIN 1041.

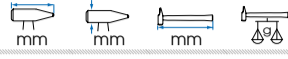

	mm	mm	mm	mm	
782130OS	103	22.5	300	373	€10.20 B
782150OS	116	27	320	615	€16 B
782180OS	128	33	350	932	€21 B



### BALL PEEN ENGINEER'S HAMMER

Hickory wood handle. Steel head.  
C45, BA876.



	mm	mm	mm	mm	
781108OS	230	23	300	318	€12 B
781112OS	340	27	325	428	€14 B
781116OS	440	28	350	562	€16 B
781124OS	540	31	365	656	€19 B
781132OS	700	33	375	803	€22 B
781140OS	910	40	405	1100	€26 B



### CARPENTER'S HAMMER

Hickory wood handle. Steel head.  
DIN 1041.



	mm	mm	mm	mm	
786116	133	30	335	740	€13 B
786120	144	31	340	830	€14 B
786124	147	32	380	920	€18 B



### RIVETING HAMMER

Three-component handle. Steel head.

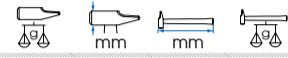

	mm	mm	mm	mm	
786229	500	29	325	657	€29 B
786238	1000	38	360	1364	€40 B
786244	1500	44	365	1778	€47 B
786250	2000	50	405	2460	€62 B



### BEVELLED EDGE CLUB HAMMER

Three-component handle. Steel head.

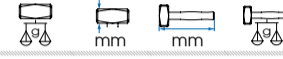

	mm	mm	mm	mm	
784315	1500	45	280	1733	€45 B

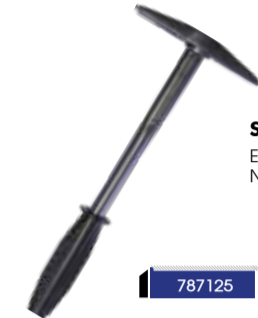

### SOLDER CHIPPING HAMMER

Epoxy finish. Horizontal peen.  
Nylon handle.

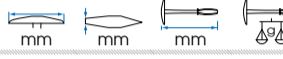

	mm	mm	mm	mm	
787125	120	18	275	255	€8,90 B



### HAMMER WITH INTERCHANGEABLE TIPS

Hickory wood handle. Steel head.  
Polyurethane tips.

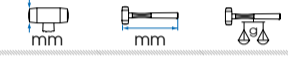

	mm	mm	mm	mm	
784232PIH	32	300	378		€23 B
784250PIH	50	320	910		€41 B



### HAMMER WITH INTERCHANGEABLE TIPS

Three-component handle. Aluminium head.  
Polyurethane tips.

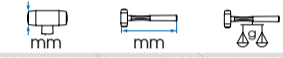

	mm	mm	mm	mm	
784227PAT	27	300	259		€29 B
784232PAT	32	300	298		€38 B
784240PAT	40	320	459		€53 B
784250PAT	50	320	584		€70 B



### SET OF LETTER STAMPS

A to Z with &.



	L mm	mm	mm	
11427SQ05	61	8x8	5	€32 B
11427SQ08	71	12.7x12.7	8	€57 B
11527SQ05	61	11x11	5	€49 B



### 76625C

7 PC.

€49 B

### DEAD BLOW DRIFT SET

Body filled with micro-balls to absorb the shock and reduce vibrations. Protects workpieces during their positioning or extraction.

Contents 0.87

160 mm	Cr-V
Ø 25 mm	polyamide
Ø 25 mm	brass
Ø 25 mm	aluminium



### 1005APR

5 PC.

€20 B

Contents	mm
761	Ø 4 x 120 mm
762	15 x 125 mm
763	3 x 120 mm
764	Ø 4 x 150 mm
765	5 x 130 mm



### 1006PRN

6 PC.

€30 B

Contents 0.57

764	Ø 2 x 30, Ø 3 x 40, Ø 4 x 50, Ø 5 x 50, Ø 6 x 50, Ø 8 x 50
-----	--

### 1009PRN

9 PC.

€50 B

Contents 1.6

764	Ø 2 x 30, Ø 3 x 40, Ø 4 x 50, Ø 5 x 50, Ø 6 x 50, Ø 8 x 50, Ø 10 x 65, Ø 12 x 70, Ø 14 x 75
-----	---



### 1025PRN

5 PC.

€29 B

Contents 0.79

762	13 x 100, 15 x 125, 17 x 150, 20 x 175, 23 x 200
-----	--



	A mm	B mm	L mm	mm	
7651005	5	10	130	46	€8 B
7651206	8	12	150	114	€8,50 B



### 1006GPN

6 PC.

€42 B

Contents 0.8

764G	Ø 2 x 140, Ø 3 x 150, Ø 4 x 180, Ø 5 x 200, Ø 6 x 210, Ø 8 x 220
------	--

### 1009GPN

9 PC.

€79 B

Contents 1.9

764G	Ø 2 x 140, Ø 3 x 150, Ø 4 x 180, Ø 5 x 200, Ø 6 x 210, Ø 8 x 220, Ø 10 x 230, Ø 12 x 250, Ø 14 x 290
------	--

New



### 1014GPL

4 PC.

€72 B

Contents 1.78

76612	Ø 10, Ø 12, Ø 14, Ø 16
-------	------------------------



### 1014GPRB

4 PC.

€104 B

Contents 1.7

76610	Ø 10, Ø 12, Ø 15, Ø 20
-------	------------------------



### 7622610GR

€17 B

### EXTRA-FLAT SHEATHED CHISEL

Reduced vibrations. Hand guard. Comfortable grip.

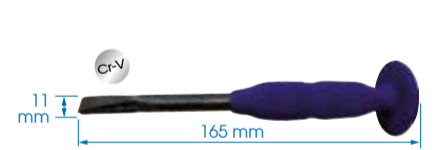

### 7651007G

€12 B

### SHEATHED CHISEL

Reduced vibrations. Hand guard. Comfortable grip.

## WORKSHOP TOOLS



### 7713308 200 mm

€67 B

### MANUAL VERNIER GAUGE

Stainless steel matte finish. Inside and outside measurement, depth gauge. Locking screw. Bevelled scale to reduce parallax effect.

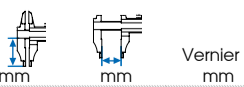

	mm	mm	Vernier mm
7713308	60	200	0.03



### 7714106 150 mm

€99 B

### DIGITAL VERNIER GAUGE

Locking by screw, precision adjustment knob. Digital screen. Printer output. Reset Functions, Value Lock, and Metric Conversion to Inch.

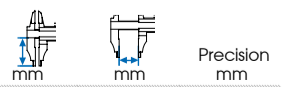

	mm	mm	Precision mm
7714106	40	150	0.01



### MEASURING TAPE

EU Class II accuracy standard approval. Tape automatically locks. Resistant. Non-slip. Anti-reflective tape.

Measurement in metric Two retrieval buttons.

7909402M	2 m x 16 mm	€6 B
7909403M	3 m x 16 mm	€7 B
7909405M	5 m x 19 mm	€9 B
7909408M	8 m x 25 mm	€15 B



Mini



### 7909505M

€7 B

### LIGHT & COMPACT MEASURING TAPE

EU Class II accuracy standard approval. Measurement in metric. Nylon coating. Ergonomic & shockproof ABS+TPE case.



## WORKSHOP TOOLS

Stop damaging your screwdrivers... Don't forget the pry bar !



**9TK014**

4 PC.

€56

**PRY BAR SET**

Minimises lever spring effect. Hardened and tempered steel, PP+TRP handle. Chrome vanadium. Thermoformed tray. 650x150x45 mm

Contents	Weight
204 mm	1.87
312 mm	
458 mm	
608 mm	



**9TK034**

4 PC.

€59

**PRY BAR SET**

Lady foot rolling head pry bar. Curved end ensures better leverage in small areas. Tapered point end for alignment work.

Contents	Weight
151 mm	1.73
305 mm	
405 mm	
504 mm	



**9TK024**

4 PC.

€249

**PRY BAR SET**

For heavy duty use. Includes a straight pry bar and 90°, 45° and 30° bent pry bars. Suitable for a wide range of uses. Extra long pry bars for more leverage.

Contents	Weight
625 mm, 90°	9.34
625 mm, 45°	
920 mm, 90°	
920 mm, 45°	



**74020**

€16

**AVIATION TIN SNIPS**

Right cut. Cutting length: 35 mm. Blades with serrated edges. Solid and comfortable handle with non-slip design. High strength torsion spring designed for longer life.



**74060**

€20

**AVIATION TIN SNIPS**

Right straight cut. Cutting length 75 mm. Blades with serrated edges. Solid and comfortable handle with non-slip design. High strength torsion spring designed for longer life.



**74260**

€18.60

**FIGURE TIN SNIPS**

Right cut. Cutting length: 35 mm. Blades with serrated edges. Solid and comfortable handle with non-slip design. High strength torsion spring designed for longer life.



**74270**

€18.60

**FIGURE TIN SNIPS**

Right straight cut. Cutting length: 35 mm. Blades with serrated edges. Solid and comfortable handle with non-slip design. High strength torsion spring designed for longer life.



**74416**

€25

**STRAIGHT PATTERN SNIPS**

Cutting length: 63 mm. Ideal for straight cuts or curves. Drop forged blades and handle. PVC grip material. Induction hardened blades 58-61 HRC

Cutting Capacities	
Copper: 1.5 mm	Hard Steel (HRC 30): 0.80 mm
Cold-rolled Steel: 1.20 mm	Stainless Steel: 0.70 mm

Cutting Capacities	
Copper: 1.1 mm	Hard Steel (HRC 30): 0.70 mm
Cold-rolled Steel: 0.94 mm	Stainless Steel: 0.53 mm

Cutting Capacities	
Copper: 1.80 mm	Hard Steel (HRC 30): 1 mm
Cold-rolled Steel: 1.50 mm	Stainless Steel: 0.90 mm

Cutting Capacities	
Copper: 1.80 mm	Hard Steel (HRC 30): 1 mm
Cold-rolled Steel: 1.50 mm	Stainless Steel: 0.90 mm

Cutting Capacities	
Copper: 2 mm	Hard Steel (HRC 30): 1.2 mm
Cold-rolled Steel: 1.60 mm	Stainless Steel: 1 mm

Light and anti-slip



**792112**

€19

**HIGH PERFORMANCE HACKSAW**

Adjustable blade angle (45°, 90°, 135° and 180°) by swivelling the scroll wheel. ABS+TPR handle. Blade length: 300 mm. Length: 510 mm. Weight: 555 g.



**1015GQ**

€53

**SECOND-CUT FILE SET**

Contents	Weight
7510210G	1.4
7520210G	
7540210G	
7550210G	
7530210G	

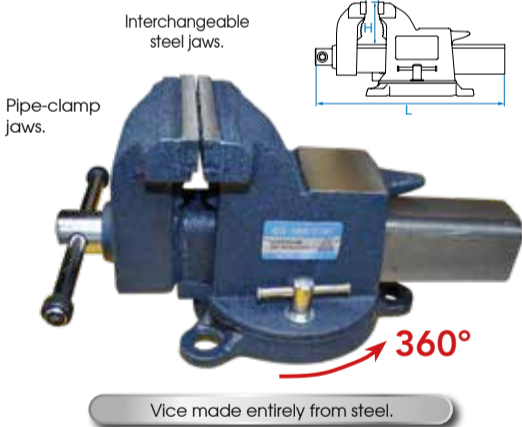

**SWIVEL BASE VICE**

	W mm	H mm	L mm	Weight kg	Price	
9TZ1105	166	130	67	365	11.0	€153
9TZ1106	200	155	76	422	14.5	€189
9TZ1108	225	200	89	492	18.0	€240
9TZ1110	250	250	102	572	25.6	€395



**6BB11**

€61

**MINI BUTANE TORCH**

Type of gas : butane (not included). Gasreservoir : 34 ml. Autonomy of 1 charge: 1 hour to 1 hour 30 minutes. Maximum temperature : 1300°C / 2050°F. Anti-flare system allowing the device to be used at 360°. Piezoelectric self-ignition system for instant flame. Built-in safety lock system. Super fast charging in just 5 seconds.

122 x 70 x 168 mm

**New**

**DCJ330**

16 PC.

€142

**HOLLOW PUNCHES**

Contents

DCJ	Ø3, Ø4, Ø6, Ø8, Ø10, Ø12, Ø14, Ø16, Ø18, Ø20, Ø22, Ø24, Ø26, Ø28, Ø30 mm
-----	--

**DCJ250**

32 PC.

€304

**HOLLOW PUNCHES**

Retractable centering tip.

Contents

DCJ	Ø2, Ø3, Ø4, Ø5, Ø6, Ø7, Ø8, Ø9, Ø10, Ø12, Ø14, Ø16, Ø18, Ø20, Ø22, Ø24, Ø26, Ø28, Ø30, Ø32, Ø34, Ø36, Ø38, Ø40, Ø42, Ø44, Ø46, Ø48, Ø50 mm
-----	--

**ZD10100C 100 sheets €25**

**MULTI PURPOSE WIPES**

Get rid of grease, oil, tar, paint, dirt, silicone, adhesives and more. Quick cleansing and time-efficient. One sheet is enough for normal use. Deep cleansing, fresh and moisturising. Effectively cleans and protects hands from all types of dirt without using toxic solvents. Eliminates up to 99.99% of bacteria. Non-REACH SVHC candidate list. Non-CA Prop 65 list of chemicals. Non-toxic solvents by SGS.

**Suitable for cleaning hands, surfaces, and tools**

No water required

Lemon oil formula

**79A2130**      **79A2230**

**RETRACTABLE TOOL LANYARD**

Reduces the risk of accidents related to falling tools. Maximum weight shown on a warning label. Nylon tether with a steel spring inside to absorb the shock of a dropped tool. Maximum load weight 3 kg.

	Capacity mm	Hook	Weight kg	Price
79A2130	800~1300	2 lock snaps	106	€12
79A2230	800~1300	fixed loop	89	€12.50

LIGHTING

1 YEAR GUARANTEE



UNDERHOOD LIGHTING



**9TA33AA** €49 <sup>B</sup>

6500 K  
10 W  
**1000 Lumen**  
500 mm  
360°



**9TA34AA** €132 <sup>B</sup>

6500 K  
20 W  
**2000 Lumen**  
1170 mm min. 1900 mm max.  
360°  
**9TA34P01A** €32 <sup>B</sup>  
RECHARGEABLE LI-ION BATTERY for 9TA34AA



**9TA44AZ** €199 <sup>B</sup>

6500 K  
16 W  
**1600 Lumen**  
Contents: 9TA44W x2, 87163  
\*inductive charger not included  
WIRELESS CHARGING DESIGN\*



**87163** €81 <sup>B</sup>

850 mm 1450 mm 2100 mm

Limited quantity

180 mm

7200 K  
1.5 W  
**145 Lumen**

**9TA28A** €16 <sup>B</sup>

220 mm

7200 K  
3 W  
**300 Lumen**

**9TA27A** €32 <sup>B</sup>

255 mm

6500 K  
7 W  
**400 Lumen**

**9TA241AA** €57 <sup>B</sup>

385 mm

+/- 6500 K  
7 W  
**600 Lumen**

**9TA262AA** €68 <sup>B</sup>

400 mm

+/- 6500 K  
7 W  
**700 Lumen**

**9TA264** €69 <sup>B</sup>

303 mm

ALUMINIUM  
6500 K  
8 W  
**800 Lumen**

**9TA268AA** €65 <sup>B</sup>

	Brightness	Color temperature	Dimensions (mm)	Battery life	Charging time	Battery	USB	Ingress Protection	Weight
9TA33AA	400 / 1000 lm	6500 K	L : 500 mm	2,2 h / 5,5 h	4,5 h	7,4 V - 2600 mAh Li-Ion	USB-C	IP20, IK07	487
9TA34AA	500 / 2000 lm	6500 K	L : 1170/1900 mm	2 h / 4 h / 6,5 h	4 h	3,6 V - 4800 mAh Li-Ion	USB-C	IP20, IK07	1110
9TA44AZ (9TA44W)	COB: 160/400/800 - SMD: 250 lm	6500 K	97 x 83 x 39 mm	COB: 10 h / 4,5 h / 2,5 h - SMD: 4,5 h	4 h	3,7 V - 2600 mAh Li-Ion	USB-C	IP54, IK07	300
9TA28A	145 lm	7200 K	L : 180 mm	2 h	2 h	3,7 V - 800 mAh Li-Ion	Micro USB-B	-	100
9TA27A	300 lm	7200 K	L : 220 mm	4 h	4,5 h	3,7 V - 2600 mAh Li-Ion	Micro USB-B	IP20, IK07	236
9TA241AA	400 lm	6500 K	L : 255 mm	3 h	3,5 h	3,7 V - 2600 mAh Li-Ion	Micro USB-B	IP54, IK07	310
9TA262AA	COB: 600 - SMD: 120 lm	6000 K - 7000 K	L : 385 mm	2 h / 15 h	4 h	3,7 V - 2600 mAh Li-Ion	Micro USB-B	IP54, IK07	322
9TA264	COB: 60-700 - SMD: 120 lm	5700 K - 7000 K	L : 220 mm / 400 mm	COB : 2 h / 16 h - SMD : 10 h	4 h	3,7 V - 2600 mAh Li-Ion	USB-C	IP54, IK07	322
9TA268AA	120 - 150/800 - 120/400 lm	6000 K - 6500 K	L : 475 mm	COB : 2 h / 16 h - SMD : 9 h	4 h	3,7 V - 2600 mAh Li-Ion	USB-C	IP54, IK07	322



LIGHTING

1 YEAR GUARANTEE



97 mm

6500 K  
8 W  
**800 Lumen**

**9TA44W €59<sup>B</sup>**

WIRELESS CHARGING DESIGN\*  
\*inductive charger not included

6500 K  
3 W  
**280 Lumen**

65 mm

**9TA52AA €49<sup>B</sup>**

INTELLIGENT MOTION SENSOR

+/- 6500 K  
3.5 W  
**350 Lumen**

120°

**9TA54A €54<sup>B</sup>**

210 mm

225 mm

5700 K  
**170 Lumen**

**9TA56A €16<sup>B</sup>**

2 REFLECTIVE STRIPS  
USB  
100% ACRYLIC

**87162KA €34<sup>B</sup>**

1500 mm  
700 mm

3 kg

0.65

238 mm

**9TA42AA €63<sup>B</sup>**

WIRED

288 mm

**9TA45AA €179<sup>B</sup>**

USB POWERBANK  
REMOVABLE BATTERY

210 mm

**9TA46AA €189<sup>B</sup>**

SPEAKER  
BLUETOOTH  
USB POWERBANK

127 mm

**9TA48AA €126<sup>B</sup>**

MAGNETIC BASE for 9TA48AA

7200 K  
30 W  
**3000 Lumen**

USB POWERBANK  
ALUMINIUM



+/- 6500 K  
30 W  
**3000 Lumen**

5700 K  
45 W  
**4500 Lumen**

6500 K  
40 W  
**4000 Lumen**

7200 K  
30 W  
**3000 Lumen**

	Brightness	Color temperature	Dimensions	Battery life	Charging time	Battery	USB	Ingress Protection	
9TA52AA	100/280 lm	6500 K	L : 65 mm	2 h / 5 h	2.5 h	3.7 V - 1500 mAh Li-ion	Micro USB-B	IP65	110
9TA54A	180/350 lm	6500 K	230 x 130 x 45 mm	2.2 h / 5.2 h	2.5 h	3.7 V - 700 mAh Li-ion	USB-C	IP54, IK07	140
9TA56A	30/60/170 lm	5700 K	H x W : 210 x 225 mm	2 h / 4 h / 6 h	2 h	3.7 V - 250 mAh Li-Po	USB-A	IP20, IK07	100
9TA42AA	3000 lm	6000 K - 7000 K	238 x 270 x 46 mm	-	-	-	-	IP54, IK07	1239
9TA44W	COB: 160/400/800 - SMD: 250 lm	6500 K	97 x 83 x 39 mm	COB : 10 h / 4.5 h / 2.5 h - SMD : 4.5 h	4 h	3.7 V - 2600 mAh Li-ion	USB-C	IP54, IK07	300
9TA45AA	750 / 1500 / 3000 / 4500 lm	5700 K	288 x 176 x 131 mm	2 h / 3.5 h / 6 h / 12 h	4.5 h	14.8 V - 5200 mAh Li-ion	USB-C	IP54, IK07	2140
9TA46AA	400 / 4000 lm	6500 K	210 x 210 x 100 mm	3.5 h / 12 h	3.5 h	11.1 V - 5200 mAh Li-ion	Micro USB-B	IP65, IK07	1450
9TA48AA	300 / 750 / 1500 / 2250 / 3000 lm	6500 K	171 x 127 x 72 mm	3 h / 4 h / 6 h / 12 h / 25 h	4.5 h	7.4 V - 5200 mAh Li-ion	USB-C	IP65, IK07	960



STORAGE AND TOOL SETS

NOMADIC STORAGE



**87711C**  
FABRIC TOOL BOX  
510 x 345 x 260 mm

600 denier Oxford waterproof fabric  
39 pockets

Tools pictured are not included.

€99

**New**  
**87723B** €68  
**MULTI-USE BACKPACK**

Wide opening for easy tool access.

600 denier Oxford waterproof fabric

PVC base

20 kg  
14 POCKETS



Back with honeycomb pads absorb vibrations and increase ventilation.

Adjustable chest strap

Velcro strap in the back, designed to secure the bag to a handle.

Tools pictured are not included.

**902A026MR** 26 PC. €169

Contents

1060	8, 10, 12, 13, 14, 17, 19, 21, 22, 24
1421	PH1 x 80, PH2 x 100
1422	3 x 75, 4 x 100, 5.5 x 125, 6.5 x 150, 8 x 175
764	Ø2x30, Ø3x40, Ø4x50, Ø5x50, Ø6x50, Ø8x50
786238	651610C 361112R
87A03AUS	



THE ESSENTIALS



**902A039MR** 39 PC. 1/2" €229

INCLUDED IN 902A039MR

Contents

4335M	8, 10, 11, 12, 13, 14, 15, 16, 17, 18, 19
4313MR01	477110G 425106



\*The guarantee is unlimited in time, excludes impact tools and toolbox.



**87A08** €34  
PLASTIC AND METAL TOOL BOX  
PP Reinforced shockproof shell.

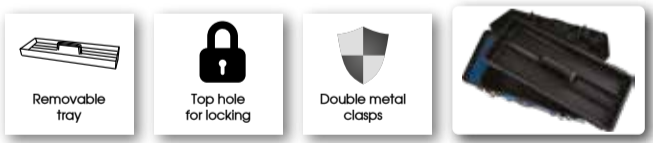

**41542MRV** 1/2" €195  
PLASTIC AND METAL TOOL BOX +42 PC.

Contents

87A08	
4335M	10, 11, 13, 14, 15, 16, 17, 18, 19, 21, 22, 24
1062	8, 9, 10, 11, 12, 13, 14, 17, 18, 19, 22, 24
1422	3 x 75, 5.5 x 100, 6.5 x 150
1421	PH0 x 60, PH1 x 100, PH2 x 100
1130M	H2.5, H3, H4, H5, H6, H8, H10
477110G	425105 4791
361108R	611106

\*The guarantee is unlimited in time, excludes toolbox.



**81 PC.**  
**7581MR01** 1/4" + 1/2" €299

422 x 360 x 110 mm

Contents

2335M	4, 4.5, 5, 5.5, 6, 7, 8, 9, 10, 11, 12, 13
4335M	10, 11, 12, 13, 14, 15, 17, 19, 22, 24
222104	276A04G 2792
425105R	463516R 463521R
475510G	4791R 75060
611106	631106 651610
7610405	7621505 7640406
782150	79831 9DC22
1025H	H3, H4, H5, H6, H7, H8
1025T	T20, T25, T30, T40
1421	PH1 x 80, PH2 x 100
1422	4 x 100, 5.5 x 125, 6.5 x 150
1120MR	H1.5, H2, H2.5, H3, H4, H5, H6, H8, H10
1147R	T10H, T15H, T20H, T25H, T27H, T30H, T40H
1060	6, 7, 8, 10, 12, 13, 14, 15, 17, 19



**103 PC.**  
**7503MR01** 1/4" + 1/2" €339

422 x 360 x 110 mm

Contents

2335M	4, 4.5, 5, 5.5, 6, 7, 8, 9, 10
4335M	8, 9, 10, 11, 12, 13, 14, 15, 16, 17, 18, 19, 20, 21, 22, 23, 24, 27, 30, 32
2375M	E4, E5, E6, E7, E8, E10
4375M	11, 12, 14, 16, 18
1062	8, 10, 11, 12, 13, 14, 15, 16, 17, 18, 19, 21, 22, 24
1930	8 x 10, 11 x 13, 12 x 14, 17 x 19
1025H	H2, H2.5, H3, H4, H5, H6, H7, H8, H10
1025M	M4, M5, M6, M8, M10
1025T	T15, T20, T25, T27, T30, T40, T45, T50
1421	PH1 x 80, PH2 x 100
1422	5.5 x 125, 6.5 x 150
463516R	463521R 212826
277155G	477110G
2178DF	361108R
222103, 222106	231206 2141
257145, 457210	425105R, 425110R
2792, 4791R	422302R 611107

Looking for the perfect complete trolley?  
We're sure to offer the right model for you!

**BASIC**  
series

€ 490<sup>D</sup>



87G386BA

87G386BAB

87G386BAG

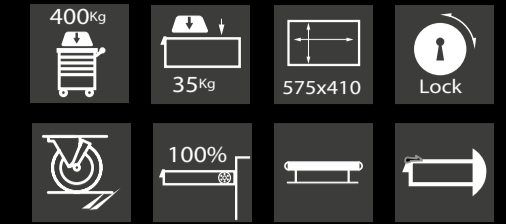

**BASIC TOOL TROLLEY**  
- 6 DRAWERS

87G386BA	Specifications	Dimensions (mm) L x D x H	58
	Total	752 x 538 x 807	
+ 127 x 50 mm wheels	752 x 538 x 982		
3 drawers	575 x 410 x 70		
3 drawers	575 x 410 x 140		



Combine with the tools set of your choice!

BASE WITH 178 TOOLS



**P938G178MD**

1/4" 1/2"

€ 530<sup>D</sup>

4 - 32 mm 6 - 24 mm

LIFETIME GUARANTEE

Contents

1062	6, 7, 8, 9, 10, 11, 12, 13, 14, 15, 16, 17, 18, 19, 21, 22, 24	2335M	5.5, 6, 7, 8, 9, 10, 11, 12, 13, 14
1421	PH1 x 100, PH2 x 38, PH3 x 150	4335M	10, 11, 12, 13, 14, 15, 16, 17, 18, 19, 21, 22, 24, 27, 30, 32
1422	8 x 150, 5.5 x 100, 6.5 x 38	1636H	H4, H5, H6, H7, H8, H10, H12
7610405	7621706, 7622007	1636M	M5, M6, M8, M10, M12
7640306, 7640406, 7640565, 7640607		1636T	T20, T25, T27, T30, T40, T45, T50, T55, T60
651710C	782130	1680H	H4, H5, H6, H7, H8, H10, H12
611108	631106	621106	
75363	770225	414710M	
457212	2792		
477110G	277155G		
797707	797807P02		
425105R	222302, 222304		
2178DF	2142	4791R	
7909505M			
		1120MR	H1.5, H2, H2.5, H3, H4, H5, H6, H8, H10
		1127R	T10H, T15H, T20H, T25H, T27H, T30H, T40H, T45H, T50H
		1025H	H3, H4, H5, H6
		1025S	3.0 x 0.5, 4.0 x 0.5, 5.0 x 0.8, 6.0 x 1.0
		1025U	T10H, T15H, T20H, T25H, T27H, T30H, T40H
		1025Z	PZ1, PZ2, PZ3
		1025P	PH1, PH2 x 2 ø6 mm, PH3
		1025T	T10, T15, T20, T25, T27, T30, T40

\*The guarantee is unlimited in time, excluding impact tools

+ 153 TOOLS = 331 TOOLS SET



**P934331MRV**

1/4" 1/2"

€ 835<sup>D</sup>

LIFETIME GUARANTEE

40D0	H6, H8, H10		
4066	M8, M9, M10, M12, M14		
4023	T20, T25, T27, T30, T40, T45, T50, T55, T60		
2120101	4 x 8 mm, 4 x 10 mm, 4 x 8 mm, 4 x 10 mm, 4.8 x 8 mm, 4.8 x 10 mm		
66HS07	66SB07	66HB07	66SS07
4945M	17, 19, 21		
4535M	17, 19, 32, 34, 36		
4415M	17, 19, 21		

+ 15 TOOLS = 193 TOOLS SET



**P934193MRV**

1/4" 1/2"

€ 795<sup>D</sup>

LIFETIME GUARANTEE

1062	27, 28, 29, 30, 32
373AM	8, 10, 11, 13, 17, 19, 22, 24
361112R	
601110R	

**FREE GIFT**  
1 LED LAMP 9TA44W  
FOR THE PURCHASE  
OF THE SET  
(P934331MRV / P934193MRV)



# THE UNMISSABLES 3

vol.

## WE ARE GLAD TO INTRODUCE OUR NEW TROLLEY'S RANGE.

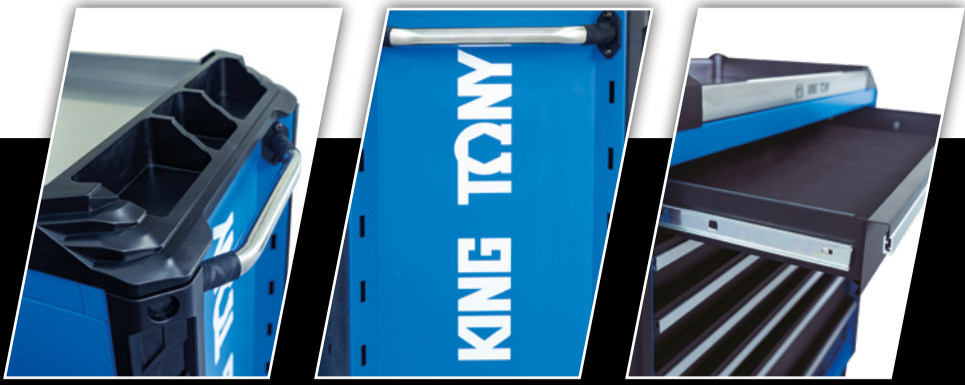

- Dynamic top cover
- Stainless steel worktop
- Structure strengthen
- Stylish bumpers
- Additional space for accessories

- Aluminum drawer handle
- RFS locking system (one drawer at a time)
- 5"x2" TPR high performance casters
- Central key lock
- 100% pull out drawer with auto-return

### Model D

87SQ316BABK €599<sup>D</sup>



87SQ317BABK €619<sup>D</sup>



87SQ318BABK €639<sup>D</sup>



Model	Specifications		Dimensions L x D x H (mm)	kg
	Total	Total + 127 x 50.8 mm wheels		
87SQ31_BABK			696x473x805	-
87SQ316BABK	3 drawers	570x380x70		65
87SQ317BABK	5 drawers	570x380x70		68
87SQ318BABK	7 drawers	570x380x70		71

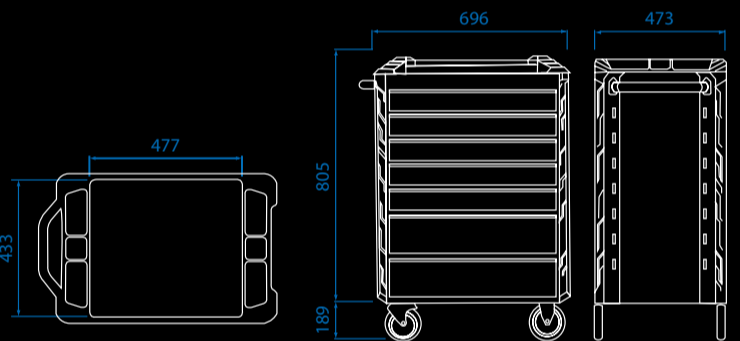

### Accessories



87SQ311A €25<sup>B</sup>  
SIDE PEGBOARD



• Dimensions (WxH): 325x683 mm

87SQ312A €18<sup>B</sup>  
DOCUMENT HOLDER



• Dimensions (WxHxD): 325x260x34 mm

87SQ322A €13<sup>B</sup>  
BOTTLE HOLDER



• Dimensions (WxHxD): 320x101x74 mm



87SQ323A €31<sup>B</sup>  
POWER TOOLS HOLDER



• Dimensions (WxHxD): 285x172x71 mm

87SQ333A €49<sup>B</sup>  
FOLDING SHELF



• Dimensions (WxHxD): 398x280x179 mm

87SQ313A €47<sup>B</sup>  
SHELF PEGBOARD

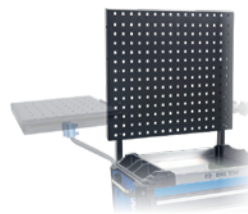

• Dimensions (WxH): 640x540 mm

87SQ331A €116<sup>B</sup>  
LAPTOP HOLDER



• Dimensions (WxHxD): 378x285x79 mm

87SQ332A €16<sup>B</sup>  
PHONE HOLDER



• Dimensions (WxH): 200x52 mm

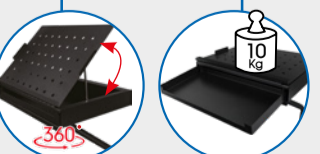

- 3 angles of adjustment are available 20°/45°/60°
- Underneath the rack has a drawer for stationery storage

87SQ342A €43<sup>B</sup>  
TRASH BIN-25 L



• Dimensions (WxHxD): 363x232x411

87SQ351A €31<sup>B</sup>  
PAPER HOLDER



- Dimensions (WxD): 280x308 mm
- For paper roll within 280 mm wide

**New**

**SQUAD**

# Model D<sup>+</sup>

87SQ337BABK

€835<sup>D</sup>

- 700 kg
- 35 kg
- 30 kg
- 850x380
- Lock
- Reinforcement
- Bumper
- RFS
- 100%

1 mm thick sheet metal

1 mm thick sheet metal

Specifications	Dimensions L x D x H (mm)		85
	Total	Total + 127 x 50.8 mm wheels	
87SQ337BABK	981 x 473 x 805	981 x 473 x 994	85
5 drawers	850 x 380 x 70		
2 drawers	850 x 380 x 150		

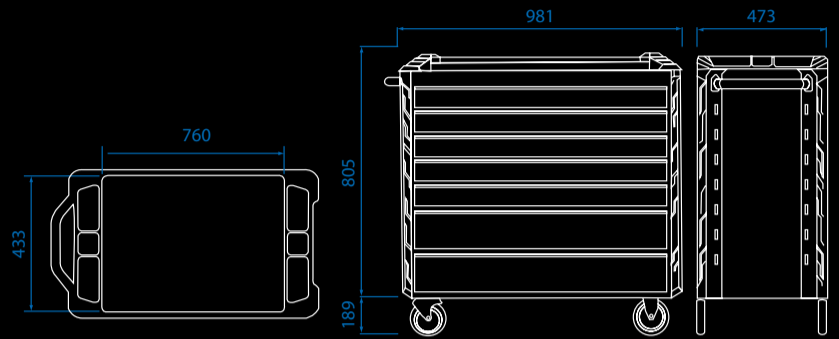
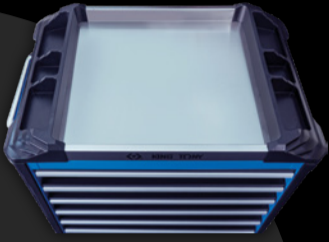

# Model D<sup>x</sup>

87SQ3210BABK

€929<sup>D</sup>

- 700 kg
- 35 kg
- 30 kg
- 35 kg
- Lock
- 100%
- Reinforcement
- Bumper
- RFS
- 570x380

1 mm thick sheet metal

0.8 mm thick sheet metal

Specifications	Dimensions L x D x H (mm)		103
	Total	Total + 127 x 50.8 mm wheels	
87SQ3210BABK	981 x 473 x 805	981 x 473 x 994	103
7 drawers	570 x 380 x 70		
1 drawer	570 x 380 x 150		
Large compartment	270 x 380 x 380		
Small compartment	270 x 380 x 280		

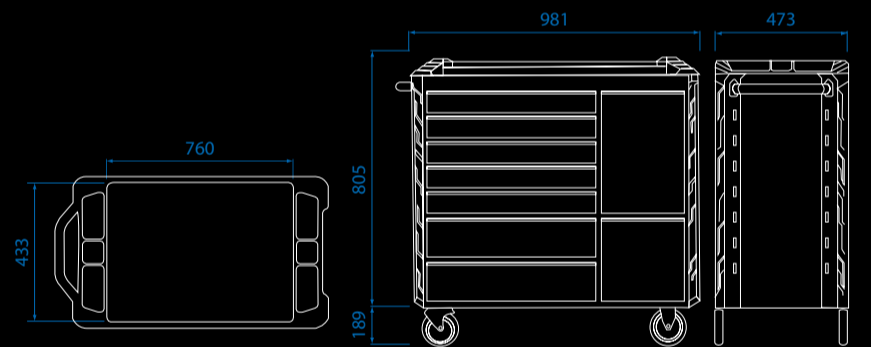

# Workbench

87SQ3410BABK

€1,439<sup>D</sup>

- Extra large worktop space: 1235 x 800 mm.
- Thick & strong Hevea wood top : 32 mm.
- Extra long metal handle bar for easy maneuver.
- 10 standard drawers.
- 1 perforated panel.
- 3 storage cabinets with different sizes, including locks.
- Wide range of compatible accessories
- Each side of the workbench is functional, and can accommodate several workstations.

- 700 kg
- 35 kg
- 35 kg
- 25 kg
- 570x380
- Lock
- Reinforcement
- Bumper
- RFS
- 100%

1 mm thick sheet metal

0.8 mm thick sheet metal

Specifications	Dimensions L x D x H (mm)		160
	Total	Total + 127 x 50.8 mm wheels	
87SQ3410BABK	1235 x 800 x 805	1235 x 800 x 994	160
8 drawers	570 x 380 x 70		
2 drawers	570 x 380 x 150		
Armoire 2 portes (haut)	654 x 376 x 205		
Armoire 1 porte (haut)	389 x 406 x 202		
Armoire 1 porte (bas)	791 x 523 x 329		
Vertical drawer	385 x 378		

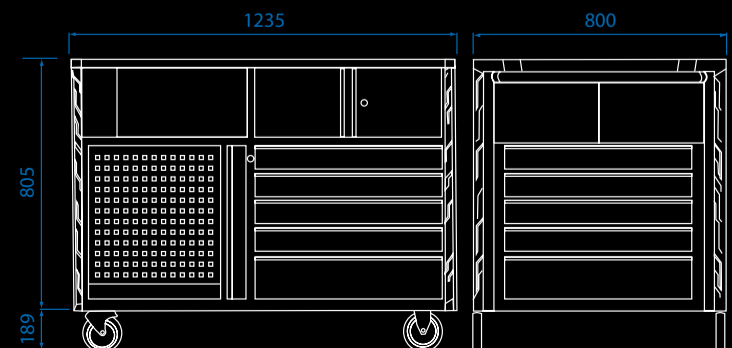

- lockable cupboard for storing valuable tools
- Hanging accessories can be added
- Sizes : 435 x 501 mm
- Additional storage space
- Trash bin or bottle holder can be added
- Vertical peg board drawer for hanging wrenches vertically.

- Strong worktop space
- Large metal handle
- Lockable cupboard for storing valuable tools
- 5 storage drawers
- Folding shelf can be added
- Sizes : 426 x 499 mm

FOCUS  
on...



9TA268AA **New**

€ 65<sup>B</sup>



9TA56A

€ 16<sup>B</sup>



FREE GIFT HAT - 9TA56A  
FOR THE PURCHASE  
OF THE SOCKET SET  
(4527MRE01P/4527MRE02P)



4527MRE01P € 204<sup>B</sup>

4527MRE02P € 204<sup>B</sup>



FREE GIFT MAGNETIC  
INSERT SET - 91000M  
FOR THE PURCHASE OF THE  
SOCKET SET (4524MRV04KP)



4524MRV04KP € 229<sup>B</sup>



FREE GIFT KNIFE -  
P794108A  
FOR THE PURCHASE  
OF THE TOOLBOX  
(P902100MKB2 / P902100MKG2)



P902100MKB2 € 429<sup>D</sup>

P902100MKG2 € 429<sup>D</sup>



477322GS **New**

€ 88<sup>B</sup>



Available in 2 colours

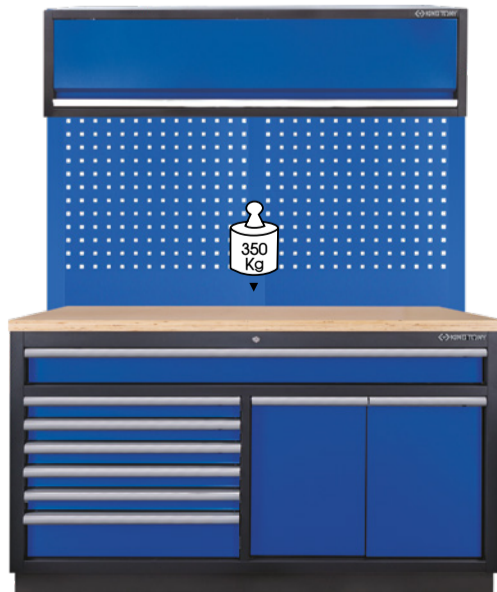

87D11AKBV

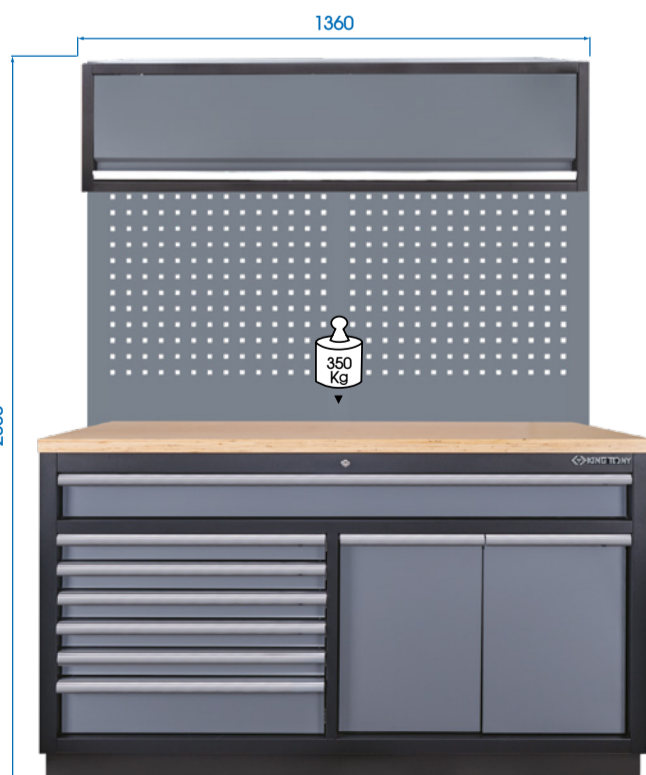

87D11AKGV

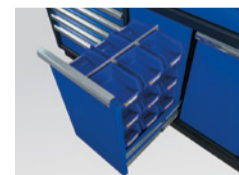

• Storage box



• Garage bin



• Safety mechanism

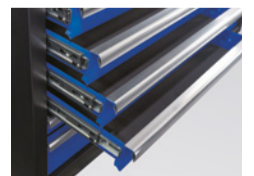

87D11AK(G/B)V **New**

€ 1,249<sup>D</sup>

Specifications	Dimensions L x D x H (mm)		Kg
	Total		
87SQ3210BABK	1360 x 760 x 2000		112
1 drawer	1272 x 403 x 84		
5 drawers	783 x 403 x 58		
1 drawer	783 x 403 x 137		
2 doors	284 x 371 x 531		



# STORAGE AND TOOL SETS

## NOMADIC STORAGE

**BASIC series**

- 0.6 mm thick sheet metal
- Folding handles
- Reinforced sheet metal
- Top hole for locking
- Foam layer

Available in 2 colours

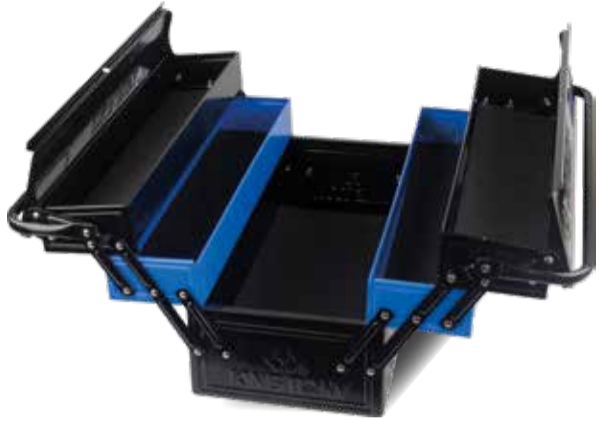

- 87A05A0KB
- 87A051A0KB
- 87A05A0KG
- 87A051A0KG

**STRENGTH series**

- 0.7 mm thick sheet metal
- Folding handles
- Reinforced sheet metal
- Top hole for locking
- Foam layer

**Stronger**  
Made with 0.7mm thick sheet metal.



**87A05A0KB** €50 470 mm  
**87A05A0KG** €50 **New**  
**BASIC METAL TOOLBOX** Overall dimensions: 470 x 220 x 260mm  
 4 compartments 468 x 107 x 53 mm  
 1 compartment 468 x 218 x 120 mm  
 4.9 kg

**87A051A0KB** €57 **New XL**  
**87A051A0KG** €57 **New XL**  
**BASIC XL METAL TOOLBOX** Overall dimensions: 530 x 220 x 260mm  
 4 compartments 528 x 107 x 53 mm  
 1 compartment 528 x 218 x 120 mm  
 5.5 kg

**87402** €78 470 mm  
**STRENGTH METAL TOOLBOX** Overall dimensions: 470 x 220 x 260mm  
 5.6 kg  
 4 compartments 468 x 107 x 53 mm  
 1 compartment 468 x 218 x 120 mm

**87408** €108 **XL** 530 mm  
**STRENGTH XL METAL TOOLBOX** Overall dimensions: 530 x 220 x 260mm  
 6.3 kg  
 4 compartments 528 x 107 x 53 mm  
 1 compartment 528 x 218 x 120 mm

- P794108A
- P902100MKB2
- P902100MKG2



**P902100MKB2** 1/4" + 1/2" €429   
**P902100MKG2** **New** 1/4" + 1/2" €429

**Contents**

- 2335M 4, 4.5, 5, 5.5, 6, 7, 8, 9, 10, 11, 12, 13
- 4335M 10, 11, 12, 13, 14, 15, 16, 17, 18, 19, 21, 22, 24
- 277155G 477910G
- 222104 4791 2142
- 1421 PH1x80, PH2x100, PH3x150
- 1422 5.5x100, 6.5x150, 8.0x175
- 1062 8, 10, 11, 12, 13, 14, 15, 16, 17, 18, 19, 21, 22, 24
- 651710C 611107 621106
- 631106 797707 7909505M
- 9TA28A 87A05A0KB / 87A05A0KG
- 1120MR H1.5, H2, H2.5, H3, H4, H5, H6, H8, H10
- 1025H H3, H4, H5, H6
- 1025P PH1, PH2, PH2, PH3
- 1025S 3, 4, 5, 6
- 1025Z PZ1, PZ2, PZ2, PZ3
- 1025T T10, T15, T20, T25, T27, T30, T40
- 1025U T10H, T15H, T20H, T25H, T27H, T30H, T40H
- 425110 457212
- 75363 770225

**BASIC series** LIFETIME GUARANTEE\* 100 PC. 1/4" 1/2"

*\*The guarantee is unlimited in time, excludes cutter, tape measure, penlight and toolbox*

**902076MR** 1/2" 76 PC. €388   
**902089MR03** 88 PC. €516   
**902083MR** 83 PC. €514

**Contents** 24.8

- 4335MR 10, 11, 12, 13, 14, 15, 16, 17, 18, 19, 20, 21, 22, 23, 24, 27, 30, 32
- 475510G 4791R
- 463521R 425105R, 425110R
- 457212 445218FR 422302R
- 1062 6, 7, 8, 9, 10, 11, 12, 13, 14, 15, 16, 17, 18, 19, 20, 21, 22, 24
- 1900 6 x 7, 8 x 10, 11 x 13, 12 x 13, 17x19, 22 x 24
- 1120MR H1.5, H2, H2.5, H3, H4, H5, H6, H8, H10
- 1147 T10H, T15H, T20H, T25H, T27H, T30H, T40H
- 1421 PH2 x 38, PH3 x 150
- 1422 3 x 75, 5 x 100
- 611107 631106 651610C
- 782180 361108R 791112 87402



The differences between the 2 models are noted in bold.

**902091MR** 1/2" 91 PC. €524   
**902103MR07** 103 PC. €649   
**902098MR1** 98 PC. €599

**Contents** 24.8

- 4335MR 10, 11, 12, 13, 14, 15, 16, 17, 18, 19, 20, 21, 22, 23, 24, 27, 30, 32
- 475510G 4791R
- 463521R 425105R, 425110R
- 457212 445218FR 422302R
- 1062 8, 9, 10, 11, 12, 13, 14, 15, 16, 17, 18, 19, 21, 22, 23, 24, 27, 30, 32
- 1120MR H1.5, H2, H2.5, H3, H4, H5, H6, H8, H10
- 1147 T10H, T15H, T20H, T25H, T27H, T30H, T40H
- 1421 PH0 x 60, PH1 x 100, PH2 x 100, PH3 x 150
- 1422 3 x 75, 4 x 100, 5 x 75, 5.5 x 125, 6.5 x 150, 8 x 175
- 611107 631106 651610C
- 623208 643110 601110R
- 782180 361112R 791112
- 2x115, 3x125, 4x150, 5x165, 6x180, 8x200, 12x230, 14x250
- 20x175, 26x300 7909303C 87402

INCLUDED IN 902089MR03 / 902103MR07

**Contents**

- 1812MR 1080 8, 10, 11, 12, 13, 14, 16, 17, 18, 19, 22, 24

INCLUDED IN 902083MR / 902098MR1

**Contents**

- 3732M 8, 10, 11, 12, 13, 17, 19

*\*The guarantee is unlimited in time, excludes tape measure, hacksaw blade, impact tools and toolbox.*



## STORAGE AND TOOL SETS

### NOMADIC STORAGE



MODULAR STACKING BOX  
**MS BOX**

#### MODULAR STACKING BOX

**S | 874051 €49**  
456 x 372 x 115 mm

**M | 874052 €56**  
456 x 372 x 155 mm

**L | 874053 €69**  
456 x 372 x 262 mm

#### ROLLER SUPPORT

**| 874059 €69**  
655 x 490 x 170 mm



LIFETIME GUARANTEE\*

112 PC.

1/4"

1/2"



**9052002MRV 1/4" + 1/2" €429**

#### TOOL BOX "THE ESSENTIALS"

Contents		10.46
2335M	4, 4.5, 5, 5.5, 6, 7, 8, 9, 10, 11, 12, 13, 14	
4335M	10, 13, 15, 16, 17, 18, 19, 20, 21, 22, 24, 27, 30, 32	
275555G	477310GS	2179DF 2142
425110R	2792 4791	75363 770225
1120MR	H1.5, H2, H2.5, H3, H4, H5, H6, H8, H10	20002UB
1147R	T10H, T15H, T20H, T25H, T27H, T30H, T40H, T45H, T50H	
1025H	H3, H4, H5, H6	1025P PH1, PH2 x 2, PH3
1025S	3.0, 4.0, 5.0, 6.0	
1025T	T10, T15, T20, T25, T27, T30, T40	
1025U	T10H, T15H, T20H, T25H, T27H, T30H, T40H	
1025Z	PZ1, PZ2 x 2, PZ3	
Ø 4 x 120	15 x 125	3 x 120
Ø 4 x 150	5 x 130	782130OS
1062	8, 9, 10, 11, 12, 13, 14, 16, 17, 18, 19, 22	361110R
631108	651110	621106 611107
6AB3175	9TA281	7909505M 874052

\*The guarantee is unlimited in time, excludes impact tools, tape measure, penlight and toolbox

219 PC.



LIFETIME GUARANTEE\*

#### Metric and Imperial dimensions!

**| 911000CR07 1/4"+3/8"+1/2" €1,120**

660 x 374 x 307 mm

Contents 48.1

2335M	4, 4.5, 5, 5.5, 6, 7, 8, 9, 10, 11, 12, 13	
2335S	5/32", 3/16", 7/32", 1/4", 9/32", 5/16", 11/32", 3/8", 7/16", 1/2"	
2235M	4, 5, 5.5, 6, 7, 8, 9, 10, 11, 12, 13	
2235S	5/32", 3/16", 7/32", 1/4", 9/32", 5/16", 11/32", 3/8", 7/16", 1/2"	
3330M	6, 7, 8, 9, 10, 11, 12, 13, 14, 15, 16, 17, 19, 20, 21, 22	
3330S	3/8", 7/16", 1/2", 9/16", 5/8", 11/16", 3/4", 13/16"	
4330M	10, 11, 12, 13, 14, 15, 16, 17, 18, 19, 20, 21, 22, 23, 24, 27, 30, 32	
4330S	3/8", 7/16", 1/2", 9/16", 5/8", 11/16", 3/4", 13/16", 7/8", 15/16", 1"	
1900	8 x 9, 10 x 11, 12 x 13, 14 x 15, 18 x 19	
5900	1/4"x5/16", 3/8"x7/16", 1/2"x9/16", 5/8"x11/16", 3/4"x7/8", 13/16"x7/8"	
1062	6, 7, 8, 9, 10, 11, 12, 13, 14, 15, 16, 17, 19, 20, 21	
5060	1/4", 5/16", 3/8", 7/16", 1/2", 9/16", 5/8", 11/16", 3/4", 13/16", 7/8", 1"	
1970	6x7, 8x9, 10x11, 12x13, 14x15, 16x17, 18x19	
5970	1/4"x5/16", 3/8"x7/16", 1/2"x9/16", 5/8"x11/16", 3/4"x7/8", 15/16"x1", 1-1/16"x1-1/8"	
1930	10 x 11, 12 x 14, 14 x 17	
1120MR	H1.5, H2, H2.5, H3, H4, H5, H6, H8, H10	
1130S	3/32", 1/8", 5/32", 3/16", 1/4", 5/16", 3/8"	
1421	PH0, PH1, PH2, PH2, PH3	
1422	3x75, 6.5x38, 6.5 x 100, 6.5x150, 8x175	
463516M, 463521R		
277955G	377908G	477910G
2792	3792	4791
2813	3812	4813
222102, 222104		
322103, 322106	425105R, 425110R	
345208F	445215FR	
357108	457210	
781160S	361108P, 361112P	
7621505, 7621706, 7622007, 7622410		
7640406, 7640607, 7640808	7610506	
623107	631106	611107
68S07	68SS07	651110C
68HS07	68HB07	
601110R	791112	874116B

\*The guarantee is unlimited in time, hacksaw blade, impact tools and toolbox.

### METAL TOOL CHEST

STRENGTH XL series

Gas spring



660 mm

455 mm



**8741710BG €599**

#### XL TOOL CHEST (EXTRA DEEP)

3 drawers and 1 hold are compatible with the #6 trays (560 x 375mm)

Specifications	Dimensions (mm) L x D x H	51.2
Total	660 x 455 x 483	
Top	646 x 420 x 70	
6 Drawers	169 x 410 x 48.5	
1 Drawer	169 x 410 x 154	
2 Drawers	576 x 410 x 48.5	
1 Drawer	576 x 410 x 75	

STRENGTH series



660 mm

307 mm

**874116B**

6 drawers

**874119B**

9 drawers

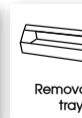
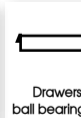

**874116B €323**

**874119B €394**

#### TRANSPORTABLE TOOL CHEST

Specifications	Dimensions (mm) L x D x H	25.4
Total	660 x 307 x 374	
Top	646 x 290 x 60	
3 Drawers	170 x 275 x 50	
2 Drawers	569 x 275 x 50	
1 Drawer	569 x 275 x 75	
Total	660 x 307 x 427	
Top	646 x 290 x 60	
6 Drawers	170 x 275 x 50	
2 Drawers	569 x 275 x 50	
1 Drawer	569 x 275 x 75	



# STORAGE AND TOOL SETS

## WORKSHOP STORAGE



874411B

€244

### TOOL CART WITH 3 SHELVES

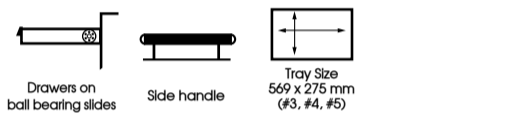

Specifications	Dimensions (mm) L x D x H	
Total	716 x 410 x 750	23.2
Total + 75 mm wheels	716 x 410 x 855	
1 drawer	569 x 275 x 75	

PRO series



Available in 2 colours



ST874347B(-PG)

€599

### PRO TOOL TROLLEY - 7 DRAWERS

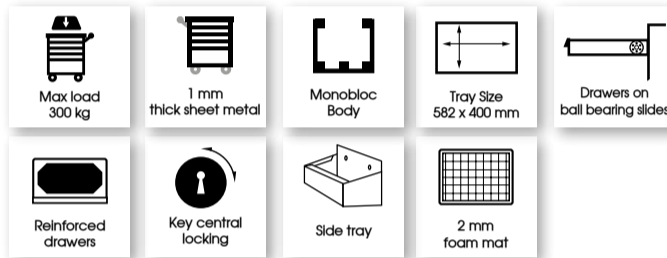

Specifications	Dimensions (mm) L x D x H	
Total	680 x 460 x 823	62
Total + 127 x 32 mm wheels	680 x 460 x 953	
5 drawers	582 x 400 x 76	
2 drawers	582 x 400 x 156	

STRENGTH series



874347BW

€755

### STRENGTH TOOL TROLLEY - 7 DRAWERS



Specifications	Dimensions (mm) L x D x H	
Total	670 x 460 x 812	64
Total + 127 x 32 mm wheels	670 x 460 x 960	
5 drawers	576 x 380 x 75	
2 drawers	576 x 380 x 154	

BUMPER series

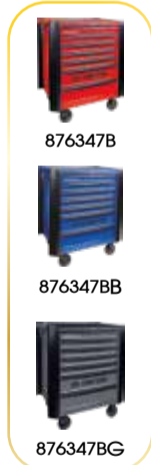

Available in 3 colours



876347B(-B/-G)

€799

### BUMPER TOOL TROLLEY - 7 DRAWERS

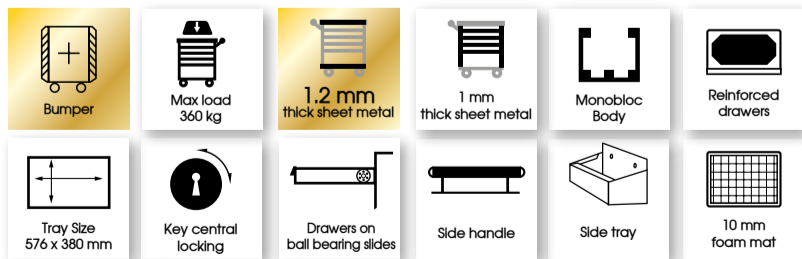

Specifications	Dimensions (mm) L x D x H	
Total	820 x 475 x 775	66.14
Total + 127 x 32 mm wheels	820 x 475 x 940	
5 drawers	576 x 380 x 75	
2 drawers	576 x 380 x 154	

BUMPER RFS series

8 DRAWERS



876348GG

€939

### BUMPER RFS TOOL TROLLEY - 8 DRAWERS

You cannot open more than 1 drawer at a time to prevent tilting risks!

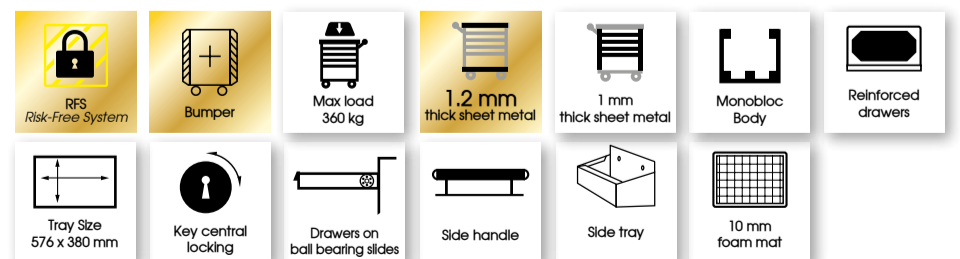

Specifications	Dimensions (mm) L x D x H	
Total	820 x 475 x 775	72.14
Total + 127 x 32 mm wheels	820 x 475 x 940	
7 drawers	576 x 380 x 75	
1 drawers	576 x 380 x 154	

\*RFS - Risk-Free System



# STORAGE AND TOOL SETS

## EVAWAVE FOAM TRAY SET



**91306MRE #7**  
**€59**  
 Contents 1  
 1930 8 x 10, 10 x 12, 11 x 13, 12 x 14, 17 x 19, 19 x 22

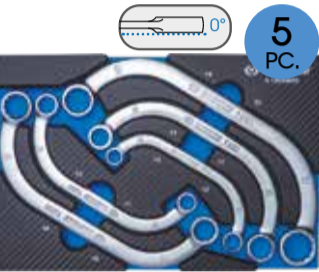

**91905MRE #7**  
**€103**  
 Contents 0.82  
 1950 10 x 12, 11 x 13, 14 x 17, 16 x 18, 19 x 22



**9122A08MRE #9**  
**€179**  
 Contents 1.6  
 373AM 8, 10, 11, 13, 17, 19, 22, 24



**9122A14MRE #9**  
**€259**  
 Contents 2.26  
 373AM 8, 9, 10, 11, 12, 13, 14, 15, 16, 17, 18, 19, 22, 24



**91112MRE #9**  
**€102**  
 Contents 2.6  
 1900 6x7, 8x9, 10x11, 12x13, 14x15, 16x17, 18x19, 20x22, 21x23, 24x27, 25x28, 30x32



**94539MRE 1/2" #9**  
**€225**  
 Contents 5.26  
 4235M 10, 13, 16, 17, 18, 19, 21, 22, 24  
 4023 T20, T25, T27, T30, T40, T45, T50, T55, T60  
 4025 H4, H5, H6, H7, H8, H10, H12, H14, H17, H19  
 4026 M8, M10, M12, M14  
 4033 T30, T40, T45, T50  
 4035 H5, H6, H8

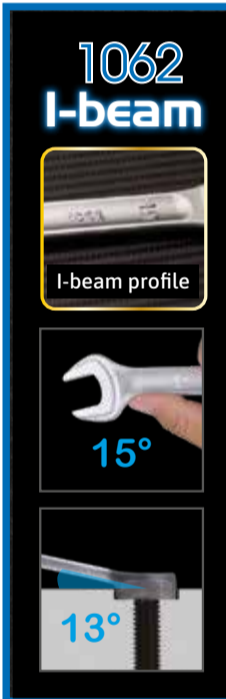

**912D19MRE1 #9**  
**€118**  
 Contents 2.5  
 1062 6, 7, 8, 9, 10, 11, 12, 13, 14, 15, 16, 17, 18, 19, 20, 21, 22, 23, 24

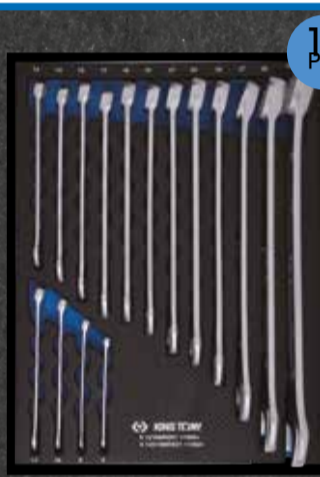

**912D16MRE1 #9**  
**€132**  
 Contents 3.3  
 1062 6, 8, 10, 11, 13, 14, 16, 17, 18, 19, 21, 22, 24, 27, 30, 32



**912D20MRE #9**  
**€149**  
 Contents 3.3  
 1062 6, 7, 8, 9, 10, 11, 12, 13, 14, 15, 16, 17, 18, 19, 21, 22, 24, 27, 30, 32



**912D05MRE #9**  
**€95**  
 Contents 2.6  
 1062 27, 28, 29, 30, 32



**91019GRE #9**  
**€84**  
 Contents 1.7  
 764G Ø 2, Ø 3, Ø 4, Ø 5, Ø 6, Ø 8  
 762G 18, 22 mm  
 9TK1 9TK112



**91009GPE #9**  
**€95**  
 Contents 2  
 764G Ø 2, Ø 3, Ø 4, Ø 5, Ø 6, Ø 8, Ø 10, Ø 12, Ø 14



**922308TRE #9**  
**€69**  
 Contents 1.85  
 1163TR T10, T15, T20, T25, T30, T40, T45, T50



**990222MRE #9**  
**€135**  
 Contents 1.94  
 1120MR H1.5, H2, H2.5, H3, H4, H5, H6, H7, H8  
 1147R T10, T15, T20, T25, T27, T30, T40, T45, T50  
 651710C 631106  
 611108 621106



**990407GQE #9**  
**€155**  
 Contents 1.2  
 7711106A 7734020  
 7909405M 9DC23  
 797107 74408  
 793204

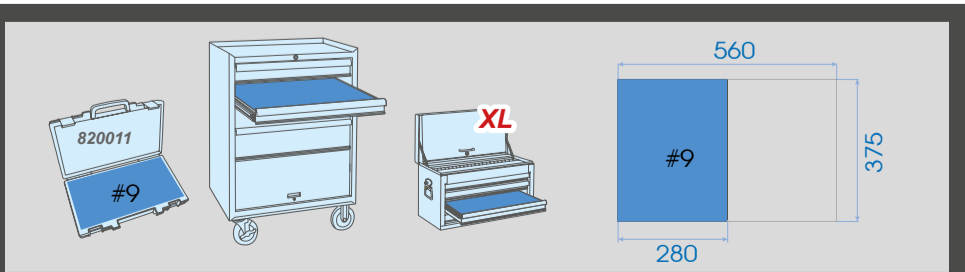
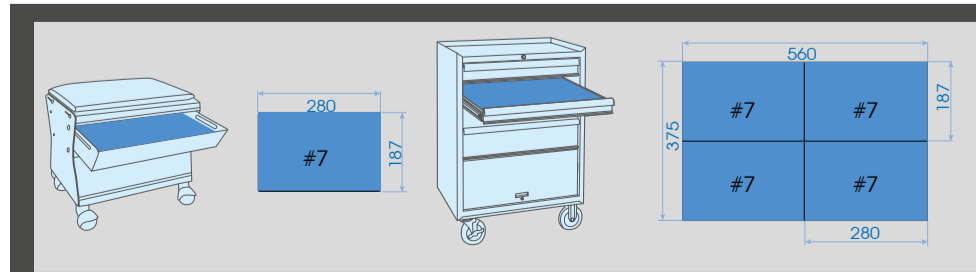

STORAGE AND TOOL SETS





EVAWAVE FOAM TRAY SET



3/4" 14 PC.

**96314MRE01** 3/4" #6 €339 B

Contents  10.8







	6335M	33, 34, 35, 36, 38, 41, 46, 50
	677820FS	
	625104, 625108, 625116	
	657220	6814



19 PC.

**990319PRE** #6 €143 B

Contents  2.44



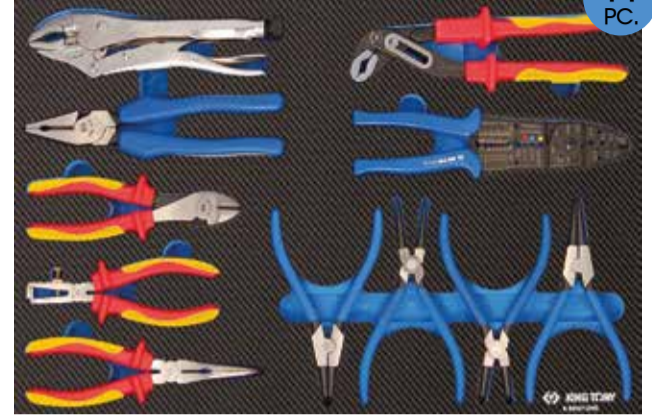









	1421	PH0 x 60
	1422	3 x 75, 4 x 100, 5.5 x 125, 6.5 x 150, 8 x 175
	1427	T10H x 75, T15H x 75, T20H x 100, T25H x 100, T27H x 100, T30H x 125, T40H x 150
	1428	PZ1x100, PZ3x150
	762G	22
	764G	ø4, ø5, ø6



11 PC.

**990421GNE** #6 €265 B

Contents  3.5

	68HB07		68HS07		68SB07
	68SS07		623607A		671606A
	633608A		651610A		
	611209		6721		601110R



17 PC.





**990217GRE03** #6 €248 B

Contents  2.44

**990217GRE04** #6 €248 B

Contents  2.44

990217GRE03 → 781116 990217GRE04 → 782150







	764	3, 4, 5, 6
	7610506	7671705
	601110R	611108 623107
	631405	631108 651710C
	66SB07	66SS07 66HB07 66HS07



8 PC.

**990408GQE** #6 €266 B

Contents  2.35

	762G	18, 22		785116
	9TK108, 9TK112		786238	
	784310		782027	



9 PC.

**990409TQE** #6 €135 B

Contents  3.5







	7906312		7909305M		797107
	7510208G		7520208G		7550208G
	7530208G		7540208G		792112



11 PC.

**99AA01E** #6 €283 B

Contents  3.7









	1453	5, 6, 7, 8, 10			
	9AA16		9AA13		9AA21
	9AA17		9AA25		9AA31



11 PC.

**994411MQUE** #6 €267 B

Contents  4.7

	7713308		4945MX	17, 19, 21,		34440A
	9AE32110		6AB3175		9AE43	
	159609		159609		158609	

**Security :**  
Each tool has its own location, allowing a complete check at the end of the intervention, and thus avoiding forgetting a tool in a machine or an engine.

**Benefit:**  
Tools are quickly located and immediately stored after use to prevent loss. The two- or three-color manufacturing offers quick identification of the tools via their silhouettes.

**Efficiency :**  
Durable, dirt-repellent materials for easy maintenance.

# STORAGE AND TOOL SETS

## 155 TOOLS SET



\*The guarantee is unlimited in time, excludes impact tools

### 934008MED7

€651

### 934008MED8

€645

Contents		17.69	
2335M	5.5, 6, 7, 8, 9, 10, 11, 12, 13, 14	213312DF	2142
4335M	10, 11, 12, 13, 14, 15, 16, 17, 18, 19, 21, 22, 24, 27, 30, 32	222102, 222104	2792
4235M	8, 9, 10, 12, 13, 14, 15, 16, 17, 18, 19	425105R, 425110R	4791R
4375M	E10, E12, E14, E16, E18	1062	6, 7, 8, 9, 10, 11, 12, 13, 14, 15, 16, 17, 18, 19, 20, 21, 22, 23, 24
4033	T30, T40, T50, T55	1421	PH1 x 80, PH2 x 38, PH2 x 100, PH3 x 150
4049	M8, M9, M10, M12	1422	3 x 75, 4 x 100, 5.5 x 125, 6.5 x 38, 6.5 x 150, 8 x 175
4036	M8, M10, M12	1120MR	H1.5, H2, H2.5, H3, H4, H5, H6, H7, H8
4035	H6, H8, H10	1147R	T10, T15, T20, T25, T27, T30, T40, T45, T50
4026	M14	651710C	631106
402B	M16, M18	611107	621106
1025H	H3, H4, H5, H6	67HS07	67SB07
1025U	T7H, T8H, T9H, T10H, T15H, T20H, T25H, T27H, T30H, T40H	67HB07	67SS07
1025Z	PZ1, PZ2, PZ3	7610405	782130
1025P	PH1, PH2, PH3	7621706, 7622007	
934008MED7 →	275555G	7640305, 7640406, 7640565, 7640607	
	475510G		
934008MED8 →	277155G		
	477110G		
	257145	2178DF	

## 3 trays + 2 of your choice

### BASE WITH 108 TOOLS

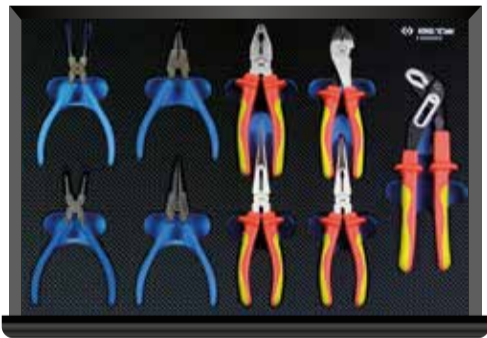

Contents	
2335M	4, 4.5, 5, 5.5, 6, 7, 8, 9, 10, 11, 13, 14
2235M	4, 5, 5.5, 6, 7, 8, 9, 10, 11, 13, 14
275555G	222102, 222104
2142	2813
2792	
4335M	8, 9, 10, 11, 12, 13, 14, 15, 16, 17, 18, 19, 20, 21, 22, 23, 24, 25, 26, 27, 28, 29, 30, 32
4635	16, 20, 8
475510G	457212
445218F	4791
425103, 425105, 425110	
4033	T20, T25, T27, T30, T40, T45, T50, T55, T60
4035	H4, H5, H6, H7, H8, H10, H12, H14, H17
68HB07	68HS07
68SS07	68SB07
633608A	631808A
651610A	611607A
623607A	
1421	PH0 x 60
1422	3x75, 4x100, 5.5x125, 6.5x150, 8x175
1427	T10H x 75, T15H x 75, T20H x 100, T25H x 100, T27H x 100, T30H x 125, T40H x 150
1428	PZ1x100, PZ3x150
762G	22
764G	ø4, ø5, ø6

## + 58 TOOLS = 166 TOOLS SET

### 934016MED4

1/4" + 1/2"

€819



Contents	
1062	6, 7, 8, 9, 10, 11, 12, 13, 14, 15, 16, 17, 18, 19, 20, 21, 22, 23, 24, 25, 26, 27, 28, 29, 30, 32
1900	6x7, 8x9, 10x11, 12x13, 14x15, 16x17, 18x19, 20x22, 21x23, 24x27, 25x28, 30x32
1120MR	H1.5, H2, H2.5, H3, H4, H5, H6, H8, H10
1147R	T10H, T15H, T20H, T25H, T27H, T30H, T40H, T45H, T50H
3204	781140OS

## + 49 TOOLS = 157 TOOLS SET

### 934016MED5

1/4" + 1/2"

€851



Contents	
1062	8, 9, 10, 11, 12, 13, 14, 15, 16, 17, 18, 19, 22, 24, 27, 29, 30, 32
1080	8, 9, 10, 11, 12, 13, 14, 16, 17, 18, 19
1130M	H1.5, H2, H2.5, H3, H4, H5, H6, H8, H10
1127R	T10H, T15H, T20H, T25H, T27H, T30H, T40H, T45H, T50H
601110R	782180OS

**+** choose

\*The guarantee is unlimited in time, excludes impact tools



## STORAGE AND TOOL SETS

### 187 TOOLS SET

932187MED1

1/4" + 1/2"

€1,073 D

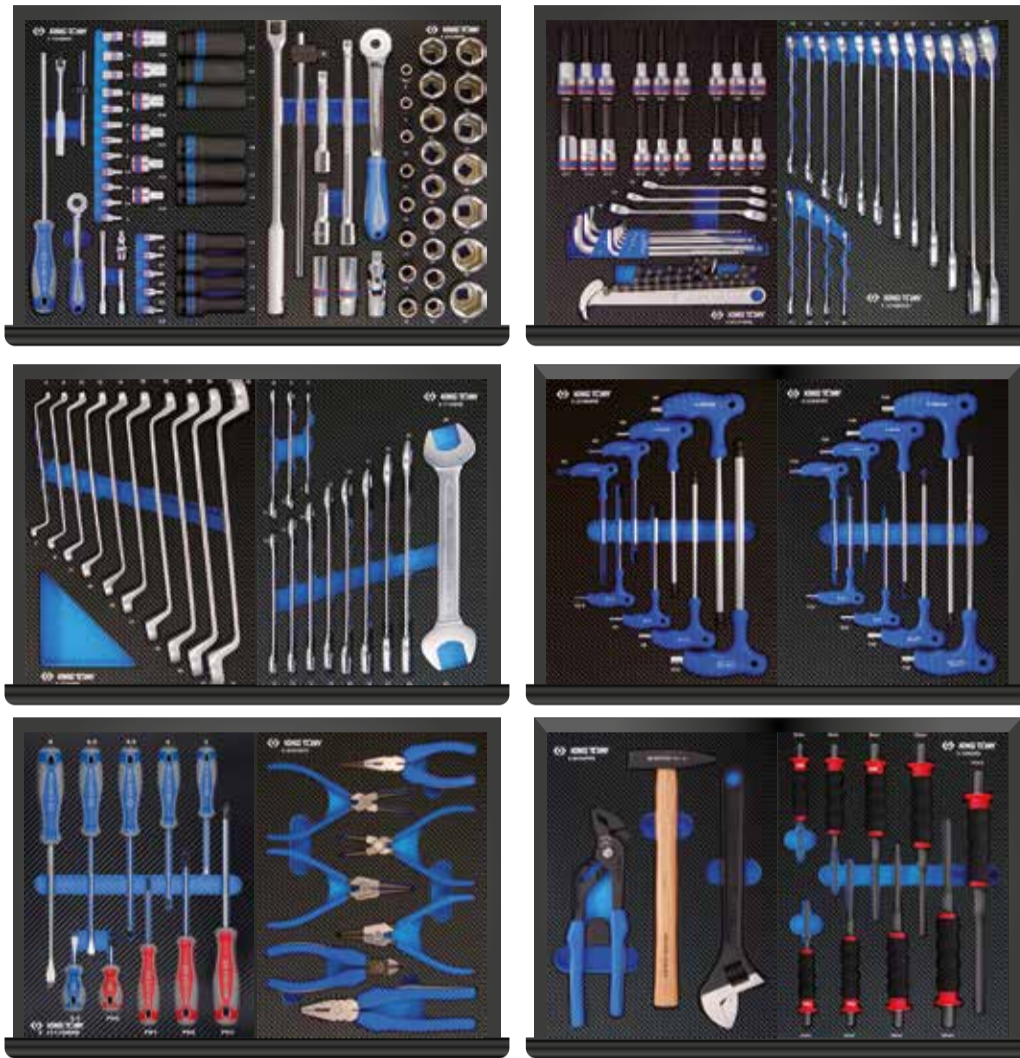

Contents

28.84

2335M	4, 4.5, 5, 5.5, 6, 7, 8, 9, 10, 11, 12, 13	1062	6, 8, 10, 11, 13, 14, 16, 17, 18, 19, 21, 22, 24, 27, 30, 32
2375M	E4, E5, E6, E7, E8	1900	6x7, 8x9, 10x11, 12x13, 14x15, 16x17, 18x19, 20x22, 21x23, 24x27, 25x28, 30x32
4375M	E10, E12, E14, E16, E18, E20	1970	6x7, 8x9, 10x11, 12x13, 14x15, 16x17, 18x19, 20x22, 24x27, 30x32
4435M	10, 11, 12, 13, 14, 17, 19, 21, 22, 24	75°	75°
275555G	2792	1421	PH1 x 80, PH2 x 38, PH2 x 100, PH3 x 150
2177NU	257145	1422	3 x 75, 4 x 100, 5.5 x 125, 6.5 x 38, 6.5 x 150, 8 x 175
245205F	222102, 222104	361112P	651110
4335M	8, 9, 10, 11, 12, 13, 14, 15, 16, 17, 18, 19, 20, 21, 22, 23, 24, 25, 26, 27, 28, 29, 30, 32	782130CS	782130CS
4635	16, 20.8	764G	Ø 2, Ø 3, Ø 4, Ø 5, Ø 6, Ø 8, Ø 10, Ø 12, Ø 14
475510G	457212		
445218F	4791		
425103, 425105, 425110			
4033	T20, T25, T27, T30, T40, T45, T50, T55, T60		
4035	H4, H5, H6, H7, H8, H10, H12, H14, H17		
1120MR	H1.5, H2, H2.5, H3, H4, H5, H6, H8, H10		
1930	10x11, 12x14, 14x17		
3204	621106		
611108	631106		
68HS07	68HB07		
68SS07	68SB07		
1163	T10H, T15H, T20H, T25H, T30H, T40H, T45H, T50H		
1160M	H2, H2.5, H3, H4, H5, H6, H8, H10		

\*The guarantee is unlimited in time, excludes impact tools

### 325 TOOLS SET

934A011MRVD01

1/4" + 3/8" + 1/2"

€1,290 D



Contents

2335M	4, 4.5, 5, 5.5, 6, 7, 8, 9, 10, 11, 12, 13, 14	1062	6, 7, 8, 9, 10, 11, 12, 13, 14, 15, 16, 17, 18, 19, 21, 22, 24, 27, 30, 32
2235M	4, 4.5, 5, 5.5, 6, 7, 8, 9, 10, 11, 12, 13, 14	1900	6x7, 8x9, 10x11, 12x13, 14x15, 16x17, 18x19, 20x22, 21x23, 24x27, 25x28, 30x32
2375M	E4, E5, E6, E7, E8	1970	6x7, 8x9, 10x11, 12x13, 14x15, 16x17, 18x19, 20x22, 24x27, 30x32
2013X	T8, T9, T10, T15, T20, T25, T27, T30, T40	1143	T10, T15, T20, T25, T27, T30, T40, T45, T50
2015MX	H3, H4, H5, H6, H8	1930	8x10, 10x12, 11x13, 12x14, 17x19, 19x22
2018X	PZ1, PZ2	1120MR	H1.5, H2, H2.5, H3, H4, H5, H6, H8, H10
2011X	PH1, PH2	1421	PH2x38, PH1x80, PH2x100, PH3x150
2012X	3.5, 5.5, 8	1422	3x75, 4x100, 5.5x100, 6.5x100, 10x200, 6.5x38
1025T	T6, T7	1423	T6x48, T7x48, T8x75, T9x75, T10x75, T15x75, T15x250, T20x100, T20x250, T25x100, T25x250, T27x100, T30x125, T30x250
1025M	M4, M5, M6, M8, M10	PH2x300	PH2x300
2792	2813	276A04G	276A04G
222102, 222104, 222106			
3335M	10, 11, 12, 13, 14, 15, 16, 17, 18, 19, 20, 21, 22	1160MR	H2, H2.5, H3, H4, H5, H6, H8, H10
3375M	E7, E8, E10, E11, E12	115H	8, 10, 13
3230M	8, 10, 11, 12, 13, 14, 16, 17, 19	115345R	9CZ101
3750M	10, 11, 12, 13, 14, 15, 16, 17, 18, 19	48280180	43280212
3812, 3814	377908G	43240115V	7540208G
322314		7510208G	7550208G
322103, 322106, 322110		7520208G	7530208G
4335M	8, 10, 11, 12, 13, 14, 15, 16, 17, 18, 19, 20, 21, 22, 23, 24, 26, 27, 28, 30, 32	611106	623107
4375M	E10, E12, E14, E16, E18, E20, E22, E24	631108	631911C
463516R, 463521R		601110R	631405
463014RC		651610C	
4791	477910G	67HS07	68SB07
429302	425105, 425110	67HB07	68SS07
1636H	H5, H6, H7, H8, H10, H12	7610405	
1636M	M6, M8, M10, M12	7621706, 7622007	
1636T	T30, T40, T45, T50, T55, T60	7640305, 7640406, 7640565, 7640607	
1832H	H3, H4, H5, H6, H7, H8, H10, H12	782130	
1832T	T15, T20, T25, T27, T30, T40, T45, T50	9DC23	212118
1836P	PH2, PH3	796204	796304
1836S	9 x 1.6, 11 x 2		
1880P	PH2, PH3		
1880S	8 x 1.2, 10 x 1.6		
414810M, 414810S	4112		

\*The guarantee is unlimited in time, excludes impact tools, measuring tools, power tools, pullers, wire brush, and file.



# STORAGE AND TOOL SETS

## 263 TOOLS SET

934263MRED

1/4" + 1/2"

€1,569 <sup>D</sup>



Contents

2335M	4, 4.5, 5, 5.5, 6, 7, 8, 9, 10, 11, 12, 13	1061	6, 7, 8, 9, 10, 11, 12, 13, 14, 15, 16, 17, 18, 19, 20, 21, 22, 23, 24, 25, 26, 27, 28, 29, 30, 32
2375M	4, 5, 6, 7, 8	1147R	T10, T15, T20, T25, T27, T30, T40, T45, T50
275555G	257145	1120MR	H1.5, H2, H2.5, H3, H4, H5, H6, H8, H10
245205F	2792	1461	PH2 x 75, PH2 x 100, PH3 x 150
222102, 222104	2177DF	1421	PH2 x 38
2142	4112	1462	5.5 x 100, 6.5 x 150, 8.0 x 175
1025P	PH1, PH2, PH3	1422	6.5 x 38, 3 x 75, 4x 100, 10.0 x 200, 12 x 250
1025Z	PZ1, PZ2, PZ3	2121A18	
1025H	3, 4, 5, 6	361115	320670
1025U	T7H, T8H, T9H, T10H, T15H, T20H, T25H, T27H, T30H, T40H	9TK112	
1832H	H3, H4, H5, H6, H7, H8, H10, H12	6CB21	672110
1832T	T15, T20, T25, T27, T30, T40, T45, T50	9DC22	7951212
1636H	H5, H6, H7, H8, H10, H12	7713106	7734020
1636T	T30, T40, T45, T50, T55, T60	7909405M	7906320
1636M	M6, M8, M10, M12	792112	797107
1836S	11 x 2.0, 9 x 1.6	651710C	6AB3175
1836P	PH2, PH3	782180OS	
4335M	8, 9, 10, 11, 12, 13, 14, 15, 16, 17, 18, 19, 20, 21, 22, 23, 24, 25, 26, 27, 28, 29, 30, 32, 33, 36	7640306G, 7640407G, 7640508G, 7640684G, 7640888G, 7641009G, 7641210G, 7641411G	
4375M	E10, E12, E14, E16, E18, E20, E22, E24	7610474G, 7610674G, 7610874G, 7611074G, 7612574G	
402B	M16	7622284G	
4025	H6, H7, H8, H10, H12, H14, H17	7622610GR	
4023	T20, T25, T27, T30, T40, T45, T50, T55, T60, T70	786238	784315
4026	M14, M12, M10, M8, M5	66HS07	66SB07
4027	T30, T40, T45, T50, T55, T60	66HB07	66SS07
4035	H6, H7, H8, H10	611107	621106
4036	M8, M10, M12	631106	
4033	T40, T45, T50, T55, T60, T70	445318F	
4148	414810M (10 mm), 414810S (5/16"), 414808S (1/4")	429305, 429310	4791
477310GS			

\* The guarantee is unlimited in time, excludes impact tools, measuring tools, power tools and cutting tools.

## 281 TOOLS SET

932281MRED

1/4" + 1/2" + 3/4"

€1,507 <sup>D</sup>

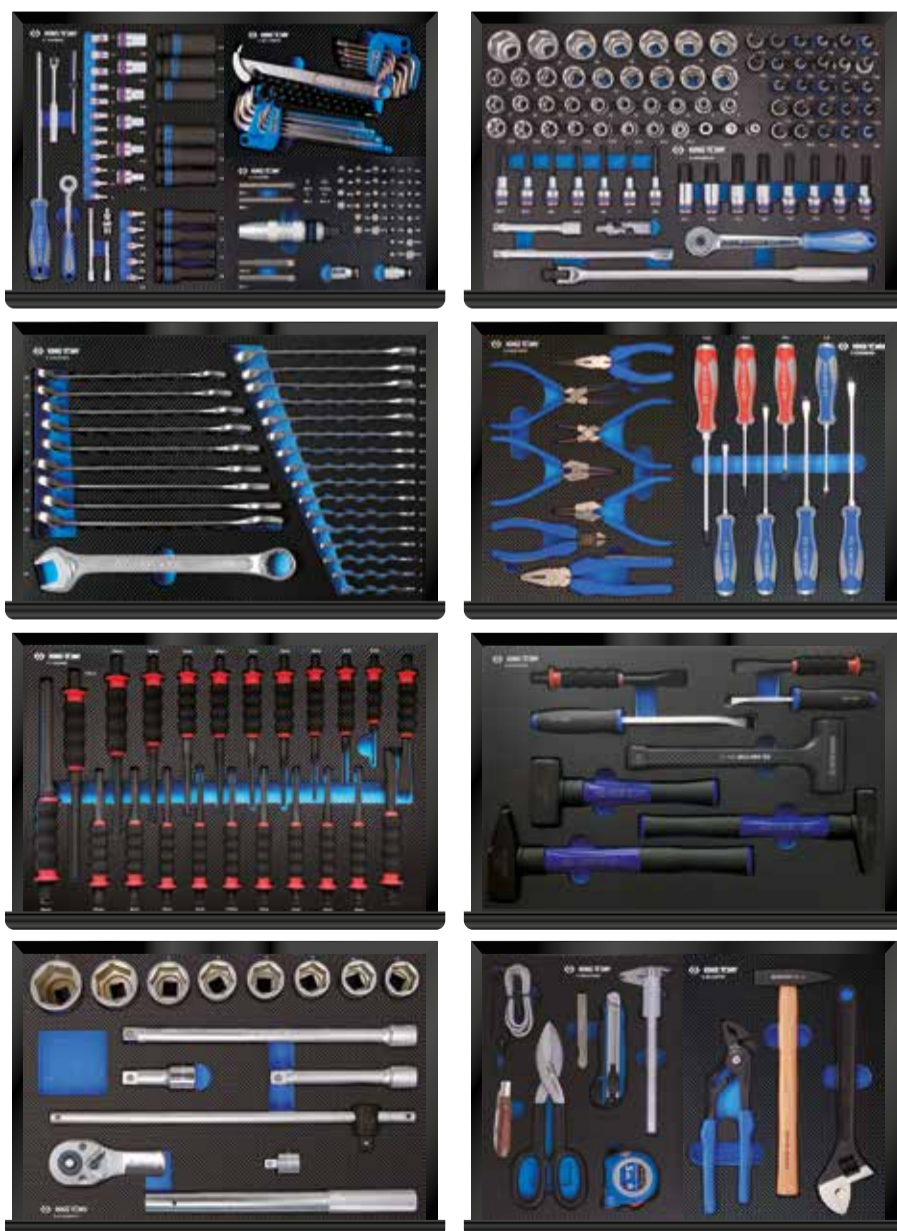

Contents

2335M	4, 4.5, 5, 5.5, 6, 7, 8, 9, 10, 11, 12, 13	1636H	H5, H6, H7, H8, H10, H12
2375M	E4, E5, E6, E7, E8	1636M	M6, M8, M10, M12
4375M	E10, E12, E14, E16, E18, E20	1636T	T30, T40, T45, T50, T55, T60
4435M	10, 11, 12, 13, 14, 17, 19, 21, 22, 24	1832H	H3, H4, H5, H6, H7, H8, H10, H12
275555G	2792	1832T	T15, T20, T25, T27, T30, T40, T45, T50
2177NU	257145	1836P	PH2, PH3
245205F	222102, 222104	1836S	9 x 1.6, 11 x 2
4335M	8, 9, 10, 11, 12, 13, 14, 15, 16, 17, 18, 19, 20, 21, 22, 23, 24, 25, 26, 27, 28, 29, 30, 32, 33, 36	1880P	PH2, PH3
4375M	E10, E12, E14, E16, E18, E20, E22, E24	1880S	8 x 1.2, 10 x 1.6
4025	H6, H7, H8, H10, H12, H14, H17	414810M, 414810S	4112
4023	T20, T25, T27, T30, T40, T45, T50, T55, T60, T70	1461	PH1 x 75, PH2 x 100, PH3 x 150
4026	M5, M8, M10, M12, M14	1462	5.5 x 100, 6.5 x 100, 6.5 x 150, 8 x 150, 8 x 175
4027	T30H, T40H, T45H, T50H, T55H, T60H	611108	621106
4035	H6, H7, H8, H10	631106	
4033	T40, T45, T50, T55, T60, T70	68HS07	68HB07
4036	M8, M10, M12	68SS07	68SB07
402B	M16	361112P	651110
475510G	445218F	782130OS	
429305, 429310	4791	764G	ø3, ø4, ø5, ø6, ø7, ø8, ø9, ø10, ø12, ø14, ø16
414808S, 414810S, 414810M		762G	18, 22 (x2)
6335M	33, 34, 35, 36, 38, 41, 46, 50	761G	ø2.5, ø4, ø6, ø8, ø10
677820FS		763G	ø2, ø3, ø4, ø5
625104, 625108, 625116	6814	9TK108, 9TK112	785116
657220		784310	782027
1062	6, 7, 8, 9, 10, 11, 12, 13, 14, 15, 16, 17, 18, 19, 20, 21, 22, 23, 24, 25, 26, 27, 28, 29, 30, 32	786238	793204
1120MR	H1.5, H2, H2.5, H3, H4, H5, H6, H8, H10	7711106A	7734020
1147R	T10H, T15H, T20H, T25H, T27H, T30H, T40H, T45H, T50H	7909405M	9DC23
3204		797107	74408

\* The guarantee is unlimited in time, excludes impact tools, measuring tools, power tools and cutting tools.

STORAGE AND TOOL SETS

9G33001MRD

1/4" + 3/8" + 1/2"

€2,159 <sup>D</sup>



The mega composition for 6 extra-wide drawers



Contents

- 2335M 5.5, 6, 7, 8, 9, 10, 11, 12, 13, 14
- 4335M 10, 11, 12, 13, 14, 15, 16, 17, 18, 19, 21, 22, 23, 24, 27, 30, 32
- 4235M 8, 9, 10, 11, 12, 13, 14, 15, 16, 17, 18, 19
- 3375M E8
- 4375M E10, E12, E14, E16, E18, E20, E22, E24
- 4033 T55, T70
- 4049 M7, M8, M9, M10, M12, M13, M14, M16
- 4036 M6, M8, M10, M12
- 4035 H6, H8, H10, H12
- 4026 M14, M16, M18
- 1025H H3, H4, H5, H6
- 1025U T10H, T15H, T20H, T25H, T27H, T30H, T40H
- 1025Z P21, P22
- 275555G 475510G
- 257145 2178DF
- 2142 222102, 222104
- 425105, 425110 2792
- 4791 2813 4813
- 3335M 6, 7, 8, 9, 10, 11, 12, 13, 14, 15, 16, 17, 18, 19, 21, 22, 24
- 377108G 345308F
- 329303, 329306 377108G 3792
- 4945MX 17, 19, 21
- 4535M 17, 19, 32, 34, 36
- 4415M 17, 19, 21
- 4435M 10, 11, 12, 13, 14, 15, 16, 17, 18, 19, 21, 22, 24, 27, 30, 32, 33, 34, 36
- 4945MX 17, 19, 21
- 7713308 6A3175
- 9AE32110 (Ø65-120)
- 34440A 34440A 159609
- 344231A (42-100 Nm) 158609
- 1421 PH0 x 60, PH2 x 38
- 1422 3 x 75, 6.5 x 38
- 1461 PH2 x 100, PH3 x 150
- 1462 6.5 x 100, 8 x 150
- 1427 T8H x 75, T10H x 75, T15H x 75, T20H x 100, T25H x 100, T27H x 100, T30H x 125
- 1421 extra long PH2 x 300
- 1422 extra long 6.5 x 300
- 43280212 212118
- 7711106A 7734020
- 7909405M 9DC23
- 793204 797107 74408
- 1062 6, 8, 10, 11, 13, 14, 16, 17, 18, 19, 21, 22, 24, 27, 30, 32
- 3732M 6x7, 8x9, 10x11, 12x13, 14x15, 16x17, 18x19, 20x22, 21x23, 24x27, 25x28, 30x32
- 1025S 3.0, 4.0, 5.0, 6.0
- 1025P PH1, PH2 x 2, PH3
- 1025Z P21, P22 x 2, P23
- 1025T T10, T15, T20, T25, T27, T30, T40
- 1025H H3, H4, H5, H6
- 1025U T10H, T15H, T20H, T25H, T27H, T30H, T40H
- 1025R
- 75363 770225 7732826
- 10D0 10, 12, 13, 14, 17, 18, 19
- 1130MR H2.5, H3, H4, H5, H6, H8, H10
- 1130SR 3/32", 1/8", 5/32", 3/16", 1/4", 5/16", 3/8"
- 1147R T10H, T15H, T20H, T25H, T27H, T30H, T40H
- 276A04G 361106R, 361108R
- 1636H H5, H6, H7, H8, H10, H12
- 1636M M6, M8, M10, M12
- 1636T T30, T40, T45, T50, T55, T60
- 1832H H3, H4, H5, H6, H7, H8, H10, H12
- 1832T T15, T20, T25, T27, T30, T40, T45, T50
- 1836P PH2, PH3
- 1836S 9 x 1.6, 11 x 2
- 1880P PH2, PH3
- 1880S 8 x 1.2, 10 x 1.6
- 414810M 414810S 4112
- 1930 8 x 10, 10 x 12, 11 x 13, 12 x 14, 17 x 19, 19 x 22
- 1636H H4, H5, H6, H7, H8, H10, H12
- 1636T T20, T25, T27, T30, T40, T45, T50, T55, T60
- 1636M M5, M6, M8, M10, M12
- 1680H H4, H5, H6, H7, H8, H10, H12
- 1680T T20, T25, T27, T30, T40, T45, T50, T55, T60
- 1680M M5, M6, M8, M10, M12
- 1127R T10H, T15H, T20H, T25H, T27H, T30H, T40H, T45H, T50H
- 1120MR H1.5, H2, H2.5, H3, H4, H5, H6, H8, H10
- 1120MR H1.5, H2, H2.5, H3, H4, H5, H6, H7, H8
- 1147R T10H, T15H, T20H, T25H, T27H, T30H, T40H, T45H, T50H
- 414710M
- 611107 631106 621106
- 651710C 9TK108, 9TK112
- 785116 784310
- 786238 782027
- 764G Ø 2, Ø 3, Ø 4, Ø 5, Ø 6, Ø 8, Ø 10, Ø 12, Ø 14
- 762G 18, 22

\* The guarantee is unlimited in time, excludes impact tools, measuring tools, power tools and cutting tools.



recommended with

**SQUAD D7**

981 mm



87SQ337BABK **New**

page 22

# TORQUE CONTROL

DELIVERED WITH A CALIBRATION CERTIFICATE

1 YEAR GUARANTEE



TOLERANCE +/- 3%

62 SERIES

## HEAVY DUTY ADJUSTABLE TORQUE WRENCH

DIN ISO 6789 & ASME B107.300-2010. Designed for an easy torque adjustment. ±3% torque accuracy (clockwise). Clockwise (CW) and counter-clockwise (CCW) triggering.



Quick automatic return adjustment



Comfortable rubber handle

PUSH BUTTON



3/4" & 1" No Push Button



	Square drive	Torque range		Graduation	Number of teeth	Total length		
		Nm				mm		
342621DG	1/4"	4-20 Nm	0.1 Nm	0.1 Nm	24	324	640	€106 B
342622DG	1/4"	2-10 Nm	0.1 Nm	0.1 Nm	24	281	560	€102 B
342623DG	1/4"	5-30 Nm	0.5 Nm	0.5 Nm	24	325	640	€112 B
343621DG	3/8"	4-20 Nm	0.1 Nm	0.1 Nm	24	324	640	€106 B
343622DG	3/8"	20-100 Nm	0.5 Nm	0.5 Nm	32	435	1300	€126 B
343623DG	3/8"	10-60 Nm	0.5 Nm	0.5 Nm	32	325	1300	€119 B
344621DG	1/2"	40-200 Nm	1 Nm	1 Nm	32	521	1590	€129 B
344622DG	1/2"	60-340 Nm	2 Nm	2 Nm	32	613	1810	€132 B
344623DG	1/2"	20-100 Nm	0.5 Nm	0.5 Nm	32	435	1590	€130 B
344624DG	1/2"	80-400 Nm	2 Nm	2 Nm	32	613	1970	€128 B
346621DG	3/4"	100-600 Nm	5 Nm	5 Nm	24	1048	5500	€389 B
346622DG	3/4"	150-800 Nm	5 Nm	5 Nm	24	1234	5600	€479 B
346623DG	3/4"	200-1000 Nm	5 Nm	5 Nm	24	1238	6150	€503 B
348621DG	1"	200-1000 Nm	5 Nm	5 Nm	24	1238	6150	€519 B



10 PC.

## 1E10MR 3/8" €87 B

### 3/8" CROWFOOT INSERT SET ON RAIL

Crowfoot inserts. 12 points flare nut. For difficult access.

Contents: 3/8" 10, 11, 12, 13, 14, 15, 16, 17, 18, 19 mm

Take care to check the torque first



## 34440A 1/2" €34 B

### TORQUE ANGLE GAUGE

The dial allows the operator to precisely tighten to the desired angle. Transparent composite plate with integrated pointer, 360° angle scale clearly marked in 2° increments, and in intervals of 10° and 30°, protecting the dial from dirt and grease.



TOLERANCE +/- 3%

## 348622DG 1" €854 B

### HEAVY DUTY ADJUSTABLE TORQUE WRENCH

DIN ISO 6789 & ASME B107.300-2010. Designed for an easy torque adjustment. ±3% torque accuracy (clockwise). Clockwise (CW) and counter-clockwise (CCW) triggering.

	Square drive	Torque range Nm	Graduation	Total length mm	
348622DG	1"	300-1500 Nm	10 Nm	1850	12200



TOLERANCE +/- 2%

## 344171A 1/2" €155 B

### ANGLE TORQUE ADAPTER

Contents: torque and angle adapter, 1 control adapter, one 1/2" x 1/4" adapter and one 1/2" x 3/8" adapter.

1x CR2032 included



67 SERIES

## ELECTRONIC TORQUE WRENCH

Electronic torque value readout. Peak hold and track mode selection. Buzzer and LED indicator for presetting target torque. Engineering units (Nm, ft.lb, in.lb, kgf.m) adjustment. Switch off automatically after 80 seconds. DIN ISO 6789 & ASME B107.300-2010. CW ±2% and CCW ±3% operation.

TOLERANCE +/- 3%

	Square drive	Torque range			Length mm			
		Nm	ft. lb.	in. lb.				kgf.m
343672AG	3/8"	27-135 Nm	19.9 - 99.6 ft.lb.	239-1195 in.lb.	2.75-13.76 kgf.m	460	1300	€159 B
344671AG	1/2"	40-200 Nm	29.5-147.5 ft. lb.	354-1770 in. lb.	4.08-20.38 kgf.m	530	1500	€190 B

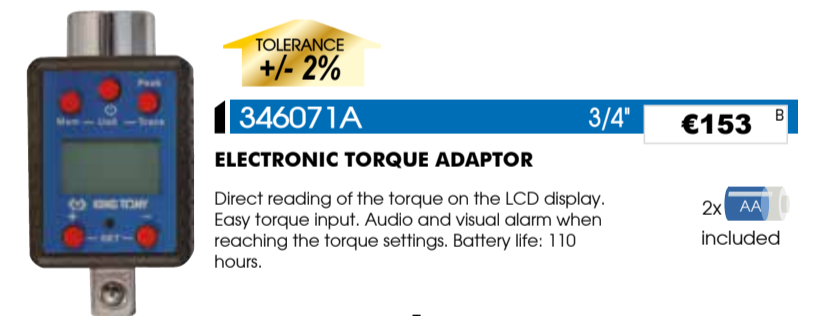

TOLERANCE +/- 2%

## 346071A 3/4" €153 B

### ELECTRONIC TORQUE ADAPTOR

Direct reading of the torque on the LCD display. Easy torque input. Audio and visual alarm when reaching the torque settings. Battery life: 110 hours.

2x AA included

	Square drive	Torque range			Memory	
		Nm	Incr. ft.lb	kgf.m		
344171A	1/2"	40-200 Nm	0.1 Nm	29.5-147.5 ft.lb	4.08-20.38 kgf.m	10
346071A	3/4"	200-1000 Nm	0.1 Nm	147.6-738 ft.lb	4.08-20.38 kgf.m	50

## INTERCHANGEABLE TORQUE WRENCH SET



8 PC.

## 345102D08MR 4~20 Nm €199 B

## 345104D08MR 10~60 Nm €214 B

Contents: 345102D08MR → 345122DG (4-20 Nm), 345104D08MR → 345124DG (10-60 Nm). 328 x 123 x 60 mm. TOLERANCE +/- 3%

	End fitting mm	Torque range Nm	Graduation	Length mm	
345122DG	9 x 12	4-20 Nm	0.1 Nm	306	590
345124DG	9 x 12	10-60 Nm	0.5 Nm	306	590



11 PC.

## 345202D 11MR 40~200 Nm €309 B

## 345203D 11MR 60~340 Nm €319 B

Contents: 345202D 11MR → 345222DG (40-200 Nm), 345203D 11MR → 345223DG (60-340 Nm). 618 x 153 x 65 mm. TOLERANCE +/- 3%

	End fitting mm	Torque range Nm	Graduation	Length mm	
345222DG	14 x 18	40-200 Nm	1 Nm	485	1410
345223DG	14 x 18	60-340 Nm	2 Nm	580	1590



## TORQUE CONTROL

1 YEAR GUARANTEE



Suitable for 1/4" Hex insert bit

TOLERANCE +/- 5%



341112DG

1/4"

€127 B

### TORQUE SCREWDRIVER

DIN ISO 6789 & ASME B107.300-2010.  
Easy-to-read laser scale.  
Ergonomic and comfortable rubber grip.  
High quality aluminum alloy.  
Torque accuracy tolerance ±5%.



Set torque using the blue band

Code	Size	Torque range Nm	Incr.	Length mm	Weight kg
341112DG	1/4"DR.	1.5 - 6.5 Nm	0.1 Nm	196	475



Use with impact socket.  
Do not use with an energized tool (impact wrench, ...).  
Do not use an extension bar.

540 Nm max.  
3/4"

2700 Nm max.

3468805A

5:1

€489 B

### 5:1 TORQUE MULTIPLIER

Accuracy: ±5% at least.  
2 types of reaction bar (straight and angled).

1/2" 173 Nm max.  
4500 Nm max.

Rotary angle gauge

3448826

26:1

€1,780 B

### 26:1 TORQUE MULTIPLIER

Accuracy: ±5% at least. Anti-backlash.  
2 types of reaction bar (straight and angled).

## DRILL BIT, TAP, DIE



28 PC.

11328SQ

€113 B

### DRILL BIT AND TAP SET

HSS steel.

Contents	Weight kg
2.5, 3.3, 4.2, 5, 6.8, 8.5, 10.2	0.96
M3, M4, M5, M6, M8, M10, M12	



54 PC.

13954MQ

€606 B

### TAP AND DIE SET

HSS steel.

Contents		Weight kg
M3x2.5	M12x10.2	20x5, 20x7, 25x9, 30x11, 38x14, 45x18
M4x3.3	M14x12.0	1xN°1, 1xN°3
M5x4.2	M16x14.0	
M6x5.0	M18x15.5	
M8x6.8	M20x17.5	
M10x8.5		



39 PC.

12939MQ1

€109 B

### TAP AND DIE SET

SK5 high carbon steel

Contents		Weight kg
M3x0.5	M6x0.75	M10x1.25
M3x0.6	M6x1.0	M10x1.5
M4x0.7	M7x0.75	M12x1.5
M4x0.75	M7x1.0	M12x1.75
M5x0.8	M8x1.0	M12x1.75
M5x0.9	M8x1.25	1/8NPT27
0.5, 0.6, 0.7, 0.75, 0.8, 0.9, 1.0, 1.25, 1.5, 1.75, 2.7, 2.8		25 mm (1")
4NS36	1/4NC20	7/16NC14
6NC32	1/4NF28	7/16NF20
8NC32	5/16NC18	1/2NC13
10NC24	5/16NF24	1/2NF20
10NF32	3/8NC16	1/8NPT27
12NC24	3/8NF24	
12, 13, 14, 16, 18, 20, 24, 27, 28, 32, 36, 40		M3-M12 (1/8"-1/2")
		M3-M6 (1/8"-1/4")



### 3912 RATCHET BIT-HOLDERS



For taps and screw extractors.

Code	mm	D mm	Tap capacity	Ø mm	Weight kg
39123010MD	3/8"	34.4	M1-M7	2 ~ 7	221
39123012MD	1/2"	34.4	M5-M14	4 ~ 9	223
39124012MD	1/2"	38.5	M5-M8	5 ~ 8	259

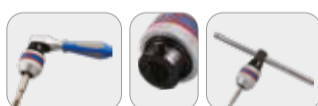

For use with a ratchet or T-handle.

## PULLERS

New

3 PC.



9TD033MR

1/2"

€48 B

### 1/2" HELICAL SOCKETS FOR DAMAGED NUTS

Designed for used nuts or nuts rounded by time. Sockets made of SNCM (Silicon Nickel Chrome Molybdenum).

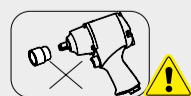

Do not use these sockets with an impact wrench.

Contents	Weight kg
9TD403	17, 19, 21 mm

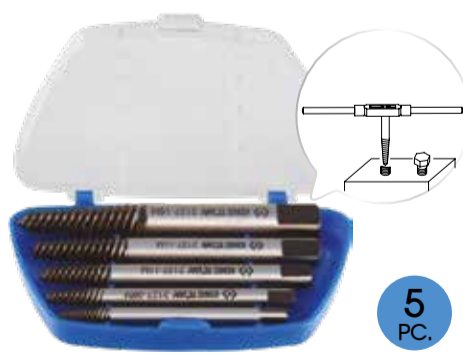

5 PC.

11205SQ

€13 B

### SCREW EXTRACTOR SET

For internal stud extraction.

Use with:



Contents	Weight kg
3911ML, 3740ML, 3912M	0.1
9BE2127	M3-M6, M6-M8, M8-M11, M11-M14, M14-M18



1 Drill

2 Extract

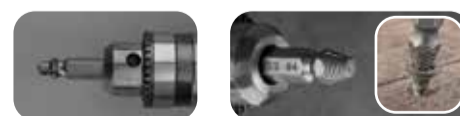

11406SQ

6 PC.

€16 B

### DOUBLE ENDED SCREW EXTRACTOR SET

For removing damaged, broken, rusty, jammed screws.  
To be used with a powered drill. Drill a hole on a damaged screw, then extract it using the other end of the extractor.  
Contains 6 extractors from 2 to 12 mm to meet the most common situations. Manufactured from high hardness HSS for easier and faster drilling.

Contents	Ø H1	Ø H2
#0	2.5	2-3mm
#1	3.0	3-5mm
#2	3.5	4-8mm
#2	3.5	4-8mm
#3	4.0	5-10mm
#4	6.0	6-12mm





## AUTOMOTIVE TOOLS

### LUBRICATION



One-hand use

**9BU1432T 400 cc €48 B**

#### GREASE GUN WITH HANDLE

400 cc capacity.  
Work pressure: 310 bars (max 490 bars).  
Flexible hose and fixed metal nozzle.  
Comfortable handle.  
Length: 267 mm.  
1,36 kg.



**9BU241T 400 cc €41 B**

#### LEVER GREASE GUN

Cartridge capacity 400 cc.  
Work pressure: 310 bars (max 700 bars).  
Fixed metal hose and flexible hose.  
Comfortable handle.  
Length: 360 mm.  
1,24 kg.

### CLEANING

#### PNEUMATIC BLOW GUN

Steel nozzle. Nylon fiber handle.

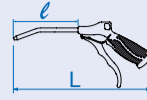

copper thread

	Longueur de la buse mm	Total length mm	Air inlet Inch	Air pressure bar	Air consumption L/min	Noise DBA	Weight g	
7990004	100	245	1/4"	6.2	350	85	200	€7 B
7990010	250	420	1/4"	6.2	350	85	240	€9 B
7990013	330	475	1/4"	6.2	350	85	260	€10 B
7990020	500	650	1/4"	6.2	350	85	300	€12 B

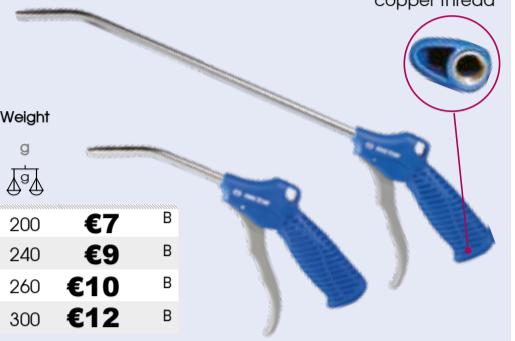

#### PNEUMATIC SPRAY GUN

Suitable for spraying a wide range of oils, cleaners and anti-rust liquids.  
Equipped with a fluid / air regulating valve.



	Capacity L	Working pressure bar	Working pressure psi	Air inlet Inch	Weight g	
7998206	600	6.2 - 10.3	90 - 150	1/4"	600	€23 B
7998210	1000	6.2 - 10.3	90 - 150	1/4"	800	€35 B

7998210

stainless steel

### DRAIN - FILTRATION



**9AE6030 Ø65~120 €178 B**

#### OIL FILTER CUP WRENCH SET

Universal set.  
• 1x extra flat self tightening wrench 9AE42 (65-120 mm)  
• 1x 1/2" F to 3/8" M adaptor  
• 28x 1/2" cup wrenches (65-108 mm)



**320670 Ø60~180 €30 B**

#### OIL FILTER STRAP WRENCH

Capacity: 60-180mm. Length: 295mm. Strap length: 830mm. Suitable for oil filters and all hose types. Highly resistant nylon strap for better grip. Aluminum alloy handle. 285g



**9AE33110 Ø65~110 €22 B**

#### METAL OIL FILTER STRAP WRENCH

Stamped metal belt for a better grip around the filter. Handle designed for extra comfort. Serrated support.

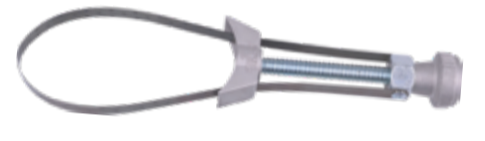

**9AE32110 Ø60~110 €12 B**

**9AE32155 Ø110~155 €14 B**

#### METAL OIL FILTER STRAP WRENCH



**320560 Ø60~160 €56 B**

#### DOUBLE CHAIN FILTER WRENCHES

Flexible handle for narrow areas. Open the chain by simply pressing the head.



**3204 Ø60~140 €18 B**

#### CHAIN OIL FILTER WRENCH

Length: 225 mm.



**9AE43 Ø75~120 €23 B**

#### SELF-TIGHTENING WRENCH

3/8" square drive. Adapter 1/2" F to 3/8" M. Reinforced frame. 603,5 g.



**9AE52 Ø60~80 €68 B**

#### SELF-TIGHTENING WRENCH

1/2" Square drive. Electro-black oxide finish for rust protection.

**9AE52110 Ø80~110 €108 B**



**9AR21 €11 B**

#### OIL DRAIN PLUG FOR VAG

Used to remove or install plastic oil drain plugs on the latest VAG vehicles. Weight: 20 g.



**158609 €5.20 B**

#### DRAIN PLUG WRENCH

Sizes: 8 ans 10 mm. Length: 230 mm. Chromed finish. 320 g.

### FRONT AXLE



400 mm

**9BE52 €109 B**

#### SELF-TIGHTENING TRACK ROD END REMOVER

Allows installation and removal of the axial direction hinges without removing the rack. Can fully separate the head from the rod to change the orientation of the direction's trajectory. Hex drive. Capacity: 35-45 mm. Ø 90 mm. Length: 400 mm.



**9BE62 Ø33~42 €63 B**

**9BE63 Ø42~50 €68 B**

#### AXIAL DIRECTION BALL UNLOCKING TOOL

Allows installation and removal of the direction axial ball without having to remove the rack. Serrated inside for perfect grip. Can be used with 1/2" ratchets and extensions. Suitable for most of light vehicles and trucks.



**9BH1000 €199 B**

#### FRONT AXLE LEVER BAR

Designed to remove the head from the bottom wishbone. Positioned under the body of the vehicle. Avoids dismantling the spindle or the wishbone. Manual assembly, simple, fast and safe.

	Capacity (kg)	Maximum height (mm)	Length (mm)	Width (mm)	Max chain length (mm)	
9BH1000	200	300	1000	130	250	6

## AUTOMOTIVE TOOLS

### WHEELS



20 PC.

#### WHEEL LOCK SCREW SOCKET SET

This set allows professional mechanics to maintain wheels equipped with anti-theft nuts. Made of chrome-molybdenum (CrMo). Alloy steel chrome plated. Work 17mm hex tool.

#### 9BW0120 VW €225 B

Applicable for installing and removing locks of most VW models.

Contents

2.9

#521, #522, #523, #524, #525, #526, #527, #528, #529, #530, #531, #532, #533, #534, #535, #536, #537, #538, #539, #540

#### 9BW0220 BMW €212 B

Applicable for installing and removing locks of most BMW models.

Contents

1.94

#041, #042, #043, #044, #045, #046, #047, #048, #049, #050, #051, #052, #053, #054, #055, #056, #057, #058, #059, #060



20 mm

146 mm

185 mm



#### 9BM2210A €82 B

#### 3 IN 1 TYRE INFLATOR

Diaphragm gauge. Accuracy: ANSI B401.1. Rubber casing to protect the gauge from bumps. 3 functions on the handle: pressure check, deflation, inflation. 400 mm flexible rubber hose for high pressure. Standard air chuck for cars. Long air chuck for hard to reach valves: suitable for trucks, buses and tractors. Pressure range: 0-15 Bars (0-220 PSI). Integrated hook for easy storage. Air inlet: 1/4". Air hose: 3/8". 600 g.



#### 3488A03MP €142 B

#### 1:47 TORQUE MULTIPLIER

Ideal for loosening wheel bolts on HGVs, buses, agricultural or civil engineering machinery. Manual torque multiplier. Compact, robust and designed for professional use. Delivered with two hex impact sockets 32-33 mm. Ratio: 1:47. Max applied torque 4700 Nm. 9.3 kg.



### ENGINE

For

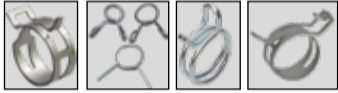

#### 9AA11 €19.30 B

#### STRAIGHT PLIERS FOR SELF-LOCKING COLLARS

The swivel jaws are designed to install and remove hose clamps. Compatible with Audi & VW



#### 9AA31 €66 B

#### FLEXIBLE PLIERS FOR SELF-TIGHTENING CLAMPS

630 mm flexible extension. For replacing hose clamps in hard to reach areas.

528 g



#### 9AA32 €94 B

#### FLEXIBLE HOSE CLAMP PLIERS

700mm long Flexible. Used to remove and install spring clamp. Flexible flat jaw with greater access in confined spaces. Suitable for universal cars, especially VW, Ford, Nissan.

755.6 g

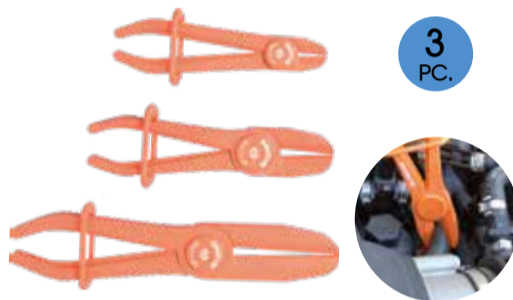

3 PC.

#### 9AF113 €23 B

#### HOSE CLAMP PLIERS SET - 3 PCS

Adjustable jaws to prevent damage to the hose. For 15 mm to 60 mm hoses. Useful for blocking radiator, heating, fuel, coolant and brake hoses.

Contents

0.24

Ø22.4 x 155, Ø35.4 x 185, Ø65.2 x 253 mm



#### 9BB13 €76 B

#### BOOT CLAMP PLIERS

Boot clamp pliers for stainless steel drive shafts. Can be used with a 3/8" torque wrench. Suitable for Audi, VW, Ford and Vauxhall. Capacity: 45 mm. Length: 278 mm. Weight: 887 g.



#### 9BP21 €34 B

#### EXHAUST CLAMP PLIERS

For Citroën/Peugeot. Pliers can be locked in open position. Capacity: 60 mm. Length: 300 mm.



#### 9DB201 €10 B

#### SPARK PLUG BOOT PLIERS

Safely removes spark plug cables. Covered head to prevent cable damage. PP Handle. Capacity: 14-18 mm. Length: 260 mm. Weight: 266g.



#### 9AC23154 €38 B

#### CYLINDER HONE

For lapping and polishing engine cylinders from 50 mm to 175 mm. Easy to change honing stone. Easy spring tension adjustment. Medium grit 220 honing stone.

700 g

#### 9TQ11 €173 B

#### PORTABLE VIDEOSCOPE

5.5mm lens with 6 LED, can be used for shooting video or taking photo (1080P HD Camera 1920 x 1080 resolution). Suitable for visually inspecting areas that are difficult to access over a great distance. 4.3 inch LCD display with 1080P resolution. Rechargeable battery: 2600 mAh Li-ion. Autonomy: 3 hours of continuous.

740 g



#### 9TQ11P02 €75 B

#### 3,9MM INSPECTION CAMERA OF 9TQ11

3.9 mm lens with 6 LED, can be used for shooting video or taking photo (1080P HD Camera 1920 x 1080 resolution)

#### 9TQ12 €66 B

#### WIFI PORTABLE VIDEOSCOPE

Before use, download the Inskam APP, available for IOS & Android. 5.5mm lens with 6 LED, can be used for shooting video or taking photo (1080P HD Camera 1920 x 1080 resolution). Suitable for visually inspecting areas that are difficult to access over a great distance. Rechargeable battery: 1800 mAh Li-ion. Autonomy: 4 hours of continuous.

331 g





AUTOMOTIVE TOOLS

ACCESSORIES

New

9TQ02

€29 B

3 IN 1 LED FLEXIBLE PICK UP TOOL

0.203



- 1 To pick up hard to reach nuts and bolts.
- 2 Inspection mirror: 50 x 25 mm. To inspect hidden or narrow areas. Pivoting mirror with double ball joint.
- 3 Light head

2x AA not included

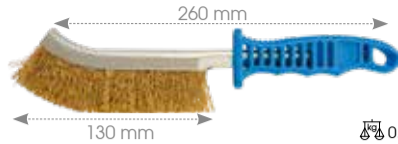

9CZ201 €3.80 B

**CURVED WIRE BRUSH - CORRUGATED STEEL WIRES**  
For brushing jobs such as deburring, cleaning, derusting, smoothing, and flexibility requiring tasks.



30914AY €12 B

**HOOK SET**  
To scribe, align, install and remove o-rings, gaskets, cotter pins and washers.



87C23AB €59 B

**PLASTIC CREEPER**  
Practical, with a transport handle and two side storage trays to easily reach tools and small parts. Cushioned foam head support with vinyl cover for user comfort. 6 swivel wheels. 102 cm. Robust: plastic one-piece construction. Ground clearance: 6.35 mm.

COOLANT



7 PC.

9AM012

€332 B

**UNIVERSAL COOLING SYSTEM PRESSURE TESTER**

3.4

Makes checking for radiator leaks easy. Professional design, high-pressure resistant. Special hose hooks for quick replacement.

Works without adaptor thanks to its rubber cone which adapts to fit perfectly all diameters from 17 to 40 mm.



For quickly changing coolant vacuum.



Universally suitable : MB, GM, Jeep, Peugeot, Subaru, Chrysler, Acura, Mitsubishi, Nissan, Mazda, Toyota, Infiniti, Suzuki, Isuzu, Honda, Acura, Lexus, Volvo, Saab, Citroën, Renault, Fiat, Alfa, Mini Cooper, BMW, Ford, Vauxhall, Porsche, etc....

SUSPENSION



8 PC.

9BF31 €579 B

**SPRING COMPRESSOR SET**

Developed for the MacPherson spring coil, delivered with 3 sets of interchangeable 1-component cups. Max torque: 350 Nm. Compression power: 450 kg / 4410 Nm. Capacity: 40-300 mm. Length: 460 mm.

Suitable for: BMW, Ford, VW, Audi, Porsche, Saab, Vauxhall, Volvo, Nissan, Honda, Mitsubishi, Subaru, Toyota.

15

Ø 110-150 mm Ø 80-115 mm Ø 140-195 mm

BRAKES



5 PC.

9BC4A05MP 1/2" €46 B

**BRAKE CALIPER SOCKET SET**

Brake caliper sockets for Volkswagen, Audi and Porsche (VAG) vehicles.  
10-teeth sockets: Ø 11.5 mm, Ø 15 mm, Ø 20 mm.  
7-teeth socket: Ø 14 mm, Ø 22 mm.

0.587



Contents	Number of teeth	Ø (mm)	Vehicle brand and type
9BC42A11	10 teeth	11.5	Porsche
9BC42A15	10 teeth	15	Audi Q7, S8 & Porsche Macan, Cayenne, Cayman
9BC42A20	10 teeth	20	Audi A8, S6 & Porsche Cayenne
9BC41A14	7 teeth	14	Audi Q7, S4
9BC41A22	7 teeth	22	Audi S5

New



6 PC.

9BC5001MR €108 B

**BRAKE BLEEDER WRENCH SET**

Wrench dimensions: 7, 8, 9, 10, 11 mm. Ideal for bleeding the brake system and hydraulic clutch system without removing the wheels. Internal sealing made of high quality material to improve durability.

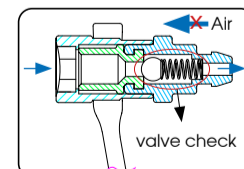

Integrated valve check, preventing the backflow of air into the braking system.



Can be used on any vehicle, SUV, van or motorcycle brake callipers.



Combined wrench and socket to facilitate loosening and tightening.



Silicone tube resistant to acidic and alkaline liquids, corrosion, wear and extremes temperature.

9BC23

€213 B

**DISC BRAKE REWIND TOOL SET**

For rotating pistons back into the caliper to provide clearance for new brake pads. Prevent damages to the pistons and caliper.

CONTENTS:

- 21x piston adaptors
- 3x reaction plates
- 1x 3/8" rotating square drive for caliper (left)
- 1x 3/8" rotating square drive for caliper (right)
- 2x hex keys: 7, 8 mm
- 2x punches: 5.5, 6 mm
- 1x 3/8" hex bit socket: 12 mm

Suitable for BMW, Ford, VW, Audi, Porsche, Saab, Opel, Volvo, Jaguar, Citroën, Peugeot, Renault, Vauxhall, Lancia, Alfa Romeo, Fiat, Nissan, Honda, Subaru, Toyota, Mitsubishi.



4.87



9BC251A01 €91 B

**PNEUMATIC DISC BRAKE WIND-BACK TOOL**

Increased space. Slim version. Designed to facilitate brake disc change operations. The tool can be turned left and right - suitable for regular and reverse thread pistons.

1.35





## AUTOMOTIVE TOOLS

### BODYWORK

**9CF120** €29<sup>B</sup>

**9CF110** €29<sup>B</sup>

**9CF210** €26<sup>B</sup>

**9CF241** €22<sup>B</sup>

**9CF132** €26<sup>B</sup>

**9CF240** €24<sup>B</sup>

**9CF220** €26<sup>B</sup>

**9CF230** €23<sup>B</sup>

**9CF107** €219<sup>B</sup>

**AUTO BODY REPAIR TOOL SET**

430 x 350 x 95 mm

Contents

9CF130 9CF110 9CF120

9CF240 9CF220 9CF230 9CF210



**9CH212** €191<sup>B</sup>

**PNEUMATIC DENT PULLER**

- 1.36 kg sliding hammer.
- 2 pads (120mm, 150mm).
- Brass valve.
- 1/4" air plug.
- 325mm length inlet hose.
- Air exhaust from the handle.
- Working pressure: 6.3 bar.
- Weight: 3.5 kg.



**9TY120040A** 4T €266<sup>B</sup>

**4-TONS BODYWORK REPAIR KIT**

- 4-tonne hydraulic jack with lever and hose
- Hydraulic extension bars : 82, 125, 215, 418, 495 mm
- Hydraulic spreading wedge
- Push ram
- Set of sheet metal reshaping tools



**43240115Y1** €7.30<sup>B</sup>

**WIDE SCRAPER**

Remove old seals more easily and quickly. 150 x 260 mm. Weight : 149 g.



6 PC.

**9CI016** €29<sup>B</sup>

**TRIM REMOVAL SET - 6 PCS**

Ideal for removing inside door handles, door trims, dashboard trims. Thin profile. For easily removing door trims.



3 PC.

**9CJ023** €31<sup>B</sup>

**STAINLESS STEEL BOLSTERED SCRAPER SET**

3 engineer's 32 to 50 mm-wide scrapers, including one bent scraper. Metal impact zone. Total length: 218 mm. 175 x 259 x 30 mm



3 PC.

**9CJ033** €22<sup>B</sup>

**STAINLESS STEEL PINCHWELD SCRAPER SET**

3 Engineers' scrapers special welders' type width of 12 to 19 mm Total length: 168 / 218 mm. 175 x 259 x 30 mm



**9TY12010AB** 10T €379<sup>B</sup>

**10-TONS BODYWORK REPAIR KIT**

- 10-tonne hydraulic jack with lever and hose
- Hydraulic extension bars : 100, 200, 300, 550 mm
- Hydraulic spreading wedge
- Push ram
- Set of sheet metal reshaping tools

### ALTERNATOR



22 PC.

**9DA022** €109<sup>B</sup>

**PULLER SET FOR DETACHABLE ALTERNATOR PULLEYS**

For mounting and removing detachable alternator pulleys. Designed for Bosch, Valeo, Magnetic Marelli and Denso alternators. Also suitable for VW, Audi, Citroen/Peugeot, Mercedes, Renault, BMW, Fiat, Ford and Toyota

### SPARK PLUGS



6 PC.

**3716MR** 3/8" €79<sup>B</sup>

For diesel engine Glow plugs. Sockets have a ball retainer to hold them in place.



**9DM1A1** 3.5-24V €80<sup>B</sup>

**DIGITAL GLOW PLUG TESTER**

Suitable for steel and ceramic spark plugs (3.5, 4.4, 5, 7, 8.5, 10, 11, 24 V). LCD display. Short circuit and reverse charge protection. Automatic stop: 110 seconds. 135 x 78 x 33 mm. 356 g.



1x 9V included

# HYDRAULIC - LIFTING



2 YEAR GUARANTEE

## HYDRAULIC BOTTLE JACK WITH SINGLE LIFT ARM AND EXTENSION SCREW

- All models can be used from -20°C to 70°C
- Can also be used horizontally as a pressure cylinder
- The piston pump must be placed below the jack
- Integrated safety valve
- Galvanised pump handle
- With a raised column to fully benefit from the length of the extension



	Capacity (Tonnes)	Minimum height (mm)	Maximum height (mm)	Hydraulic lifting (mm)	Column (mm)	kg		
9TY111035A	3.5 T	172	372	112	88	3,7	€69	B
9TY11105A	5 T	212	468	146	110	4,9	€73	B
9TY11110A	10 T	220	483	148	115	7,3	€109	B
9TY11115A	15 T	231	498	154	113	9,8	€131	B
9TY11120A	20 T	241	521	165	115	13,1	€160	B



Always support the vehicle on axle stands before working under it. Never stay in or get on a raised vehicle or under one held only by a jack.



2 YEAR GUARANTEE

## SET OF 2 STANDARD AXLE STANDS

- Robust for maximum stability and life
- Adjustable height

	Capacity (Tonnes)	Minimum height (mm)	Maximum height (mm)	kg	
9TY32103A	3 T	375	555	4.45	€83 B
9TY32105A	5 T	395	665	11.4	€235 B
9TY32115A	15 T	625	980	25	€529 D

Limited quantity

## 9TY133A25AB

€273 B

### HYDRAULIC TROLLEY JACK

Hydraulic speed regulating. Low profile design.

2 YEAR GUARANTEE

Double pump for a quicker lifting

	Capacity (Tonnes)	Minimum height (mm)	Maximum height (mm)	kg
9TY133A25AB	2.5 T	90	530	33.8

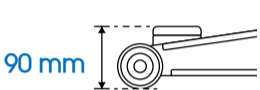

2 YEAR GUARANTEE

## 9TY621AB

€49 B

### ENGINE LEVELER

- Allows easy engine handling and positioning

	Capacity (kg)	Length (mm)	kg
9TY621AB	680	400	5.5

## 9TYVS1

€390 B

### SUPPORT SADDLE



Ratchet clamp 25 x 130 mm

Designed to facilitate the dismantling and positioning of the gearbox on cars and light commercial vehicles.



Cylinder adapter: ø 25, ø 30, ø 35 mm

It can also be used as a support for removing and positioning engine components, in a safe way for the operator. Recommended for working on heavy or bulky components located under the vehicle, such as fuel tanks, transmission shafts, engine cradles, exhaust pipes and differentials.



150 kg maxi

	Capacity (kg)	Height (mm)	Length (mm)	Width (mm)	kg
9TYVS1	150	300	450	310	8

## 9BJ2070

€480 B

### ENGINE SUPPORT

Provides engine or gearbox support when servicing cars and light commercial vehicles. Ideal for changing the timing belt, clutch, alternator, etc.

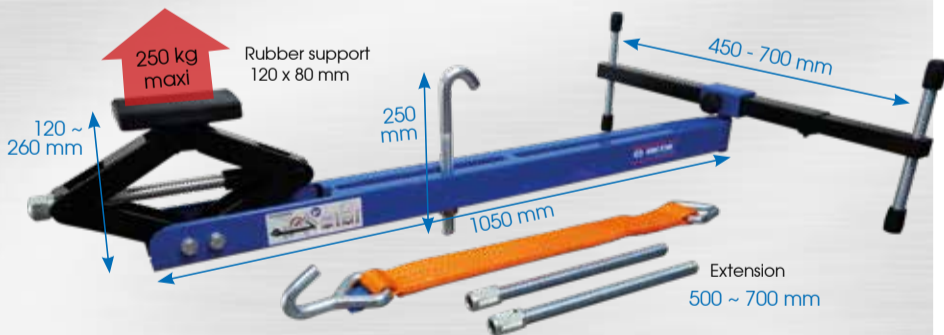

250 kg maxi

Rubber support 120 x 80 mm

450 - 700 mm

250 mm

1050 mm

Extension 500 ~ 700 mm

	Capacity (kg)	Height (mm)	Length (mm)	Width (mm)	kg
9BJ2070	250	200	1060	500	12

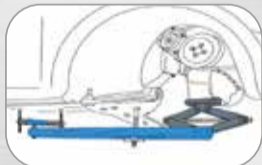

## 9TY61105AB

€157 B

### ENGINE SUPPORT

- Easily supports the engine while removing the Transmission
- Adjustable pad
- The rubber pad prevents sliding while operation

2 YEAR GUARANTEE



	Capacity (kg)	Length (mm)	kg
9TY61105AB	500 kg	1500	22



## 9TY135150AB

€239 B

### ENGINE STAND

- For working on disassembled engines
- 4 adjustable arms (distance and inclination)
- Support pivots 360°
- 5 wheels, including 3 guide wheels, and 2 brakes

360°



2 YEAR GUARANTEE



Folding

# HYDRAULIC - LIFTING

Structure  
**GUARANTEED 10 YEARS**  
Hydraulic system  
**GUARANTEED 3 YEARS**

Please contact your retailer to get a quotation for these items



## 9HYCR2

### HYDRAULIC JACK

- Solid and convenient thanks to the direct lift push on the cylinder
- Large and robust steel frame for a better stability
- Built-in safety overload valve
- Precise and safe control whilst lowering
- Manual dead man's release for optimum safety when lowering
- Complete protection of the cylinder and main parts of the jack
- Ergonomically designed handle ensuring positive and safe operation
- Handle locking system
- Protection of the two directing wheels
- Fitted with quick-lift pedal for easy reach of lifting point
- Noiseless wheels incorporating a polyurethane central O ring offer maximum surface protection.



Quick-lift pedal



Noiseless wheels

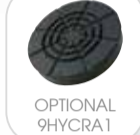

OPTIONAL 9HYCRA1



Capacity (Tonnes)	Min. height (mm)	
2 T	80	31

9HYCR2

Structure  
**GUARANTEED 10 YEARS**  
Hydraulic system  
**GUARANTEED 3 YEARS**

Please contact your retailer to get a quotation for these items



## 9HYCH125H

### AIR HYDRAULIC JACK

- Foldable handle
- Protection of the pneumatic casings in the handle
- Complete protection of the hydropneumatic system
- Hard chromium plated piston rod for long life
- Hand-operated dead-man's control for optimum safety whilst lifting and lowering
- Built-in safety overload valve
- With 2 extensions (50/100 mm)



Extension bar 250 mm

OPTIONAL 9HYCHR25



Saddle Ø 145 mm

OPTIONAL 9HYCHOP1

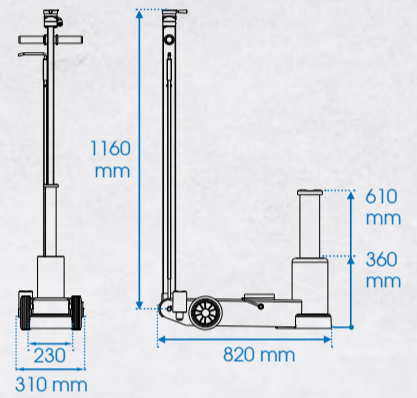

Capacity (Tonnes)	Air supply (bar)	Air consumption (L/min)	
25 T	9 - 12	350	71

9HYCH125H

Structure  
**GUARANTEED 10 YEARS**  
Hydraulic system  
**GUARANTEED 3 YEARS**

Please contact your retailer to get a quotation for these items

## 9HYP40

### HAND HYDRAULIC PRESS

- With 300 mm stroke for dealing with demanding jobs
- Supplied with 2 vee blocks
- Built-in safety overload valve
- Removable ram end cap for mounting various piston heads
- Welded frame and press table made from high strength for long life



Traversing ram.



Winch operated press table.



Foot-operated, double-acting, pneumatically controlled and high speed, leaving both hands free for quick and precise positioning of the item.



Pneumatic approach, manual press (12 bars max.)

Ø 10, 12, 15, 17, 20, 22, 25, 30 mm



OPTIONAL 9HYPA3



OPTIONAL 9HYPP40

OPTIONAL 9HYP1400  
Optional chain driven traction for lifting / lowering of the plate with the cylinder.

Capacity (Tons)	Width L3 (mm)	Height H5 (mm)	Stroke L11 (mm)
40 T	1190	1740	300

Width between legs L12 (mm)	Depth between legs P1 (mm)	Clearance H6 (mm)	
850	215	85 - 785	425

9HYP40

Structure  
**GUARANTEED 10 YEARS**  
Hydraulic system  
**GUARANTEED 3 YEARS**

Please contact your retailer to get a quotation for these items

## 9HYCM15V2

### HYDRAULIC WHEEL TROLLEY

- For easily and comfortably replacing large wheels, even ones with deep tread.
- Just one person can now handle a tyre without needing help.
- Great manoeuvrability thanks to four large robust swivelling wheels.
- Robust safety support to hold the wheel in place during transport.

### HANDLE

Wheel rotation system using the handle. The rollers use the wheel notches to turn the wheel on itself.

**EXCLUSIVITY 9HYCM15V2**



Lever with hydraulic system to control the distance between the rollers that cause the lifting and lowering of the wheel.



System to keep the wheel in place and aligned



Optimal user safety



Notched roll allowing the wheel to roll on itself

Capacity (Tonnes)	Length (mm)	Width (mm)	Height (mm)
1.5 T	1635	1030	1480

Roller length (mm)	Roller distance (mm)	Roller diameter (mm)	Wheel sizes (mm)	Handle	
690	900 - 1650	85	Ø 1000 - 2400	Included	216

9HYCM15V2

**UNRIVALED HANDLING**

## HYDRAULIC - LIFTING



**New**

2 YEAR GUARANTEE

1.5 t

**SECURITY**

**L.C.S**

Table equipped with an automatic lowering adjustment and control system (L.C.S) to avoid sudden movements.



Built-in safety overload valve.



Manual dead man's release for optimum safety when lowering.



The table can be locked at different heights thanks to the safety pins.



Hydraulic stroke limitation.

**9TYC1101500** **€1,875**

**HYDRAULIC LIFTING TABLE**

- Allows lifting, lowering and possibly moving over short distances loads weighing up to 1.5 tonnes.
- "Quick-lift" pump pedal for a quick approach.
- Large ergonomic and non-slip handle facilitating operations.
- Silent polyamide wheels: will not damage garage floors, will not rust, and can facilitate maneuverability.
- Wheels equipped with brakes.



Quick-lift pedal



Noiseless wheels



Capacity (Tonnes)	Minimum height (mm)	Maximum height (mm)	kg
1.5 T	210	880	130

Under no circumstances should you work below a lifted load without having secured it using mechanical supports. This table is equipped with safety pins that allow the table to be blocked at different heights.

Structure GUARANTEED 10 YEARS

Hydraulic system GUARANTEED 3 YEARS

**New**

Please contact your retailer to get a quotation for these items



360°

2 t

**9HYGR20**

**HYDRAULIC WORKSHOP CRANE FOR AUTO WORKSHOPS AND INDUSTRY**

Jib arm with large lifting capacity, even in 5th position.



Capacity (Tonnes)	Minimum height (mm)	Maximum height (mm)	Extraction arm (mm)	kg
2 T	2340	2630	1210 - 1630	250

5 positions = 5 capacities:

- 2000 kg • 1900 kg • 1800 kg
- 1700 kg • 1600 kg



Built-in safety overload valve.



Manual dead man's release for optimum safety when lowering.



Pump rotates through 360° for excellent operation in all working conditions.



Inner frame width enables use with Euro pallets.



Hard chromium plated piston rod and pump piston for long life.

EN 388

CE

2111X

Work gloves

**9TH41**

Lightweight



Synthetic Leather Lightweight

**9TH41L**  
**9TH41XL**

**€16**

**9TH42**

Shockproof



Shock Resistant and Anti-Vibration

**9TH42XL**  
**9TH42XXL**

**€30**

**9TH43**

Non-slip



Silicone Anti-Slip

**9TH43XL**  
**9TH43XXL**

**€26**

**9TH44**

Warm



Work gloves with insulating Thinsulate lining

**9TH44XL**  
**9TH44XXL**

**€30**

**9TH45**

Magnetic



Shock Resistant and Anti-Vibration

**9TH45XL**  
**9TH45XXL**

**€26**

kingtonyeurope.com

service-clients@kingtony.eu

+33 5 49 30 33 27

catalog.kingtony.eu

KING TONY Europe SAS with a capital of € 7 350 000. Compagny registration number: 424 737 138 - FR 26 424 737 138. KING TONY has the right to modify or delete references without notice.

44

Offer valid from 01/07/2023 to 31/12/2023. Recommended retail prices in euros excl. taxes. Non-contractual photographs. Find all our products on catalog.kingtony.eu